

General Data Page 44

RCCBs, Sensitive to Pulsating Currents, Typ A

- Instantaneous tripping Page 49
- Short-time delayed tripping Page 50
- Selective tripping Page 50

RCCBs, Sensitive to Universal Current, Typ B

- Description Page 51
- Technical Data Page 52
- Short-time delayed tripping Page 53
- Selective tripping Page 53

RCBOs

- Technical Data Page 54
- with MCB
- 1-pole + N Page 55
- with MCB 2-pole Page 55



RCCBs
RCBOs

JD Auspice Co.,Ltd.

TEL : 886-2-8991-2796

FAX : 886-2-8991-9298

service@jdauspice.com

http://www.jdauspice.com



Setup and mode of operation of RCCBs

The setup of a RCCB is determined in principle by three function groups:

- 1) Summation current transformer for fault current detection
- 2) Release to convert the electrical measured value into a mechanical tripping operation
- 3) Breaker mechanism with the contacts

The summation current transformer covers all conductors required for carrying current - including the neutral, if necessary. In a fault-free system, the magnetising effects of the current-carrying conductors neutralise each other as regards the summation current transformer, as according to Kirchhoff's law, the sum of all currents is zero. No magnetic field remains which could induce a voltage in the secondary winding.

However, if a fault current flows because of an insulation fault, the equilibrium is disturbed and a magnetic field remains in the transformer core. Because of this, a voltage is created in the secondary winding which switches off the circuit with the insulation fault - via a release and the contact latching mechanism.

This release principle works independently of a supply voltage or an auxiliary power supply.

This is also the prerequisite for the high protection level, which RCCBs offer according to IEC/EN 61008 (VDE 0664). Only with this is it ensured that the full protection effect is retained also in the case of mains disruption, e.g. if an outer conductor fails or if there is an interruption in the neutral conductor.

Short-time delayed tripping K

For electrical loads, which cause high temporary leakage currents when switched on (e.g. via interference suppression capacitors between outer conductor and PE drainage transient fault currents), nuisance tripping of the instantaneous RCCBs can occur when the leakage current exceeds the rated residual current $I_{\Delta n}$ of the RCCB.

For such applications where such loads or interferences cannot be removed or only partly, short-time delayed RCCBs can be used.

The devices have a minimum tripping time delay of 10ms, i.e. they must not trip with a fault current impulse of 10ms duration. Thus the maximum permissible switch off times according to IEC/EN 61008-1 (VDE 0664-10) are kept.

The devices have an increased surge current withstand rating of 3kA.

Short-time delayed RCCBs have the designation K.

Test button

The operational readiness of the RCCB can be checked with a test button which every RCCB has.

On pressing the test button, an artificial fault current is created - the RCCB must release.

Checking the functional readiness by operation of the system and in regular intervals - circa twice a year - is recommended.

The checking dates in the terms or regulations (e.g. accident prevention regulations) must also be observed.

The minimum operating voltage for the test button is 100V AC.

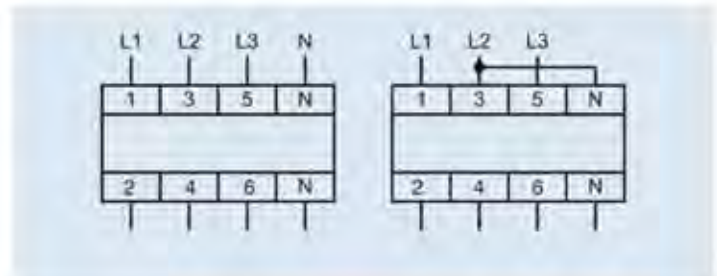

3-pole connection

4-pole RCCBs can also be used in 3-pole systems. Here the connection must be made on terminals 1, 3, 5 and 2, 4, 6.

The function of the test button is only guaranteed if a jumper is fitted in between terminals 3 and N.

Selective tripping S

RCCBs normally have an undelayed tripping operation. This means that a series connection of such RCCBs with the goal of selective tripping does not work.

In order to achieve selectivity with a series connection of RCCBs, the series-connected devices must be staggered not only in the tripping time but also in the rated residual current.

Selective RCCBs have a finite tripping delay. Also, selective RCCBs must have an increased surge current strength of at least 3kA according to IEC/EN 61008-1 (VDE 0664-10).

ABL SURSUM devices have a surge current strength of 25 kA.

Selective RCCBs have the designation S.

RCCBs

General Data

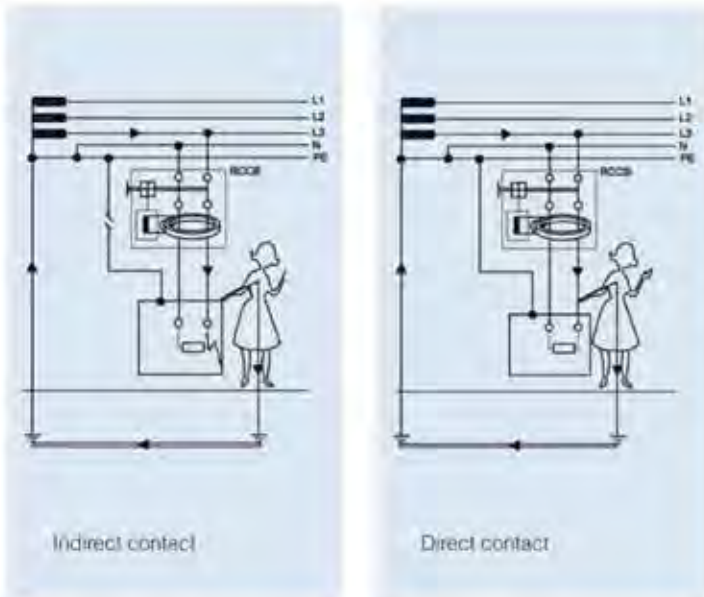

Protection against leakage currents according to DIN VDE 0100 Part 410

Application

- protection against indirect contact (indirect protection against personal injury) – as leakage protection through tripping in the event of higher touch voltages due to short-circuits to frame on equipment.
- when using RCCBs with $I_{\Delta n} \leq 30 \text{ mA}$ also a high degree of protection for direct contact (direct protection against personal injury) – as additional protection due to tripping when live parts are touched.

Protection effect

While devices for a rated residual current of $I_{\Delta n} > 30 \text{ mA}$ offer protection for indirect contact, the use of devices with $I_{\Delta n} \leq 30 \text{ mA}$ achieves an additional high degree of protection as regards accidental contact of active parts.

The permissible tripping time of max. 0.3 s (300 ms) according to VDE 0664 and/or EN 61 008 or IEC 61 008 is not used. RCCBs with rated residual currents of 10 or 30 mA often offer reliable protection if a current flows through the human body in case of accidental direct contact with live parts. This protection effect is not achieved by any other comparable means for protection in case of indirect contact.

In every case of application of the RCCB, an appropriate protective PE conductor must be attached to the equipment and units to be protected. Thus a current through the human body can only occur if there are two faults or by accidental contact of active parts.

The figure alongside shows the physiological reactions of the human body to power flows in the effective current ranges.

The current and time values in region 4 are dangerous because they can cause ventricular fibrillation - leading to the death of the affected person. The tripping region of the RCCB with the rated residual current of 10 mA and 30 mA is also marked.

The tripping time is between 10ms and 30ms on average.

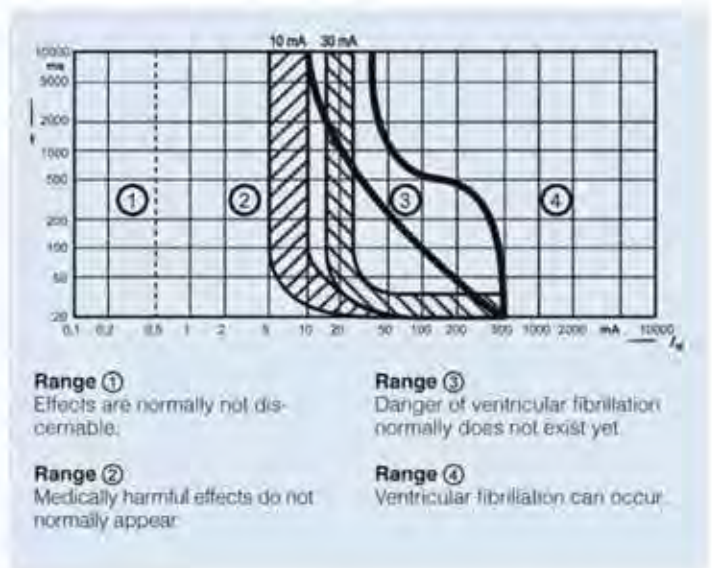

Protection against dangerous leakage currents according to DIN VDE 0100-410

The resistance of the human body depends on the current path. Measurements showed e.g. for a current path from hand/hand or hand/foot a resistance of about 1.000 Ω. For a fault voltage of 230 V AC, a current of 230 mA results for the current path hand/hand.

Earth resistances

When using RCCBs in a TT system, the maximum earth resistances of the table below must be kept – depending on the rated residual current and the max. permissible touch voltage.

Rated residual current	Max. permissible earth resistance at a max. permissible touch voltage of	
$I_{\Delta n}$	50 V	25 V
10 mA	5000 Ω	2500 Ω
30 mA	1660 Ω	830 Ω
100 mA	500 Ω	250 Ω
300 mA	166 Ω	83 Ω
500 mA	100 Ω	50 Ω

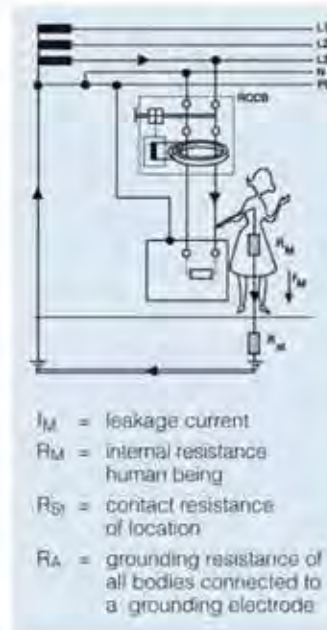

Fire protection according to DIN VDE 0100-482

When using RCCBs with $I_{\Delta n} \leq 300$ mA Protection against formation of electrically ignited fires by insulation faults.

Protection effect

For "industrial premises which are vulnerable to fire", DIN VDE 0100-482 requires measures for the prevention of fires which can occur due to insulation faults. Electrical equipment must be selected and set up, taking into account external influences, so that their temperature rise in normal operation and the foreseeable temperature increase in case of fault cannot cause a fire. This can be achieved by a suitable construction of the equipment or by additional protection measures when setting up.

In TN and TT systems therefore, additional RCCBs with a rated residual current of max. 300 mA are required for "industrial premises which are vulnerable to fire". Where resistance faults can cause a fire (e.g. for overhead heat with panel heating), the rated residual current can be a max. of 30 mA.

The additional protection against fire due to RCCBs should not only be limited to industrial premises which are vulnerable to fire but should be used in general.



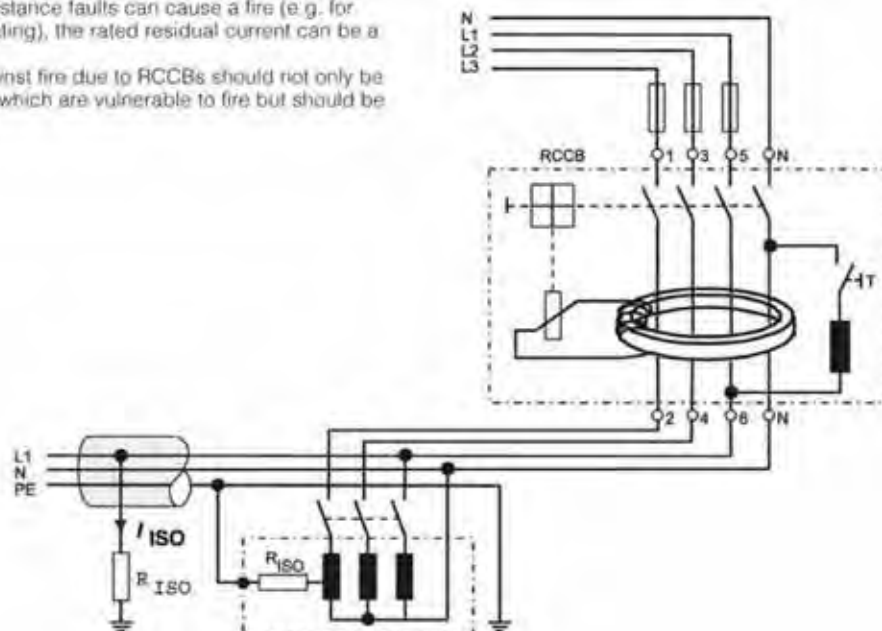

Protective devices	max. possible cont. current I_{ISO}	P_{ISO} for $U_M = \sim 230$ V
Fuse 10 A	15 A	3.450 W
MCB B/C/D 16 A	18 A	4.160 W
RCCB $I_{\Delta n} = 0.5$ A	0.5 A	115 W
RCCB $I_{\Delta n} = 0.3$ A	0.3 A	69 W
RCCB $I_{\Delta n} = 30$ mA	0.03 A	6.9 W

For a fire, min. power required: $P > 70 - 100$ W

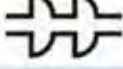

Standards	DIN EN 61008-1 / DIN VDE 0664-10
Number of poles	2-pole, 4-pole
Short circuit withstand rating	10 kA at assignment of the corresponding back-up fuse
Max. back-up fuse	Fuse according to DIN VDE 0636 operating class gL
	for 2-pole 16 to 40 A RCCBs: 63 A
	for 4-pole 25 to 80 A RCCBs: 100 A for 4-pole 125 A RCCBs: 125 A
Rated AC voltage	2-pole 125/230 V~ 50/60 Hz, 4-pole 230/400 V~ 50/60 Hz Can be used in networks: 2-pole 120/240 V~, 4-pole 240/415 V~
Rated current I_n	16 A, 25 A, 40 A, 63 A, 80 A and 125 A
Rated residual current $I_{\Delta n}$	10 mA, 30 mA, 0,3 A, 0,5 A
Ambient temperature	-25° C to +45° C
Storage temperature	-40° C to +60° C
Electrical and mechanical endurance	10.000 switching cycles (10.000 ON/10.000 OFF)
Protection cover	Finger safe and safe to back of hand acc. to DIN EN 50274, VDE 0660-514, BGV A2
Insulation group according to DIN VDE 0110	Group I CTI - 600 V
Degree of protection according to IEC 60529 / EN60259	IP 20
Installation position	any
Mounting	Din rail according to DIN EN 60715 35 mm
Climatic resistance	Humid heat cycle according to DIN IEC 60068-2-30

RCCB terminals	at I_n A	Bottom terminal box		Top terminal box	
		max.	min.	max.	min.
with 2 modules	16, 25, 40	16 mm ²	1 mm ²	16 mm ²	1 mm ²
with 4 modules	25, 40, 63, 80	25 mm ²	1,5 mm ²	25 mm ²	1,5 mm ²
with 4 modules	125	50 mm ²	2,5 mm ²	50 mm ²	2,5 mm ²
Busbar	16 to 80	up to 2 mm thickness		not possible	
Conductor and busbar	16 to 80	2-pole up to 16 mm ² 4-pole up to 25 mm ²		not possible	
Busbar	125	not possible		not possible	
Conductor and busbar	125	not possible		not possible	
Add-on auxiliary contact terminals	6	0,75 mm ² to 2,5 mm ²			

Type of current	Current form	Tripping current
AC residual current		0,5 ... 1,0 $I_{\Delta n}$
Pulsating DC residual currents pos. or neg. half-waves		0,35 ... 1,4 $I_{\Delta n}$
Startled half-wave currents Phase control angle $\frac{90^\circ \text{ et } 135^\circ \text{ et}}$		0,25 ... 1,4 $I_{\Delta n}$ 0,11 ... 1,4 $I_{\Delta n}$
Half-wave current during superposition with smooth DC of 6 mA		max: 1,4 $I_{\Delta n}$ + 6 mA
Smooth DC		0,5 ... 2,0 $I_{\Delta n}$

**RCCB 2-pole 16 to 40 A
FIP**

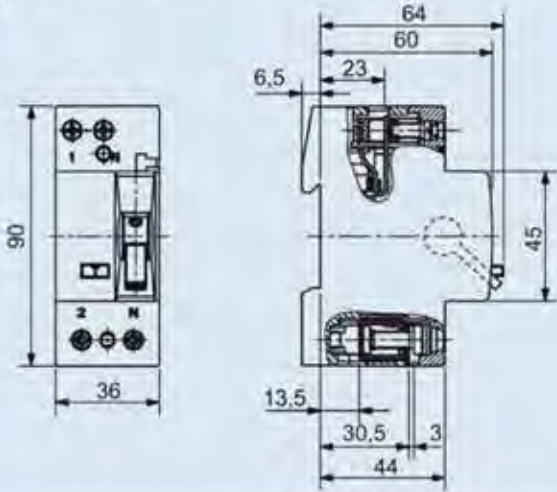

**Auxiliary contact for 2-pole and 4-pole RCCBs 16 up to 80 A,
FIH11**

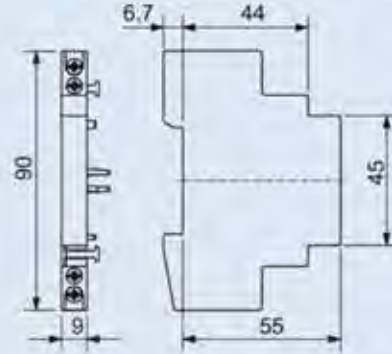

**RCCB 4-pole 25 to 80 A
FIP and FIK**

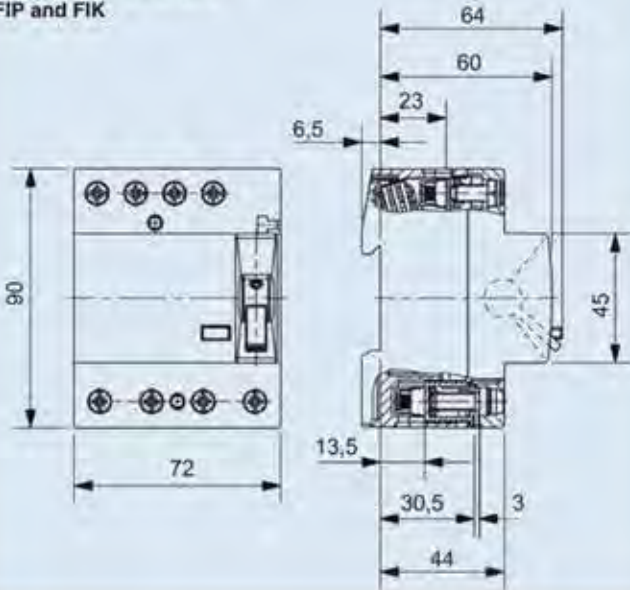

**RCCB 4-pole 25 to 80 A
FI...A and FI...S**

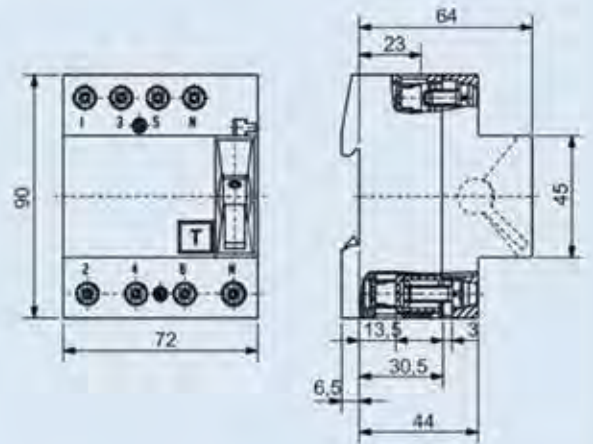

**RCCB 4-pole 125 A
FIP47 and FIS47**

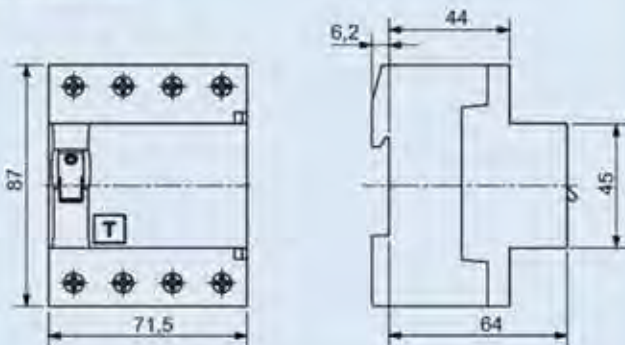

Auxiliary contact FIH125 for 4-pole RCCBs 125A

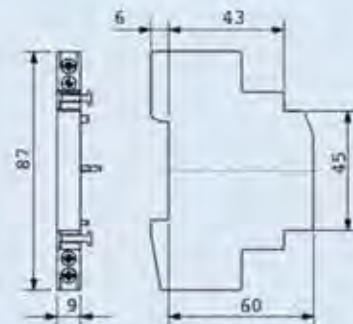

RCCBs, sensitive to pulsating currents, Typ A

Instantaneous tripping

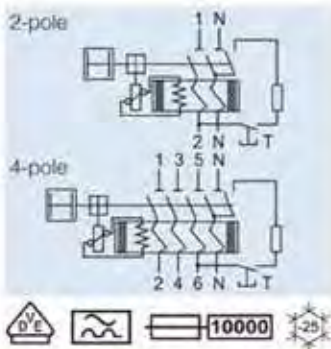

RCCBs with instantaneous trip $I_{\Delta n} \leq 30$ mA provide protection against personal injury in case of indirect and direct contact.
 RCCBs with instantaneous trip $I_{\Delta n} \leq 300$ mA offer fire protection prevention measures for earth residual currents.
 Device regulations according to IEC/EN 61008-1 (VDE 0664-10) IEC 61008-2-1 (VDE 0664-11) IEC EN 61 543 (VDE 0664-30)
 Current strength with current form 8/20 μ s according to DIN VDE 0432-2
 U_n 230/400V, 50-60 Hz; can be used in systems up to 240/440 V AC

Rated residual current $I_{\Delta n}$ mA	Rated current I_n A	Surge current strength > kA	Max. back-up fuse A	Modules	Article no.	Weight g/each	Pack. unit
--	-----------------------	-----------------------------	---------------------	---------	-------------	---------------	------------

2-pole

10	16	1	63	2	FIP2101	290	1
30	25	1	63	2	FIP2203	290	1
300	25	1	63	2	FIP2300	290	1
30	40	1	63	2	FIP2303	290	1
300	40	1	63	2	FIP2330	290	1



4-pole

30	25	1	100	4	FIP4203	450	1
300	25	1	100	4	FIP4230	450	1
500	25	1	100	4	FIP4250	450	1
30	40	1	100	4	FIP4303	450	1
300	40	1	100	4	FIP4330	450	1
500	40	1	100	4	FIP4350	450	1
30	63	1	100	4	FIP4403	450	1
300	63	1	100	4	FIP4430	450	1
500	63	1	100	4	FIP4450	450	1
30	80	1	100	4	FIP4503	450	1
300	80	1	100	4	FIP4530	450	1



4-pole

30	125	1	125	4	FIP4703	500	1
300	125	1	125	4	FIP4730	500	1
500	125	1	125	4	FIP4750	500	1



Auxiliary contact

for RCCBs up to 80 A
 Rated operating current I_e
 at AC-12 for U_e 230V AC 6 A
 at AC-14 for U_e 230V AC 3,6 A
 at DC-13 for U_e 220V UC 1 A

1/2 M

	Article no.	Weight g/each	Pack. Unit
1NO 1NC	FIH11	45	1



Auxiliary contact

for RCCB 125 A
 Rated operating current I_e
 at AC-12 for U_e 230V AC 6 A
 at DC-13 for U_e 220V UC 1 A

1/2 M

	Article no.	Weight g/each	Pack. Unit
1NO 1NC	FIH125	40	1



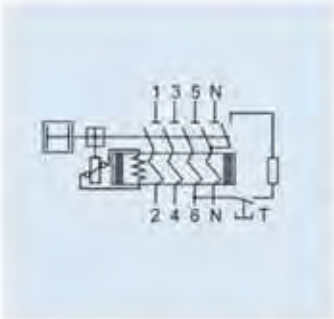

Short-time delayed tripping K

RCCBs with short-time delayed trips have a minimum tripping delay of 10 ms, i.e. they must not trip at a residual current impulse of 10 ms duration. Thus the maximum permissible trip times according to IEC/EN 61008 (VDE 0664-10) are kept.

Areas of application:

- in areas with many thunderstorms
- devices that cause high drainage currents when switched on, e.g. panel heating, large amount of fluorescent lamps, fluorescent lamps with a series connection unit, x-ray units and computers

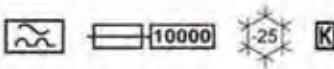

Rated residual current $I_{\Delta n}$ mA	Rated current I_n A	Surge current strength >kA	Max. back-up fuse A	Modules	Article no.	Weight g/each	Pack/ Unit
--	-----------------------------	-------------------------------	------------------------	---------	-------------	------------------	---------------



4-pole							
30	40	3	100	4	FIK4303	450	1

Selective tripping S

RCCBs with selective trip have a switch off time of 60... 110 ms and a high surge current strength of 5 kA. Can be used as upstream group RCCB for selective trip as opposed to downstream standard RCCBs.

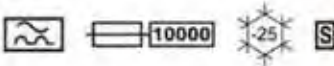

Rated residual current $I_{\Delta n}$ mA	Rated current I_n A	Surge current strength >kA	Max. back-up fuse A	Modules	Article no.	Weight g/each	Pack/ Unit
--	-----------------------------	-------------------------------	------------------------	---------	-------------	------------------	---------------



4-pole							
300	125	5	125	4	FIS4730	500	1

Short circuit selectivity to fuses in kA

RCBO 6 kA

		Rated current I_n (A)											
Characteristic	B	6	10	13	13	16	20	25	32	40			
	C	6	10	13	13	16	20	25	32	40			
Fuse according to DIN VDE 0636 operating class	I_n (A)	16											1.)
		0,4											
		0,35											
		0,7	0,5	0,45	0,45	0,4	0,4						
		0,55	0,45	0,4	0,4	0,4							
		1,1	0,75	0,7	0,7	0,6	0,6	0,7	0,6				
		0,8	0,7	0,6	0,6	0,6	0,6	0,6					
		2,0	1,4	1,3	1,3	1,2	1,2	1,3	1,2	1,3	1,2		
		1,5	1,4	1,2	1,2	1,2	1,2	1,2	1,2	1,2	1,2		
		4,1	2,4	2,0	2,0	2,0	2,0	2,0	2,0	2,0	2,0	1,8	1,8
	2,8	2,3	2,0	2,0	2,0	2,0	2,0	2,0	2,0	2,0	2,0	1,8	
	6,0	3,4	2,7	2,7	2,7	2,7	2,7	2,7	2,7	2,7	2,7	2,7	
	4,7	3,3	3,0	3,0	3,0	3,0	3,0	3,0	3,0	2,8	2,8	2,8	
	6,0	4,2	3,6	3,6	3,6	3,6	3,6	3,6	3,6	3,6	3,6	3,6	
	6,0	4,2	3,5	3,5	3,5	3,5	3,5	3,5	3,5	3,5	3,5	3,5	
	6,0	6,0	6,0	6,0	6,0	6,0	6,0	6,0	6,0	6,0	6,0	6,0	
	6,0	6,0	6,0	6,0	6,0	6,0	6,0	6,0	6,0	6,0	6,0	6,0	

1.) There is no more overload selectivity above the step line.

Short circuit selectivity to fuses in kA

RCBO 10 kA

		Rated current I_n (A)				
Characteristic	B	10	13	16	16	
	C	10	13	16	16	
Fuse according to DIN VDE 0636 operating class	I_n (A)	16				1.)
		0,55	0,5	0,5	0,5	0,5
		0,5	0,5	0,5	0,5	0,5
		0,8	0,75	0,75	0,7	0,7
		0,8	0,7	0,7	0,7	0,7
		1,5	1,4	1,4	1,3	1,3
		1,5	1,3	1,3	1,3	1,3
		2,8	2,3	2,3	2,3	2,3
		2,7	2,3	2,3	2,3	2,3
		4,6	3,9	3,9	3,9	4,0
	5,0	4,0	4,0	4,0	4,0	
	7,0	6,0	6,0	6,0	6,0	
	7,0	5,0	5,0	5,0	5,0	
	10,0	10,0	10,0	10,0	10,0	
	10,0	10,0	10,0	10,0	10,0	

1.) There is no more overload selectivity above the step line.

RCCBs, sensitive to universal current, Typ B

Description

Function

This device type works according to VDE 0664-100, valid in Germany in the detection, evaluation and trip for the requirements for type A, independent of mains voltage. A voltage supply is only necessary for physical reasons for the detection of smooth DC residual currents. This results from all power lines. The function is available from a minimum voltage of 50 V. Therefore a maximum of safety is provided also for the voltage-dependent component of the device function. Even in the case that there is a voltage only on one conductor and thus a fault current flows, the protection is supplied by the mains voltage independent tripping function of the voltage-independent pulsating-current-sensitive device part.

According to the product standard VDE 0664-1 00, RCCBs of type B are designed to be used in three-phase systems with 50/60 Hz and not in the DC voltage network. With electronic equipment, like e.g. on the outgoing side of a frequency converter, AC residual currents of different frequencies can arise as well as the fault current forms described.

Extended tripping conditions are therefore defined for RCCBs of type B for frequencies up to 2 kHz. The tripping characteristics of the RCCBs of type B with rated residual currents of 30 mA and 300 mA are shown in the figure below.

The tripping value of the universal-current-sensitive RCCB of type B always lies within the limit values of the device regulations and, for the rated residual current of 30 mA, also well below the limit curve for dangerous cardiac fibrillation (according to IEC 60479-2).

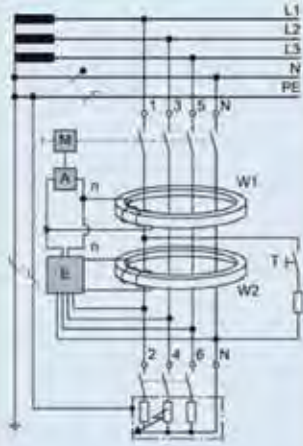

- A = tripping unit
- M = mechanical components of the protection equipment
- E = electronics for release for smooth DC residual currents
- T = test equipment
- n = secondary winding
- W1 = summation current transformer for detecting of the sinusoidal residual currents
- W2 = summation current transformer for detecting of the smooth DC residual currents

Tripping current depending on the frequency

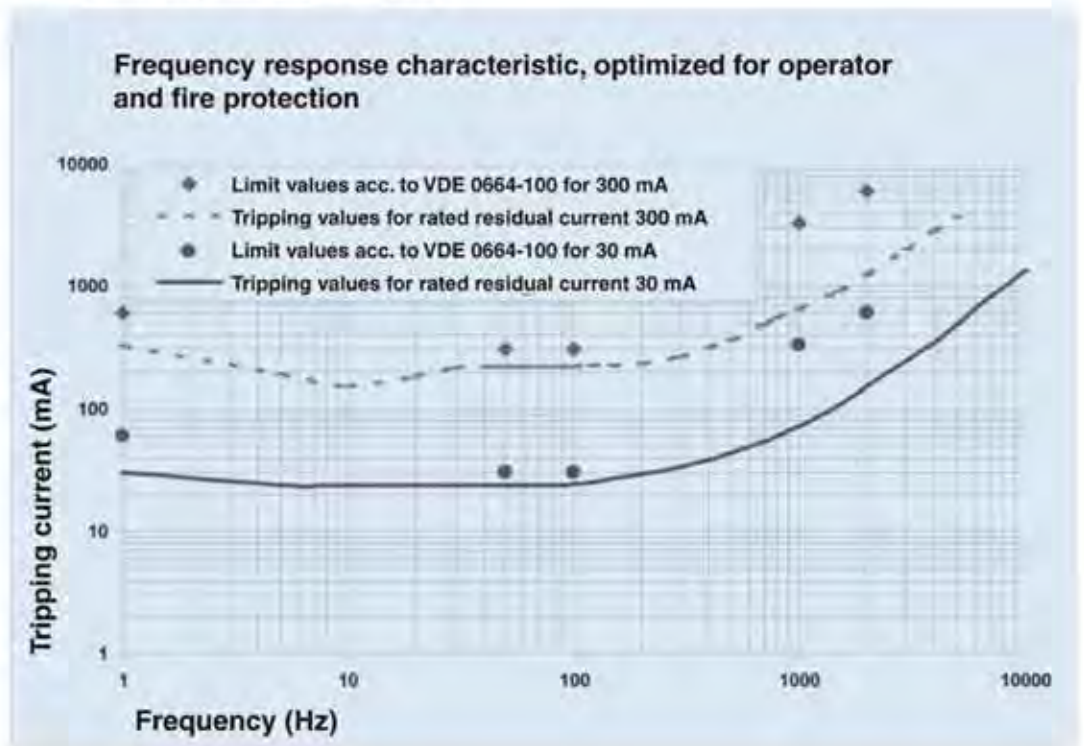

Typ AC are suitable for detecting sinusoidal AC residual currents. For input circuits 1 to 3.
Typ A also detect pulsating DC residual currents as well as sinusoidal AC residual currents. For input circuits 1 to 6.
Typ B are used, not only for detecting residual currents of type A, but also for detecting smooth DC residual currents. These RCCBs are suitable for use in the input circuits 1 to 10.

Fault current forms:

B	A	AC	circuit	load current	residual current
<input type="checkbox"/>	<input type="checkbox"/>	<input type="checkbox"/>	1 		
<input type="checkbox"/>	<input type="checkbox"/>	<input type="checkbox"/>	2 		
<input type="checkbox"/>	<input type="checkbox"/>	<input type="checkbox"/>	3 		
<input type="checkbox"/>	<input type="checkbox"/>	<input type="checkbox"/>	4 		
<input type="checkbox"/>	<input type="checkbox"/>	<input type="checkbox"/>	5 		
<input type="checkbox"/>	<input type="checkbox"/>	<input type="checkbox"/>	6 		
<input type="checkbox"/>	<input type="checkbox"/>	<input type="checkbox"/>	7 		
<input type="checkbox"/>	<input type="checkbox"/>	<input type="checkbox"/>	8 		
<input type="checkbox"/>	<input type="checkbox"/>	<input type="checkbox"/>	9 		
<input type="checkbox"/>	<input type="checkbox"/>	<input type="checkbox"/>	10 		

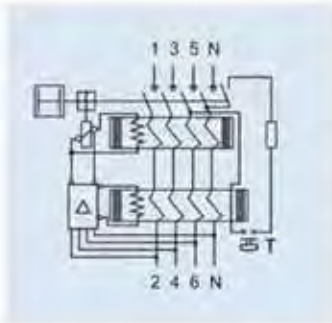

RCCBs of type B, as well as detecting residual current shapes of type A, are also used for detecting smooth DC residual currents and for input circuits 7 to 10 according to table "Technical Data - fault current forms" (see left page).

Areas of application

- Frequency converters, lift control systems, ventilator control systems
- Medical devices like x-ray devices, CT systems
- Photovoltaic systems, UPS systems
- Construction sites according to BGI 608 (electrical equipment on construction sites)
- Variable-speed machine tools
- All types of cranes

Short-time delayed tripping **K**

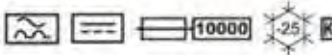

Nominal residual current $I_{\Delta n}$ mA	Nominal current I_n A	Surge current strength > kA	Max. back-up fuse A	Modules	Article no.	Weight g/each	Pack. Unit
--	-------------------------------	--------------------------------	------------------------	---------	-------------	------------------	---------------



4-pole							
30	25	1	100	4	FI4203A	450	1
300	25	1	100	4	FI4230A	450	1
30	40	1	100	4	FI4303A	450	1
300	40	1	100	4	FI4330A	450	1
30	63	1	100	4	FI4403A	450	1
300	63	1	100	4	FI4430A	450	1
500	63	1	100	4	FI4450A	450	1
30	80	1	100	4	FI4503A	450	1
300	80	1	100	4	FI4530A	450	1

Selective tripping **S**



Rated residual current $I_{\Delta n}$ mA	Rated current I_n A	Surge current strength > kA	Max. back-up fuse A	Modules	Article no.	Weight g/each	Pack. Unit
--	-----------------------------	--------------------------------	------------------------	---------	-------------	------------------	---------------



4-pole							
300	63	3	100	4	FI4430S	450	1

Rated voltage U_n	AC 230 V, suitable for networks up to 250 V
Rated residual current $I_{\Delta n}$ 10 mA	10 mA, 30 mA and 300 mA
Function limit for functions of the test equipment	AC 100 V
Short circuit withstand rating I_{cn} (according to DIN EN 61009)	6 kA and 10 kA
Energy limiting class	3
Frequencies	50 Hz to 60 Hz
Insulation coordination	Overvoltage category III, for degree of pollution according to DIN VDE 0110
EMC	According to DIN EN 61009 and DIN EN 61543
Installation devices	CB 1-pole+N(2 modules), CB-2-pole (3 modules)
Installation position	any
Degree of protection	IP 20 according to DIN 40 050
Connecting terminals	Both-sided multi-function terminal For simultaneous connection of conductors and pin rails
Terminal screws	\pm and Pozidriv 2
Torque	2.5 to 3 Nm
Conductor cross sections	Single and multi-wire conductor: 0,75 to 35 mm ² Stranded wire with ferrule: 0,75 to 25 mm ²

Thermal trip and short circuit trip circuit breaker

Characteristic	B	C
Thermal not tripping I_1 (A) > 1 h	$1,13 \times I_n$	$1,13 \times I_n$
Thermal tripping I_2 (A) < 1 h	$1,45 \times I_n$	$1,45 \times I_n$
Electromagnetic not tripping I_3 (A) > 0,1 s	$3 \times I_n$	$5 \times I_n$
Electromagnetic tripping I_5 (A) < 0,1 s	$5 \times I_n$	$10 \times I_n$

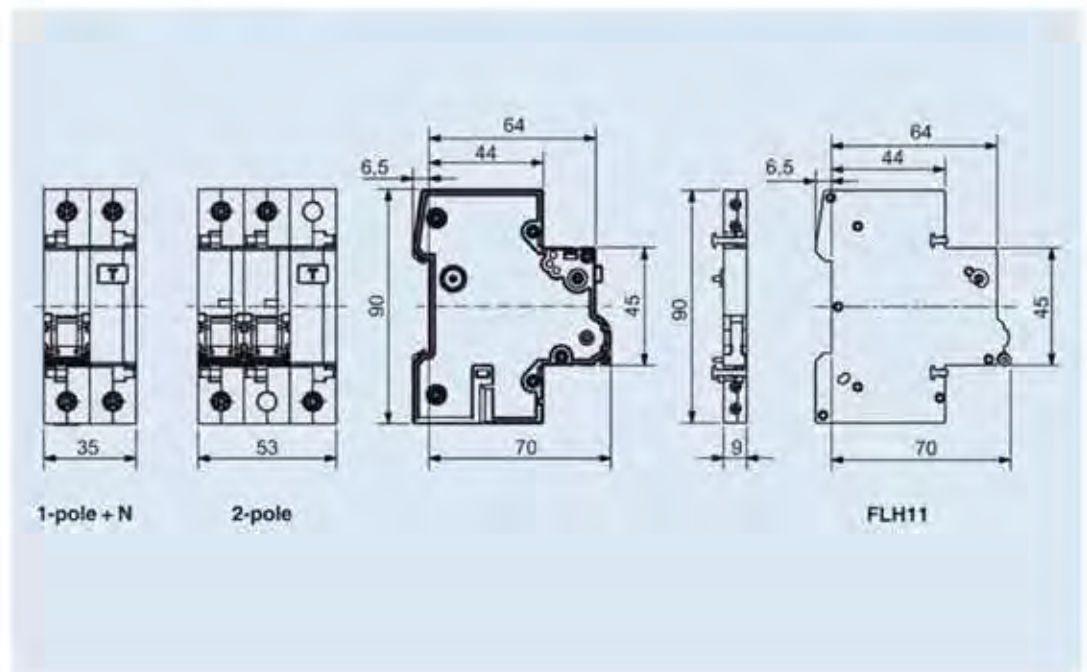

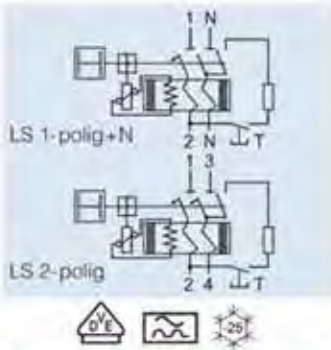

RCBOs offer a compact possibility of implementing wiring protection and protection against personal injury in one device. The RCBO protects itself through its CB part against overload. An undesired overload due to too-high load currents is not possible. One RCBO is assigned to every circuit. So the full fault current is available to every circuit as drainage current. For one fault current in a circuit, only the affected circuit is switched off.

Rated current I_n A	Rated residual current $I_{\Delta n}$ mA	Characteristic		Modules	Weight g/each	Pack. Unit
		B Article no.	C Article no.			

Short circuit withstand rating 6 kA 6000
MCB 1-pole + N 9

6	30	-	FC0603	2	260	1
10	30	FB1003	FC1003	2	260	1
13	30	FB1303	-	2	260	1
16	30	FB1603	FC1603	2	260	1
16	300	FB1630	FC1630	2	260	1
20	30	-	FC2003	2	260	1
25	30	-	FC2503	2	260	1
32	30	-	FC3203	2	260	1
40	30	-	FC4003	2	260	1

Short circuit withstand rating 10 kA 10000
MCB 1-pole + N 9

16	10	FB1601	FC1601	2	270	1
----	----	--------	--------	---	-----	---

Short circuit withstand rating 10 kA
MCB 2-pole

10	30	FB1003N		3	400	1
13	30	FB1303N		3	400	1
16	30	FB1603N	FC1603N	3	400	1

Auxiliary contact

Rated operating current I_o
at AC-14 for U_e 400V AC 2 A
at AC-14 for U_e 230V AC 6 A
at DC-13 for U_e 110/220V UC 1 A
at DC-13 for U_e 24V UC 6 A
1/2 M

	Article no.	Weight g/each	Pack. Unit
1NO/ 1NC	FLH11	45	1



Busbar 2-pole

Pin type
for RCBOs 2 M
Single phase + N
Cross section 16 mm²
Busbar current 80/130 A

	Article no.	Weight g/each	Pack. Unit
56 M	SB25516	430	20