



ABL  SURSUM



Motor Protective Circuit Breakers

JD Auspice Co.,Ltd.

TEL : 886-2-8991-2796

FAX : 886-2-8991-9298

service@jdauspice.com

<http://www.jdauspice.com>



Innovative products from the town of Lauf

With its product variety of over 5,000 articles, the well-established German company ABL SURSUM supplies the markets throughout the whole world.



Customer benefit from know-how and experience

The constant high quality of our products is the result of our comprehensive technical know-how and long-standing experience. Product development, in-house tool/equipment manufacturing as well as component manufacturing in plastic and metal engineering, and final assembly: all steps of the value chain are performed at ABL SURSUM. This is what gives us the edge in technical know-how and marketability for the benefit of our customers.

**Development:
Everything on our premises**

Every new product starts with an idea. However, putting ideas into practice requires a lot of experience and the right equipment. This is why the experienced product developers here at ABL SURSUM use only the most modern CAD software while constantly being in touch with customers – because only exact product and market knowledge will result in innovative products suited to requirements.

**Tool and equipment manufacturing:
Quality as the key criterion**

The quality of a manufacturing process starts with the right production facilities. This is why ABL SURSUM builds and maintains their plastic and metal tools in their own facilities. Likewise, a large part of the machines and appliances is built at ABL SURSUM. Because when you plan and build equipment yourself, you are capable of optimum maintenance, continuous further development, and of adapting it to new demands.

**Component manufacturing:
In-house production is better**

Even the smallest component is part of the final product's quality. Therefore, ABL SURSUM produces most of the components for their products on their own premises. In this way, we ensure a seamless and high-quality supply of components for a smooth manufacturing process.

**Final assembly:
Know-how and technology combined**

Experienced, skilled employees and a high degree of automation guarantee on-time production while maintaining a high quality level. Because only high-quality products can compete in the long term.





**Quality assurance:
No compromises**

Quality is one of the most central aspects of ABL SURSUM's success story. It is a key element of our philosophy which we adhere to even in times of price-driven marketing strategies. Because long-term success is always related to customer satisfaction and thus to quality and reliability, ABL SURSUM has been DIN ISO 9001 certified for many years, of course.

Permanent quality monitoring using state-of-the-art testing methods is taken for granted at ABL SURSUM. Therefore we accept no compromises in ongoing manufacturing and final inspection. Naturally, our products have all the relevant national and international test seals.



**Logistics:
Service starts at the delivery stage**

In times of ever tighter deadlines, a well-organised sales network, a well-equipped warehouse and modern logistics guarantee on-time delivery both nationally and internationally. Boasting a 50% export percentage, ABL SURSUM supplies numerous customers all over the world punctually every day.



Technical Data	Page	7
Motor Protective Circuit Breakers MS - with overload and short circuit tripping	Page	11
Motor Protective Circuit Breakers BS - with overload tripping	Page	11
Transformer Protective Circuit Breakers MST - with overload and short circuit tripping	Page	12
Motor Protective Circuit Breakers MSH (for AC motors) - with auxiliary contact, overload and short circuit tripping	Page	13
Motor Protective Circuit Breakers MSW (for AC motors) - with overload and short circuit tripping	Page	13
Motor Protective Devices for variable-speed fan motors	Page	14
Accessories	Page	15
Motor Protective Circuit Breakers MA	Page	21
Accessories	Page	27
Manual Motor Controller MA according to UL 508 and CSA - 22.2 No.14	Page	30
Accessories	Page	30



Motor Protective Circuit Breakers



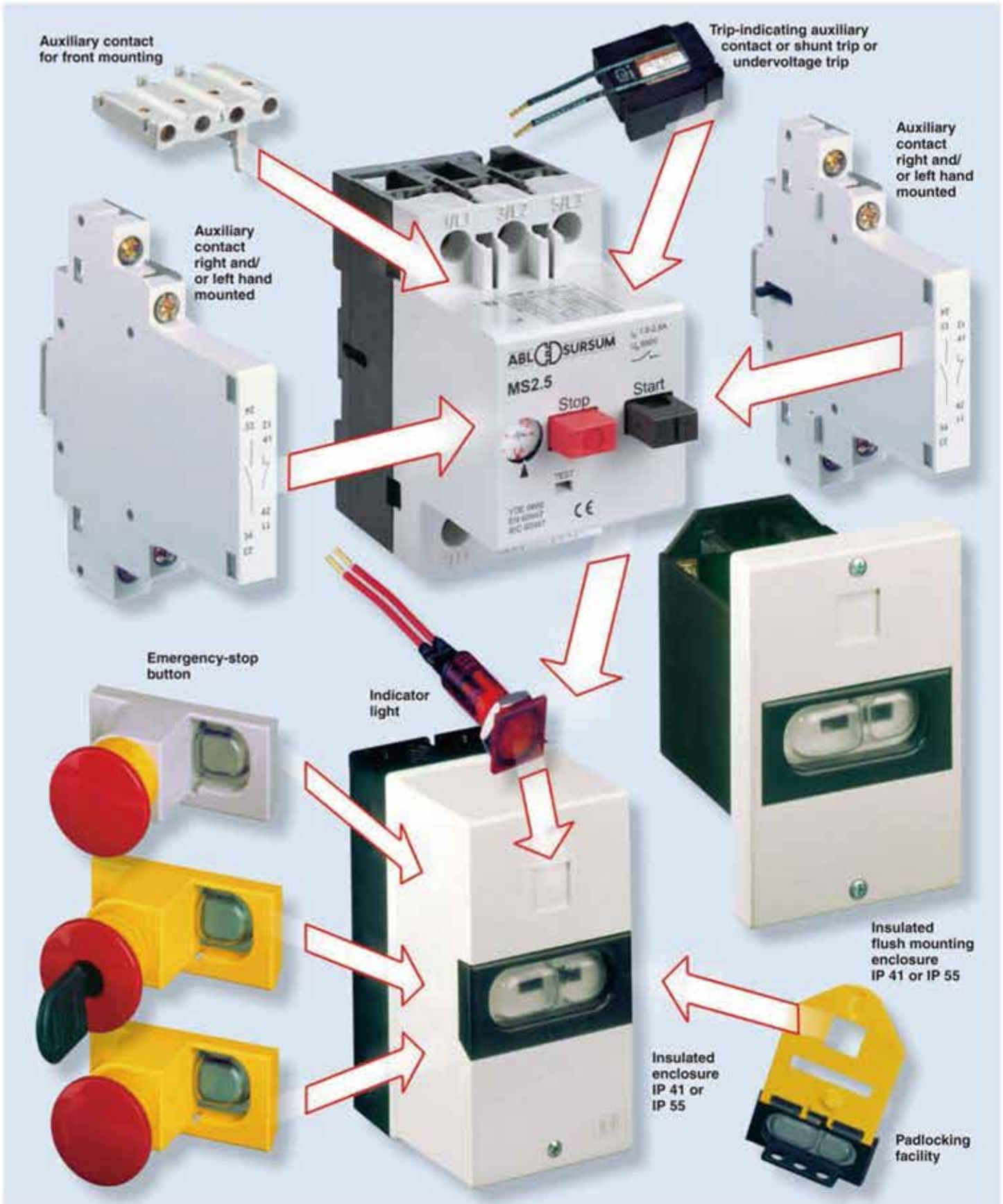

Technical Data

Standards	IEC 60947, DIN EN 60947, VDE 0660
Mechanical endurance - Electrical endurance	0,1 x 10 ⁶ switching cycles
Max. operating frequency	30 switching cycles / h
Ambient temperature not enclosed, max./min. enclosed, max./min	+55° C / -20° C +40° C / -20° C
Resistance to mechanical shocks	15 g / 10 ms
Installation position	any, in IP 41 enclosure vertical
Cross section (1 or 2 conductors)	1,0 – 6 r; 0,75 – 4 l (with ferrule) 2 conductors differing by not more than 2 sizes
Torque for terminal screws - Main conductor - Auxiliary conductor - Auxiliary contact for front mounting	1,2 Nm 1,0 Nm 0,5 Nm
Rated impulse withstand voltage U _{imp}	6000 V
Overvoltage category / Pollution level	III / 3
Rated operating voltage U _e	690 V AC
Rated operating current I _e	0,16 – 32 A according to setting range
Frequency	40...60 Hz
	At higher frequencies, the electromagnetic tripping values rise by a factor of about 1,1 at 100 Hz; 1,2 at 200 Hz; 1,4 at 400 Hz; 1,5 at 500 Hz
Utilization category (IEC 60947-4-1, DIN EN 60947-4-1, VDE 0660-102)	AC-3 max. 690 V
Temperature compensation (reference values to VDE / IEC)	-5° C / +40° C
Temperature compensation Operating range	-30° C...+55° C
Power loss in watt per path of current	by min. setting range 0,6 – 1,05 W / by max. setting range 1,5 – 2,6 W

Rated short circuit withstand rating I_{cu} MS IEC 60947-2, DIN EN 60947-2, VDE 0660-101

Upper setting Thermal tripping	I _{cu} (kA)				Current limiter SBMS32 I _{cu} (kA)	
	230 V	400 V	500 V	690 V	230 V	400 V
0,16 – 1,6 A	No additional protective devices needed inherently stable for any selected short circuit currents				No additional protective devices needed inherently stable for any selected short circuit currents	
2,5 – 6,3 A			3	2,5		
10 A		6	3	2,5		50
16 – 32 A	10	6	2,5	2	100	50

Switching times at short circuit
 minimum command time: 2 ms
 opening delay: 2 ms
 opening time: 7 ms.

Back-up-protection MS (if the short circuit current is higher than the short circuit withstand rating of MS)

Rated current	Back-up fuse (gL, aM) (A)			
	230 V	400 V	500 V	690 V
0,1 - 0,16 A				
0,16 - 0,25 A	No back-up fuse necessary			
0,25 - 0,4 A	inherently stable for any			
0,4 - 0,63 A	selected short circuit currents			
0,63 - 1 A				
1 - 1,6 A				
1,6 - 2,5 A			25	20
2,5 - 4 A			35	25
4 - 6,3 A			50	35
6,3 - 10 A		80	50	35
10 - 16 A	80	80	63	35
16 - 20 A	80	80	63	50
20 - 25 A	80	80	63	50
25 - 32 A	80	80	63	50

Back-up-protection BS

Rated current (A)	Fuse (A)	Rated current (A)	Fuse (A)	Rated current (A)	Fuse (A)
0,4 - 0,63	2	2,5 - 4	10	16 - 20	50
0,63 - 1	4	4 - 6,3	16	20 - 25	50
1 - 1,6	6	6,3 - 10	25	25 - 32	50
1,6 - 2,5	6	10 - 16	35		

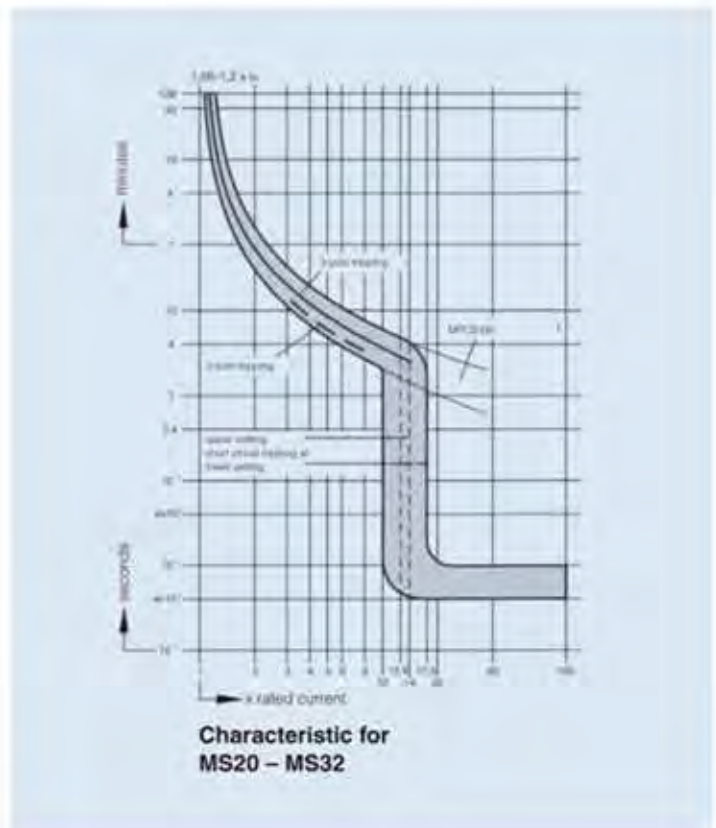
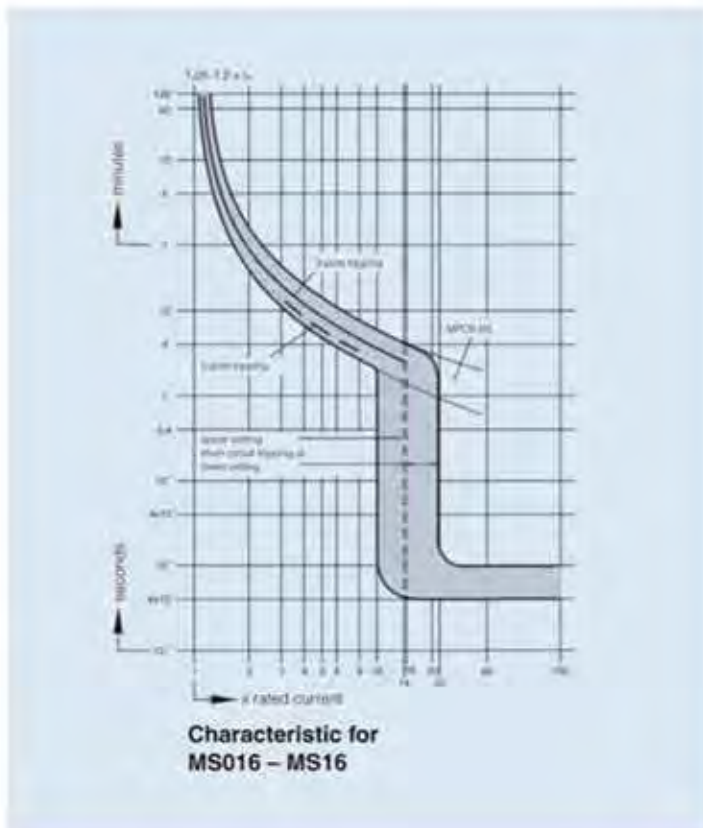

Motor protective circuit breaker MS

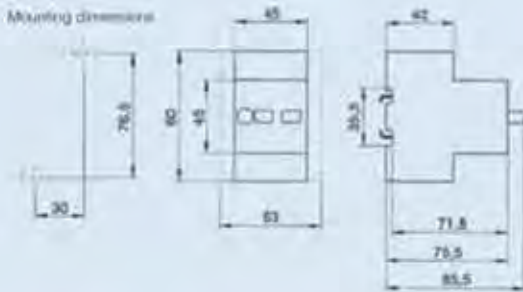

Current limiter SBMS32

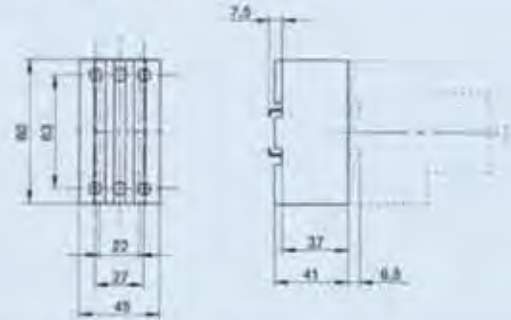

Insulated enclosure IP41 / IP55 MS.G41 / MS.G55

possible to integrate 1 MPCB and 2 side mounted auxiliary contacts

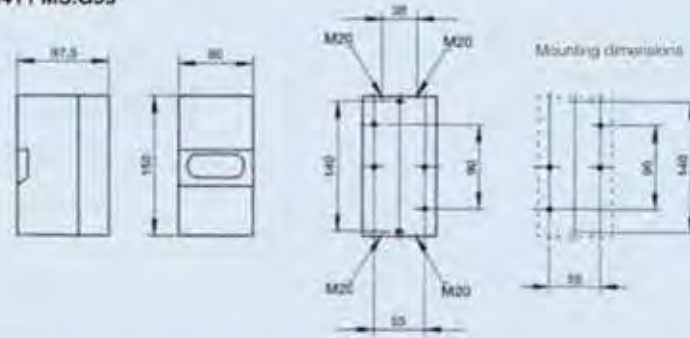

Insulated flush mounting enclosure MS.F41 / MS.F55

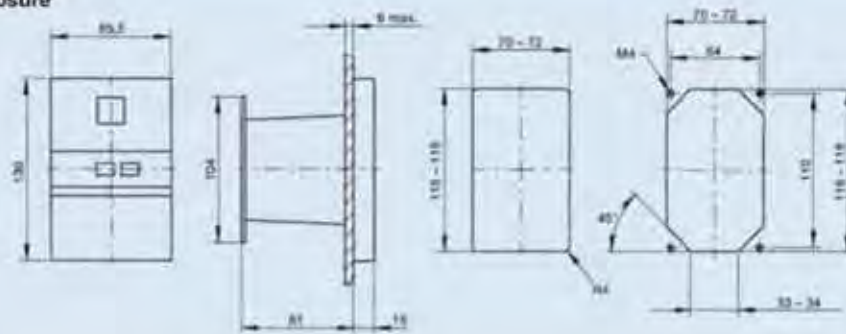

Insulated enclosure with CEE plug

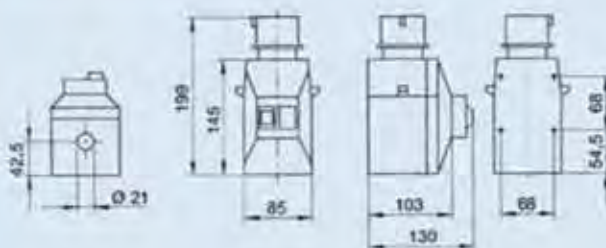

Emergency-stop button MS.PT – PS.PS2

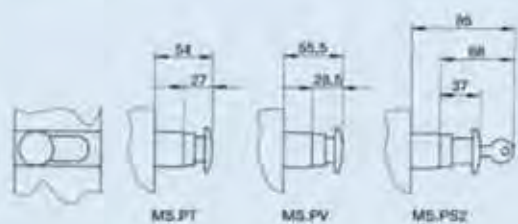

Nominal Rated Motor Currents

Nominal rated motor currents for three-phase motors (reference values for cage rotors)
 Lowest possible short circuit fuse for three-phase motors. The maximum value is calculated according to setting range.

Motor power			230 V			400 V			500 V			690 V		
kW	cos. φ	%	Nominal rated motor current	Fuse		Nominal rated motor current	Fuse		Nominal rated motor current	Fuse		Nominal rated motor current	Fuse	
			A	Start-up direct	Y/Δ	A	Start-up direct	Y/Δ	A	Start-up direct	Y/Δ	A	Start-up direct	Y/Δ
0,06	0,7	58	0,37	2	-	0,21	2	-	0,17	2	-	0,12	2	-
0,09	0,7	60	0,54	2	-	0,31	2	-	0,25	2	-	0,18	2	-
0,12	0,7	60	0,72	4	2	0,41	2	-	0,33	2	-	0,24	2	-
0,18	0,7	62	1,04	4	2	0,6	2	-	0,48	2	-	0,35	2	-
0,25	0,7	62	1,4	4	2	0,8	4	2	0,7	2	-	0,43	2	-
0,37	0,72	62	2	6	4	1,2	4	2	0,9	2	2	0,7	2	-
0,55	0,75	69	2,7	10	4	1,5	4	2	1,2	4	2	0,9	4	2
0,75	0,78	74	3,2	10	4	1,9	6	4	1,5	4	2	1,1	4	2
1,1	0,81	74	4,6	10	6	2,6	6	4	2,1	6	4	1,5	4	2
1,5	0,81	74	6,3	16	10	3,6	6	4	2,9	6	4	2,1	6	4
2,2	0,81	78	8,7	20	10	5	10	6	4	10	4	2,9	10	4
3	0,82	80	11,5	25	16	6,6	16	10	5,3	16	6	3,8	10	4
4	0,82	83	14,8	32	16	8,5	20	10	6,8	16	10	4,9	16	6
5,5	0,82	86	19,6	32	25	11,3	25	16	9	20	16	6,5	16	10
7,5	0,82	87	26,4	50	32	15,2	32	16	12,1	25	16	8,8	20	10
11	0,84	87	38	80	40	21,7	40	25	17,4	32	20	12,6	25	16
15	0,84	88	51	100	63	29,3	63	32	23,4	50	25	17	32	20
18,5	0,84	88	63	125	80	36	63	40	28,9	50	32	20,9	32	25
22	0,84	92	71	125	80	41	80	50	33	63	32	23,8	50	25
30	0,85	92	96	200	100	55	100	63	44	80	50	32	63	32
37	0,86	92	117	200	125	68	125	80	54	100	63	39	80	50
45	0,86	93	141	250	160	81	160	100	65	125	80	47	80	63
55	0,86	93	173	250	200	99	200	125	79	160	80	58	100	63
75	0,86	94	233	315	250	134	200	160	107	200	125	78	160	100
90	0,86	94	279	400	315	161	250	200	129	200	160	93	160	100
110	0,86	94	342	500	400	196	315	200	157	250	160	114	200	125
132	0,87	95	401	630	500	231	400	250	184	250	200	134	250	160
160	0,87	95	486	630	630	279	400	315	224	315	250	162	250	200
200	0,87	95	607	800	630	349	500	400	279	400	315	202	315	250
250	0,87	95	-	-	-	437	630	500	349	500	400	253	400	315
315	0,87	96	-	-	-	544	800	630	436	630	500	316	500	400
400	0,88	96	-	-	-	683	1000	800	547	800	630	396	630	400
450	0,88	96	-	-	-	769	1000	800	615	800	630	446	630	630
500	0,88	97	-	-	-	-	-	-	-	-	-	491	630	630
560	0,88	97	-	-	-	-	-	-	-	-	-	550	800	630
630	0,88	97	-	-	-	-	-	-	-	-	-	618	800	630

The nominal rated motor currents are valid for normal three-phase motors with surface and internal surface cooling with 1500 min⁻¹.

Start-up direct: Start-up current max. 6 x nominal rated motor current
 Start-up time max. 5 s.
 Y/Δ Start-up: Start-up current max. 2 x nominal rated motor current
 Start-up time max. 15 s.
 Set motor circuit breaker relays in a line to 0.58 x protective nominal rated motor current.

Nominal rated fuse currents for Y/Δ starts are also valid for three-phase motors with slip ring rotors.
 Use larger fuses for a higher rated current, start-up current and/or a longer start-up time.
 The table is valid for "delayed-action" or "gl" fuses (DIN VDE 0636)

For NH-fuses with aM characteristic, fuse = nominal rated current is selected.

The MS motor protective circuit breakers offer optimal protection for motors and other loads up to 32 A, due to its high breaking capacity with strongly limited current.

They are equipped with phase failure sensitivity, isolating and main switch functions; 14 ranges are covering nominal rated currents from 0,1 up to 32 A. The MPCBs are self protected up to 6,3 A at 400 V. Ranges > 6,3 A provide a short circuit withstand rating of 6 kA. The MPCBs are temperature compensated: the actuating current of the short circuit trip is $12 \times I_n$.

The MS motor protective circuit breakers are VDE-tested and UL-approved.

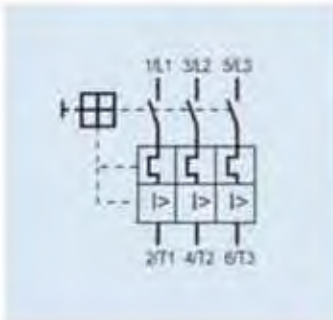

Rated current A	Max. rated operating power (kW/AC 3)			Operating current short circuit trip (A)	Article no.	Weight g/each	Pack- unit
	400/415 V	500 V	690 V				

MS with overload and short circuit tripping Phase failure sensitivity

0,1 – 0,16	–	–	0,06	1,92	MS016	250	1
0,16 – 0,25	0,06	0,06	0,12	3	MS025	250	1
0,25 – 0,4	0,09	0,12	0,16	4,8	MS04	250	1
0,4 – 0,63	0,12	0,16	0,25	7,6	MS063	250	1
0,63 – 1	0,25	0,37	0,55	12	MS1	250	1
1 – 1,6	0,55	0,75	1,1	19,2	MS1,6	250	1
1,6 – 2,5	0,75	1,1	1,5	30	MS2,5	250	1
2,5 – 4	1,5	2,2	3	48	MS4	250	1
4 – 6,3	2,2	3	4	75,6	MS6,3	250	1
6,3 – 10	4	5,5	7,5	120	MS10	250	1
10 – 16	7,5	9	12,5	192	MS16	250	1
16 – 20	9	12,5	15	240	MS20	250	1
20 – 25	12,5	15	22	300	MS25	250	1
25 – 32	15	18,5	–	384	MS32	250	1

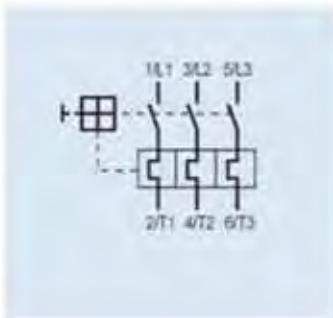

BS with overload tripping only Phase failure sensitivity

0,4 – 0,63	0,12	0,16	0,25		BS063	230	1
0,63 – 1	0,25	0,37	0,55		BS1	230	1
1 – 1,6	0,55	0,75	1,1		BS1,6	230	1
1,6 – 2,5	0,75	1,1	1,5		BS2,5	230	1
2,5 – 4	1,5	2,2	3		BS4	230	1
4 – 6,3	2,2	3	4		BS6,3	230	1
6,3 – 10	4	5,5	7,5		BS10	230	1
10 – 16	7,5	9	12,5		BS16	230	1
16 – 20	9	12,5	15		BS20	230	1
20 – 25	12,5	15	22		BS25	230	1
25 – 32	15	18,5	–		BS32	230	1

Rated current A	Max. rated operating power (kW/AC 3)			Operating current short circuit trip (A)	Article no.	Weight g/each	Pack. unit
	400/415 V	500 V	690 V				



MST with overload and short circuit tripping for transformers with high inrush currents

0,1 – 0,16	–	–	–	3,2	MST016	250	1
0,16 – 0,25	–	0,16	–	5	MST025	250	1
0,25 – 0,4	0,16	0,25	0,25	8	MST04	250	1
0,4 – 0,63	0,25	0,4	0,4	12,6	MST063	250	1
0,63 – 1	0,4	0,63	1	20	MST1	250	1
1 – 1,6	0,63	1	–	32	MST1.6	250	1
1,6 – 2,5	1	1,6	2	50	MST2.5	250	1
2,5 – 4	1,6/1	2,5	2,5	60	MST4	250	1
4 – 6,3	2,5	4	6,3	126	MST6.3	250	1
6,3 – 10	4,0/5,0	6,3	–	200	MST10	250	1
10 – 16	6,3/8	10	10	320	MST16	250	1
16 – 20	12,5	16	–	400	MST20	250	1
20 – 25	12,5	16	–	500	MST25	250	1

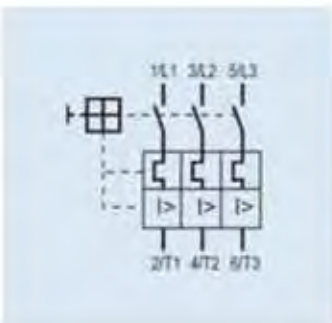

Rated current A	Max. rated operating power				Operating current short circuit trip (A)	Article no.	Weight g/each	Pack unit
	C _B 230 V 1500 1/min	C _B 230 V 3000 1/min	C _A + C _B 230 V 1500 1/min	C _A + C _B 230 V 3000 1/min				



MSH with integrated auxiliary contact 1NO for AC motors with overload and short circuit tripping

0,63 – 1	0,07	0,09	–	–	12	MSH1	220	1
1 – 1,6	0,12	0,12/0,18	0,12	0,18	19,2	MSH1.6	220	1
1,6 – 2,5	0,18	0,3	0,18/0,87	0,25	30	MSH2.5	220	1
2,5 – 4	0,22	0,5/0,55	0,37/0,5	0,37/0,66	48	MSH4	220	1
4 – 6,3	0,55/0,75	0,55/0,75	0,65	0,75/1,0	75,6	MSH6.3	220	1
6,3 – 10	1,0/1,3	1,1/1,3	1,0/1,3	1,0/1,3	120	MSH10	220	1
10 – 16	1,5 – 2,2	1,75	1,5	1,75	192	MSH16	220	1
16 – 20	–	–	–	–	240	MSH20	220	1

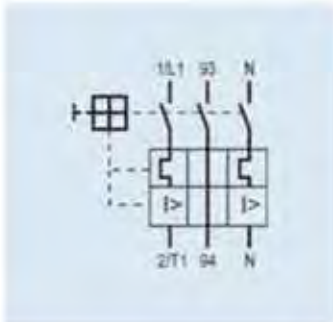

C_B with operating capacitor
C_A with starting capacitor and C_B with operating capacitor



MSW for AC motors with overload and short circuit tripping

0,63 – 1	0,07	0,09	–	–	12	MSW1	210	1
1 – 1,6	0,12	0,12/0,18	0,12	0,18	19,2	MSW1.6	210	1
1,6 – 2,5	0,18	0,3	0,18/0,87	0,25	30	MSW2.5	210	1
2,5 – 4	0,22	0,5/0,55	0,37/0,5	0,37/0,66	48	MSW4	210	1
4 – 6,3	0,55/0,75	0,55/0,75	0,65	0,75/1,0	75,6	MSW6.3	210	1
6,3 – 10	1,0/1,3	1,1/1,3	1,0/1,3	1,0/1,3	120	MSW10	210	1
10 – 16	1,5 – 2,2	1,75	1,5	1,75	192	MSW16	210	1
16 – 20	–	–	–	–	240	MSW20	210	1

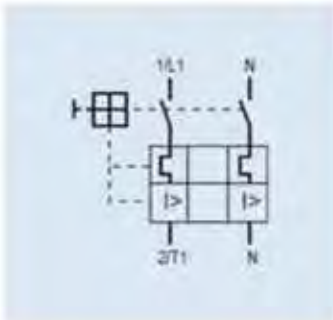

C_B with operating capacitor
C_A with starting capacitor and C_B with operating capacitor

Current operating range (A)	Article no.	Weight g/each	Pack unit
-----------------------------	-------------	---------------	-----------



Motor protection for variable-speed fan motors

0,4-10	MWC10	190	1
--------	--------------	-----	---

The MWC 10 is a multi-polar circuit breaker which allows a thermal contact, which is built into the motor (directly into the coil), to be analysed.

For example, if the motor is hindered due to dirt, the coil will heat up more than normal and the thermal contact (NC contact) in the coil will break the circuit.

The bimetal built into the circuit breaker recognizes the opening of the thermal contact in the motor coil and, with the smallest motor rated current, switches off all poles completely within max. 40 s.

However, this type of full motor protection neglects wiring protection. The connection from the full motor protection to the fan is not protected. In order to protect this connection, a back-up fuse is needed which fits the conductor cross section. This back-up fuse is usually installed in front of the full motor protection.

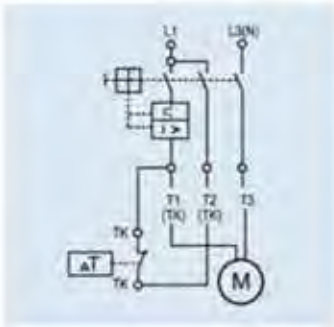

Motor protection for variable-speed fan motors including wiring protection

1,6 - 2,5	MSWC2.5	220	1
2,5 - 4,0	MSWC4	220	1
4,0 - 6,3	MSWC6.3	220	1

These 3 devices combine the function of the MWC 10 (evaluation unit for the thermal contact) with a motor protective circuit breaker for AC use (phase - neutral).

The trips for the thermal and electromagnetic tripping of the motor protective circuit breakers are in the first and third conducting paths. The evaluating bimetal for the thermal contact is in the middle conducting path of the circuit breaker.

This combined device provides optimal protection for loads by combining the normal protection of the motor protective circuit breaker with analysis by the thermal contact. This combination of motor protective circuit breaker with full motor protection **inherently stabilizes** the motor up to rated currents of 6.3 A at a mains voltage of up to 230 V AC. This means that **no additional back-up fuse** is needed.

A full motor protection for motor protective circuit breakers in connection with variable-speed fan motors is only possible by monitoring the coil temperature by means of thermal contacts installed in the motor. Therefore, the manufacturers of fan motors recommend using full motor protective devices of type MWC10 or MSWC...

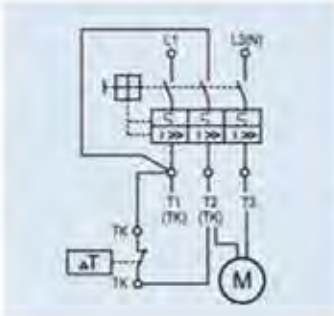

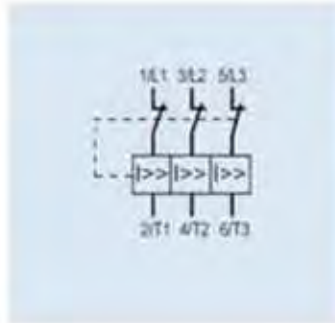

Rated uninterrupted current (A)	Article no.	Weight g/each	Pack. unit
32	SBMS32	175	1

Current limiter increasing the short circuit withstand rating of not inherent stable MPCBs up to 50 kA at 400 volts area

Modules	Wiring diagram	Contacts	Article no.	Weight g/each	Pack. unit
---------	----------------	----------	-------------	---------------	------------



Auxiliary contact for side mounting					
12 M		2 NO	HMS20	40	5
12 M		1 NO + 1 NC	HMS11	40	5
12 M		1 NO	HMS10	40	5
12 M		2 NC	HMS02	40	5
12 M		1 NC	HMS01	40	5



Early make auxiliary contact for side mounting					
12 M		1 NO + 1 NC	VHMS11	40	5
12 M		2 NO	VHMS20	40	5

Wiring diagram	Contacts	Article no.	Weight g/each	Pack. unit
----------------	----------	-------------	---------------	------------





Auxiliary contact for inside mounting

	1 NO + 1 NC	EHMS11	25	10
---	-------------	---------------	----	----





Trip-indicating auxiliary contact for inside mounting

	1 NO	SHMS10	25	10
	1 NC	SHMS01	25	10



Auxiliary contact for front mounting

	1 NO + 1 NC	FHMS11	13	10
	1 NO	FHMS10	11	10
	1 NC	FHMS01	11	10

Can not be used together with EHMS, SHMS, AMS and UMS.

Technical Data	HMS, VHMS	FHMS	SHMS
Rated impulse withstand voltage U_{imp}	4.000 V		
Rated operating voltage U_e	500 V	250 V	500 V
Overtoltage category/Pollution level	III/3	III/3	III/3
Max. current (with free air circulation) I_{ej}	6A	5A	6A
Rated operating current I_n AC-15 duty, 230 V / 400 V	3,5/2 A	1 A/-	2/1 A
Can also be used for low voltage and PLC-inputs	24 V DC, 10 mA		
Cross section: 1 conductor mm ² 2 conductor mm ² only HMS, VHMS	0,75 – 2,5 r; 0,75 – 1,5 l (with ferrule) 0,75 – 2,5 r; 0,75 – 1,5 l (with ferrule)		

It is possible to equip the breakers with different auxiliary contacts. Auxiliary contacts HMS, FHMS and EHMS operate in accordance with the main contacts. They are designed for remote signaling, electrical interlocking and control applications. Early make contacts VHMS operate earlier than the main contacts. Trip-indicating auxiliary contacts SHMS operate in case of a fault.

Rated operating voltage	Article no.	Weight g/each	Pack unit
-------------------------	-------------	---------------	-----------



Shunt trip for inside mounting with connecting cable (140 mm long)

110 V 50 Hz, 120 V 60 Hz	AMS110	75	10
220-230V 50 Hz, 240 V 60 Hz	AMS220	75	10
380-415 V 50 Hz, 440 V 60 Hz	AMS380	75	10
24 V 50/60 Hz	AMS24	75	10
500 V 50 Hz	AMS500	75	10
24 V DC	AMSD24	75	10

Pull-in voltage $0,7 \times U_n$

Switch in duration for U_n 100 % AC

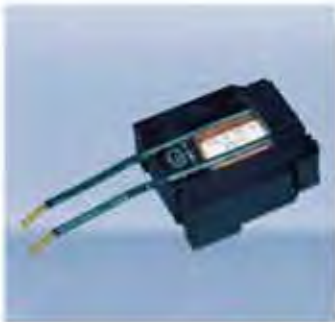
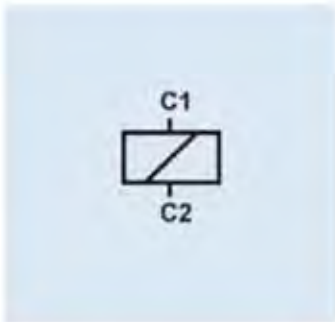

Undervoltage trip for inside mounting with connecting cable (140 mm long)

110 V 50 Hz, 120 V 60 Hz	UMS110	75	10
220-230 V 50 Hz, 240 V 60 Hz	UMS220	75	10
380-415 V 50 Hz, 440 V 60 Hz	UMS380	75	10
24 V 50/60 Hz	UMS24	75	10
500 V 50 Hz	UMS500	75	10

Pull-in voltage $\geq 0,85 \times U_n$

Drop out voltage $0,35-0,7 \times U_n$

Switch in duration for U_n 100%

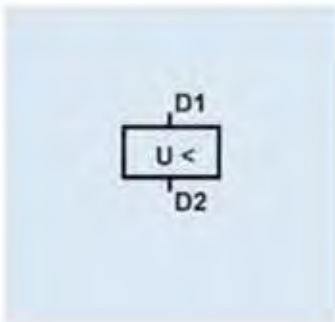



Insulated enclosure IP 41
with integrated PE(N) terminal
top and bottom each 2 metric
knock-outs

Article no.	Weight g/each	Pack. unit
MS.G41	220	1



Insulated enclosure with IP54 SCHUKO earthed plug
with 2 earthing systems
acc. to CEE7/VII
16 A 250 V, 2-pole + ⊕
1 opening at the bottom

Poles	Article no.	Weight g/each	Pack. unit
2-pole + ⊕	MS.C21	410	1



Insulated enclosure IP 55
with integrated PE(N) terminal
top and bottom each 2 metric
knock-outs

Article no.	Weight g/each	Pack. unit
MS.G55	240	1



Insulated enclosure with CEE-plug IP 54
16 A 400 V
1 opening at the bottom

Poles	Article no.	Weight g/each	Pack. unit
5-pole	MS.C51	420	1
4-pole	MS.C41	415	1
3-pole	MS.C31	410	1



Insulated flush mounting enclosure IP 41
with integrated PE(N) terminal

Article no.	Weight g/each	Pack. unit
MS.F41	150	1



Insulated enclosure with CEE-plug IP 54 and phase-inverter
16 A 400 V
1 opening at the bottom

Poles	Article no.	Weight g/each	Pack. unit
5-pole	MS.P51	420	1



Insulated flush mounting enclosure IP 55
with integrated PE(N) terminal

Article no.	Weight g/each	Pack. unit
MS.F55	170	1



Stop button
not latching
red, on grey surface

Article no.	Weight g/each	Pack. unit
MS.PT	55	5



Padlocking facility
for up to three padlocks

Article no.	Weight g/each	Pack. unit
MS.VS	100	10



Emergency-stop button
latching,
turn to release
red, on yellow surface

Article no.	Weight g/each	Pack. unit
MS.PV	60	5



Kit IP55
to increase degree of protection
from IP 41 to IP 55

Article no.	Weight g/each	Pack. unit
MS.BS	25	10



Emergency-stop button
latching,
key release (2 keys)
red, on yellow surface

Article no.	Weight g/each	Pack. unit
MS.PS2	65	5



N-Terminal
connecting of fifth conductor

Article no.	Weight g/each	Pack. unit
MS.N	10	10



Indicator light
with glow bulb,
nominal rated voltage: 220 – 240 V

Colour	Article no.	Weight g/each	Pack. unit
transp.	MS.SLW2	10	5
green	MS.SLG2	10	5
red	MS.SLR2	10	5
yellow	MS.SLJ2	10	5



Indicator light
with glow bulb,
nominal rated voltage: 380 – 440 V

Colour	Article no.	Weight g/each	Pack. unit
transp.	MS.SLW3	10	5
green	MS.SLG3	10	5
red	MS.SLR3	10	5
yellow	MS.SLJ3	10	5

Description	Max. busbar current (A)	Length	Article no.	Weight g/each	Pack. unit
-------------	-------------------------	--------	-------------	---------------	------------

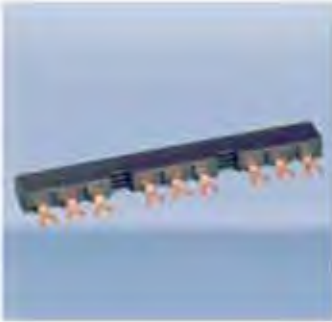

Busbars

for 2 MPCBs without auxiliary contacts	63	90 mm	SB.D02	37	10
for 3 MPCBs without auxiliary contacts	63	136 mm	SB.D03	55	10
for 4 MPCBs without auxiliary contacts	63	180 mm	SB.D04	75	10
for 2 MPCBs each with 1 auxiliary contact fitted on the right side	63	99 mm	SB.D12	40	10
for 3 MPCBs each with 1 auxiliary contact fitted on the right side	63	153 mm	SB.D13	65	10
for 4 MPCBs each with 1 auxiliary contact fitted on the right side	63	207 mm	SB.D14	90	10
for 5 MPCBs each with 1 auxiliary contact fitted on the right side	63	261 mm	SB.D15	115	10
for 2 MPCBs each with 2 auxiliary contacts	63	108 mm	SB.D22	45	10
for 4 MPCBs each with 2 auxiliary contacts	63	234 mm	SB.D24	105	10



Incoming terminal block

	63		SB.DE1	30	10
--	----	--	---------------	----	----



Shroud

			SB.DA1	5	10
--	--	--	---------------	---	----

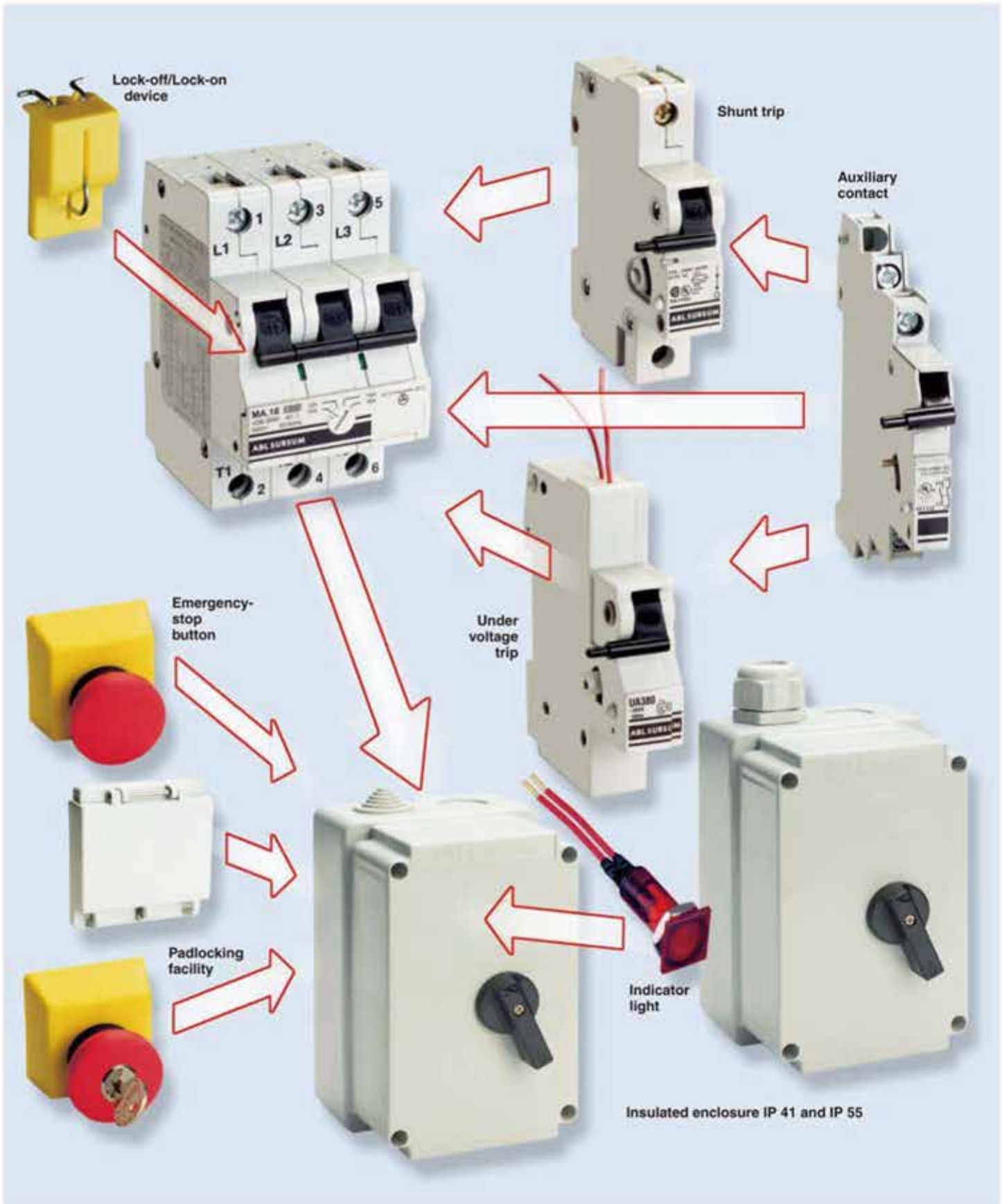

Technical Data		
Standards	IEC 60947-2, DIN EN 60947-2, VDE 0660-101 IEC 60947-4-1, DIN EN 60947-4-1, VDE 0660-102 DIN VDE 0100, DIN VDE 0110, DIN VDE 0113	
Short circuit withstand rating	10 kA at 240/415 V~	
Utilization category	AC 3 at U_n 415 V~ (up to I_n 25 A)	
Max. back-up fuse	Fuse according to DIN-VDE 0636 100A operating class gL for 240/415 V~ (only for $I_n > 10$ A)	
Rated voltage	500 V~ / 50-60 Hz	
Rated current range	15 setting ranges from 0.1 up to 40 A	
Rated uninterrupted current I_{th}	40 A	
Tripping time at $6 \times I_n$	$> 5s/TI$	
Test currents	Thermal not tripping I_1 (A) > 2 h	$1,05 \times I_n$
	Thermal tripping I_2 (A) < 2 h	$1,2 \times I_n$
	Electromagnetic not tripping I_4 (A) $> 0,1$ s	for the lower setting $16 \times I_n$ ($12,5 \times I_n > 16$ A) for the upper setting $10 \times I_n$
	Electromagnetic tripping I_5 (A) $< 0,1$ s	for the lower setting $19 \times I_n$ ($15 \times I_n > 16$ A) for the upper setting $12 \times I_n$
Temperature compensation	up to $+40^\circ$ C	
Permitted ambient temperature	open -20° C to $+50^\circ$ C, enclosure -20° C to $+40^\circ$ C storage/transport -40° C to $+70^\circ$ C	
Device depth according to DIN 43880	68 mm	
Mechanical endurance	30000 switching cycles (30 000 ON / 30 000 OFF)	
Permitted operating frequency	30 switching cycles/h	
Protection cover	Safe for fingers and back of hand acc. to DIN EN 50274, VDE 0660-514 BGV A2	
Degree of protection according to EN/IEC 60529	IP 20	
Installation position	Any	
Mounting	On din-rail acc. to DIN EN 60715 35 mm	
Lockability	The handle can be secured against manual switching in the on and off position by a lead seal	
Climatic resistance	Humid heat constant according to DIN IEC 60068-2-78 Humid heat cyclic according to DIN EN 60068-2-30	
Vibration resistance	> 15 g according to DIN EN 60068-2-59 for a load with I_1	
Resistance to mechanical shocks	25 g 11 ms	

Conductor cross sections				
Type of conductor	Box terminal bottom		Box terminal top	
	max.	min.	max.	min.
Single wire	25 mm ²	0,5 mm ²	25 mm ²	0,5 mm ²
Multiple wire	25 mm ²	(16 mm ²)	25 mm ²	(16 mm ²)
Stranded wire	16 mm ²	0,5 mm ²	16 mm ²	0,5 mm ²
Stranded wire with ferrule	16 mm ²	0,5 mm ²	16 mm ²	0,5 mm ²
Busbar Cable lug	up to 3 mm thickness		up to 1,5 mm thickness	
Combined, conductor and busbar or cable lug	up to 25 mm ² and up to 2 mm thickness		not possible	
Torque	max. 2 Nm			

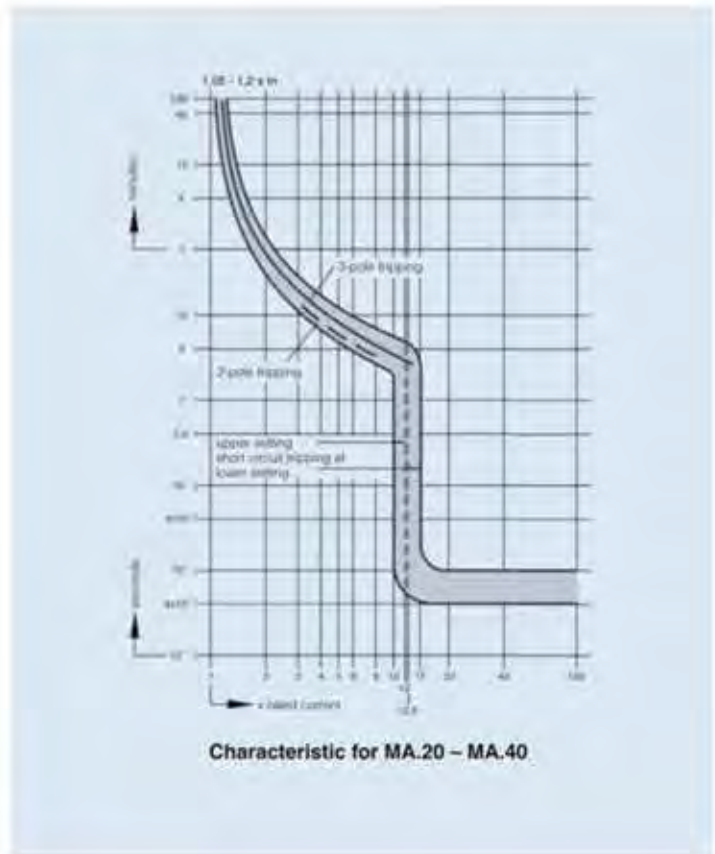
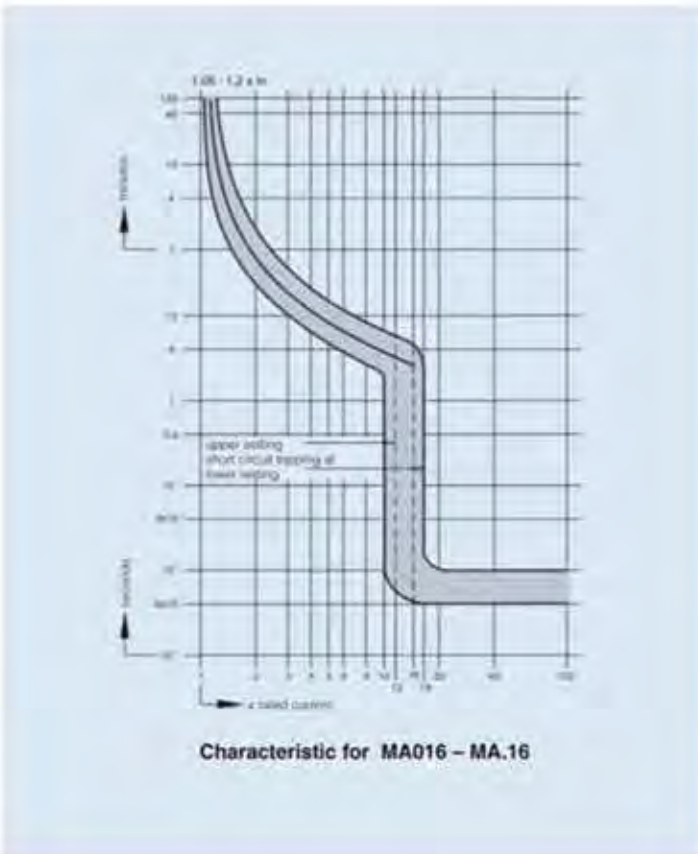

Nominal rated motor currents

Nominal rated motor currents for three-phase motors (reference values for cage rotors)

Lowest possible short circuit fuse for three-phase motors. The maximum value is calculated according to setting range.

Motor power			230 V			400 V			500 V			690 V		
kW	cos. φ	%	Nominal rated motor current	Fuse	Y/Δ	Nominal rated motor current	Fuse	Y/Δ	Nominal rated motor current	Fuse	Y/Δ	Nominal rated motor current	Fuse	Y/Δ
			A	A	A	A	A	A	A	A	A	A	A	A
0,06	0,7	58	0,37	2	-	0,21	2	-	0,17	2	-	0,12	2	-
0,09	0,7	60	0,54	2	-	0,31	2	-	0,25	2	-	0,18	2	-
0,12	0,7	60	0,72	4	2	0,41	2	-	0,33	2	-	0,24	2	-
0,18	0,7	62	1,04	4	2	0,6	2	-	0,48	2	-	0,35	2	-
0,25	0,7	62	1,4	4	2	0,8	4	2	0,7	2	-	0,43	2	-
0,37	0,72	62	2	6	4	1,2	4	2	0,9	2	2	0,7	2	-
0,55	0,75	69	2,7	10	4	1,5	4	2	1,2	4	2	0,9	4	2
0,75	0,78	74	3,2	10	4	1,9	6	4	1,5	4	2	1,1	4	2
1,1	0,81	74	4,6	10	6	2,6	6	4	2,1	6	4	1,5	4	2
1,5	0,81	74	6,3	16	10	3,6	6	4	2,9	6	4	2,1	6	4
2,2	0,81	78	8,7	20	10	5	10	6	4	10	4	2,9	10	4
3	0,82	80	11,5	25	16	6,6	16	10	5,3	16	6	3,8	10	4
4	0,82	83	14,8	32	16	8,5	20	10	6,8	16	10	4,9	16	6
5,5	0,82	86	19,6	32	25	11,3	25	16	9	20	16	6,5	16	10
7,5	0,82	87	26,4	50	32	15,2	32	16	12,1	25	16	8,8	20	10
11	0,84	87	38	80	40	21,7	40	25	17,4	32	20	12,6	25	16
15	0,84	88	51	100	63	29,3	63	32	23,4	50	25	17	32	20
18,5	0,84	88	63	125	80	36	63	40	28,9	50	32	20,9	32	25
22	0,84	92	71	125	80	41	80	50	33	63	32	23,8	50	25
30	0,85	92	96	200	100	55	100	63	44	80	50	32	63	32
37	0,86	92	117	200	125	68	125	80	54	100	63	39	80	50
45	0,86	93	141	250	160	81	160	100	65	125	80	47	80	63
55	0,86	93	173	250	200	99	200	125	79	160	80	58	100	63
75	0,86	94	233	315	250	134	200	160	107	200	125	78	160	100
90	0,86	94	279	400	315	161	250	200	129	200	160	93	160	100
110	0,86	94	342	500	400	196	315	200	157	250	160	114	200	125
132	0,87	95	401	630	500	231	400	250	184	250	200	134	250	160
160	0,87	95	486	630	630	279	400	315	224	315	250	162	250	200
200	0,87	95	607	800	630	349	500	400	279	400	315	202	315	250
250	0,87	95	-	-	-	437	630	500	349	500	400	253	400	315
315	0,87	96	-	-	-	544	800	630	436	630	500	316	500	400
400	0,88	96	-	-	-	683	1000	800	547	800	630	396	630	400
450	0,88	96	-	-	-	769	1000	800	615	800	630	446	630	630
500	0,88	97	-	-	-	-	-	-	-	-	-	491	630	630
560	0,88	97	-	-	-	-	-	-	-	-	-	550	800	630
630	0,88	97	-	-	-	-	-	-	-	-	-	618	800	630

The nominal rated motor currents are valid for normal three-phase motors with surface and internal surface cooling with 1500 min⁻¹.

Start-up direct: Start-up current max. 6 x nominal rated motor current
Start-up time max. 5 s.

Y/Δ Start-up: Start-up current max. 2 x nominal rated motor current
Start-up time max. 15 s.
Set motor circuit breaker relays in a line to 0.58 x protective nominal rated motor current.

Nominal rated fuse currents for Y/Δ starts are also valid for three-phase motors with slip ring rotors.

Use larger fuses for a higher rated current, start-up current and/or a longer start-up time.

The table is valid for "delayed-action" or "gI" fuses (DIN VDE 0636)

For NH-fuses with aM characteristic, fuse = nominal rated current is selected.

Rated current A	Max. rated operating power (kW/AC 3)			Operating current short circuit trip (A)	Article no.	Weight g/each	Pack. unit
	400/415 V	500 V	690 V				

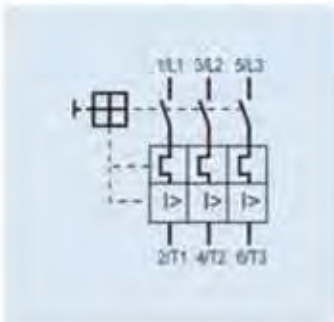

MA with overload and short circuit tripping
Temperature compensation can be set between +20°C and +40°C

Rated current (A)	400/415 V (kW)	500 V (kW)	690 V (kW)	Operating current (A)	Article no.	Weight (g)	Pack. unit
0,1 – 0,16	–	–	–	1,92	MA016	450	1
0,16 – 0,25	0,06	0,06	–	3	MA025	450	1
0,25 – 0,4	0,09	0,12	–	4,8	MA040	450	1
0,4 – 0,63	0,12	0,25	–	7,8	MA063	450	1
0,63 – 1	0,25	0,37	–	12	MA1.0	450	1
1 – 1,6	0,55	0,75	–	19,2	MA1.6	450	1
1,6 – 2,5	0,75	1,1	–	30	MA2.5	450	1
2,5 – 4	1,5	2,2	–	46	MA4.0	450	1
4 – 6,3	2,2	3	–	75,6	MA6.3	450	1
6,3 – 10	4	4	–	120	MA.10	450	1
10 – 16	7,5	9	–	192	MA.16	450	1
16 – 20	9	12,5	–	240	MA.20	450	1
20 – 25	12,5	15	–	300	MA.25	450	1
25 – 32	15	18,5	–	240	MA.32	450	1
32 – 40	18,5	22	–	300	MA.40	450	1

The MA motor protective circuit breaker offers optimal protection for motors and other loads up to 40A, due to its high breaking capacity with strongly limited current.

Rated current ranges up to 10 A are inherently stable at 400/415V and up to any higher short circuit currents. The ranges > 10 A have a short circuit withstand rating of 10 kA.

The handle drive provides a clear change-over display, in addition the contact position is displayed by a window.

The MA motor protective circuit breaker has the same construction as the miniature circuit breaker and can be mounted on the same busbar in distribution boards and cabinets.

Installed in an insulated enclosure, the device can be used as a main circuit breaker and can also be equipped with an emergency stop device.

Accessories

for UL miniature circuit breakers and motor protective circuit breakers MA



Shunt trip					
Module	Rated operating voltage	Max. operating current at U_n ($t < 10$ ms)	Article no.	Weight g/each	Pack. unit
1	12 V \approx	1,3 A	FA12U	105	5
1	24 V \approx	0,6 A	FA24U	105	5
1	48 - 72 V \approx	0,2 A	FA48U	105	5
1	110 - 240 V \approx , 415 V \approx	0,25 A bei 110 V 0,5 A bei 240 V 0,8 A bei 415 V	FA110U	105	5
Pull-in voltage $0,7 \times U_n$			Switch in duration at U_n 100%		



Undervoltage trip (50 Hz)					
Module	Rated voltage	Article no.	Weight g/each	Pack. unit	
1	24 V	UA.24	150	5	
1	110 V	UA110	150	5	
1	220 V	UA220	150	5	
1	240 V	UA240	150	5	
1	380 V	UA380	150	5	
1	415 - 440 V	UA415	150	5	
Pull-in voltage $\geq 0,85 \times U_n$		Drop-out voltage $0,35 - 0,7 \times U_n$		Switch in duration at U_n 100%	



Busbars							
Cross section (mm ²)	Busbar current Start of busbar/ Middle feed	Modules/ Phases	Article no.	Weight g/each	Pack. unit	Suitable end cap Art. no.	
3 phase							
10	63/100	4/3	SB31210	64	25	SB A1	
10	63/100	19/3	SB36010	420	20	SB A1	
16	80/130	19/3	SB36016	675	20	SB A2	
3 phase 3-pole circuit breaker + auxiliary contact							
16	80/130	16/3	SB36316	630	20	SB A2	



Distance device 9 mm

Module	Art. no.	Weight g/each	Pack. unit
1/2	HDS	7	10



Lock-off/Lock-on device

For miniature circuit breakers and motor protective circuit breakers

Art. no.	Weight g/each	Pack. unit
EASS	4	10

for UL miniature circuit breakers and motor protective circuit breakers MA



Auxiliary contact					
Module	Type of contact	Contacts	Article no.	Weight g/each	Pack. unit
1/2	1 Auxiliary contact	1NO	H10U	35	10
1/2	2 Auxiliary contacts	1NO + 1NC	H11U	40	10
1/2	3 Auxiliary contacts	1NO + 2NC	H12U	45	10
1/2	3 Auxiliary contacts	2NO + 1NC	H21U	45	10

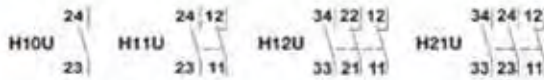

Standards	according to IEC 60947-5-1, DIN EN 60947-5-1, VDE 0660-200, UL 508	
Rated operating currents	10 A / 240 V AC 3 A / 110 V DC 1 A / 220 V DC	
Minimum contact load	1mA at 24 V DC	
Conductor cross sections		
Type of conductor	min.	max.
Single wire	0,5 mm ²	2,5 mm ²
Stranded wire	0,5 mm ²	1,5 mm ²
Stranded wire with ferrule	0,5 mm ²	1,5 mm ²
Torque	max. 0,7 Nm	



Insulated enclosure
IP 41
with PE terminal

Colour	Art. no.	Weight g/each	Pack. unit
grey	MA.G41	340	1

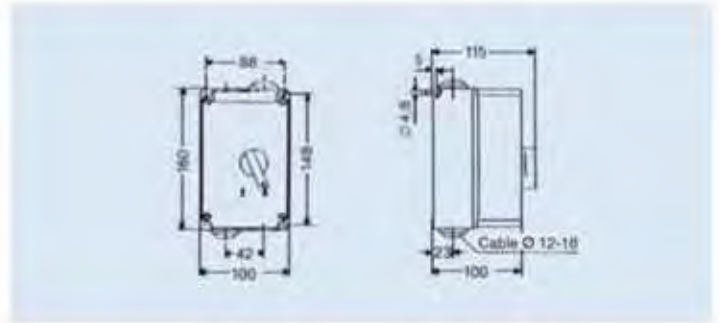

Insulated enclosure
IP55
with PE terminal

Colour	Art. no.	Weight g/each	Pack. unit
grey	MA.G55	390	1

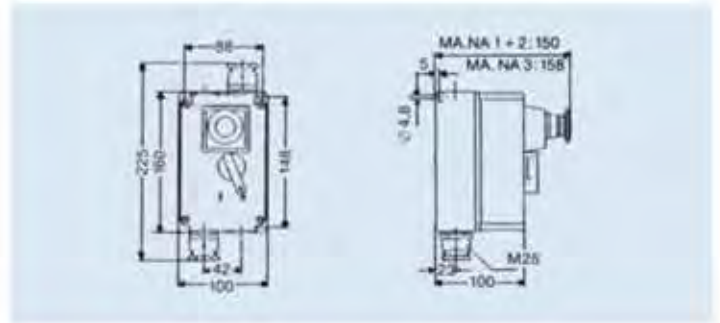

Emergency-stop button
not latching,
red, on yellow surface

Art. no.	Weight g/each	Pack. unit
MA.NA1	63	1



Padlocking facility
for max. 3 padlocks
lock bracket Ø 4 - 8 mm

Art. no.	Weight g/each	Pack. unit
MA.VS	45	1



Emergency-stop button
latching,
turn-to-release
red, on yellow surface

Art. no.	Weight g/each	Pack. unit
MA.NA2	63	1



N/PE terminal
retrofit.

Art. no.	Weight g/each	Pack. unit
MA.PE	20	10



Emergency-stop button
latching,
key release
red, on yellow surface

Art. no.	Weight g/each	Pack. unit
MA.NA3	85	1

Indicator light with glow bulb

U _e (V)	Colour	Art. no.	Weight g/each	Pack. unit
110 - 230	white	MA.SLW1	10	5
110 - 230	green	MA.SLG1	10	5
110 - 230	red	MA.SLR1	10	5
230 - 400	white	MA.SLW2	10	5
230 - 400	green	MA.SLG2	10	5
230 - 400	red	MA.SLR2	10	5
415 - 500	white	MA.SLW3	10	5
415 - 500	green	MA.SLG3	10	5
415 - 500	red	MA.SLR3	10	5

Rated current A	Max. rated operating power (kW/AC 3)			Operating current short circuit trip (A)	Article no.	Weight g/each	Pack. unit
	400/415 V	500 V	690 V				



MA with overload and short circuit tripping
Temperature compensation can be set between +20°C and +40°C



Rated current (A)	400/415 V (kW)	500 V (kW)	690 V (kW)	Operating current (A)	Article no.	Weight (g)	Pack. unit
0,1 – 0,16	–	–	–	1,92	MA0.16U	450	1
0,16 – 0,25	0,06	0,06	–	3	MA0.25U	450	1
0,25 – 0,4	0,09	0,12	–	4,8	MA0.40U	450	1
0,4 – 0,63	0,12	0,25	–	7,6	MA0.63U	450	1
0,63 – 1	0,25	0,37	–	12	MA1.0U	450	1
1 – 1,6	0,55	0,75	–	19,2	MA1.6U	450	1
1,6 – 2,5	0,75	1,1	–	30	MA2.5U	450	1
2,5 – 4	1,5	2,2	–	48	MA4.0U	450	1
4 – 6,3	2,2	3	–	75,6	MA6.3U	450	1
6,3 – 10	4	4	–	120	MA10U	450	1
10 – 16	7,5	9	–	192	MA16U	450	1
16 – 20	9	12,5	–	240	MA20U	450	1
20 – 25	12,5	15	–	300	MA25U	450	1
25 – 32	15	18,5	–	240	MA32U	450	1
32 – 40	18,5	22	–	300	MA40U	450	1

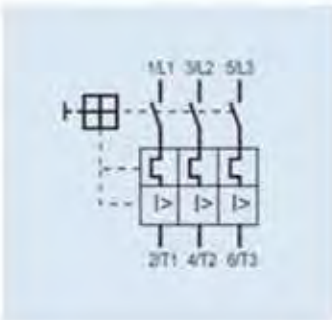

Accessories

according to UL 508 and CSA-22.2 No.14



Auxiliary contact

Module	Type of contact	Contacts	Article no.	Weight g/each	Pack. unit
1/2	1 contact	1NO	H10U	35	10
1/2	2 contacts	1NO + 1NC	H11U	40	10
1/2	3 contacts	1NO + 2NC	H12U	45	10
1/2	3 contacts	2NO + 1NC	H21U	45	10

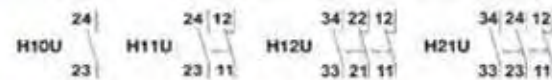

Shunt trip

Module	Rated operating voltage	Max. operating current at U_n (t < 10 ms)	Article no.	Weight g/each	Pack. unit
1	12 V~	1,3 A	FA12U	105	5
1	24V~	0,6 A	FA24U	105	5
1	48 - 74 V~	0,2 A	FA48U	105	5
1	110 - 240 V ~, 415 V~	0,25 A at 110 V 0,5 A at 240 V 0,6 A at 415 V	FA110U	105	5



ABL SURSUM
Bayerische Elektrozubehör GmbH & Co. KG

Ottensooser Strasse 22
 D-91207 Lauf / Pegnitz
 Germany

Telephone: +49 (0)9123 188-0
 Facsimile: +49 (0)9123 188-188

Postfach 10 02 47
 D-91192 Lauf / Pegnitz
 Germany

E-Mail: info@abl-sursum.com
 Internet: www.abl-sursum.com

JD Auspice Co.,Ltd.

Tel : 886-2-8991-2796

Fax : 886-2-8991-9298

Mail : service@jdauspice.com

Web : <http://www.jdauspice.com>

Subject to technical alterations
 000051 / 06.2007