

2009/10



Switching Devices

JD Auspice Co.,Ltd.

Tel : 886-2-8991-2796

Fax : 886-2-8991-9298

Mail : service@jdauspice.com

Web : <http://www.jdauspice.com>

Editorial



**Dear Customers,
Dear Business Partners,**

with this catalogue we would like to invite you to explore the multi-faceted world of modern electronic installation devices. There is so much waiting to be discovered. But regardless of which product you choose, with ABL SURSUM you are choosing TRADITION and QUALITY, INNOVATION and EMOTION.

We are a traditional family-owned company and are filled with pride that, more than 80 years after the invention of the SCHUKO system, we are able to offer you one of the most extensive ranges of products in the area of electrical installation technology in a time of rapid change and accelerating globalisation.

Quality is the decisive factor for us. With proven materials, first-class workmanship and the highest quality standards, ABL SURSUM products are ideal for use in industry and small trade.

Only those who are open to change will be successful in the future. This guiding principle is what motivates us daily to make sure that we always use state-of-the-art technology, do not remain still, and continuously develop products innovatively for our customers with the most modern means available.

At ABL SURSUM, emotion is the enthusiasm for successful products. That is why we always work closely with our customers and can meet their specific requirements and offer individual solutions as quickly as possible. Our excellent service is always at your side, ready to provide support.

Sincerely

Dr. Stefan Schlutius
CEO





**Development:
Everything in-house**

Every new product begins with an idea. In order to implement it, a lot of experience and the right tools are needed. That is why development at ABL SURSUM is not only carried out with the most modern CAD software available, but also in constant dialogue with customers. Because it is only with exact knowledge of products and markets that one can create innovative, need-based products.

**Tool and equipment manufacture:
Focus on quality**

The quality of a production starts with the right production facilities. That is why ABL SURSUM builds and maintains its own custom plastic and metal machining tools. At the same time, a large proportion of the machines and equipment are constructed in our own equipment manufacturing facilities. Because if you plan and build something yourself, you can maintain it optimally, adjust it to meet new challenges and constantly develop it further.





**Quality control:
No compromises**

Permanent quality monitoring with the assistance of the most up-to-date inspection procedures is a matter of course at ABL SURSUM. That is why there are no compromises when it comes to monitoring ongoing production and the final inspections.

ABL SURSUM is also certified according to DIN ISO 9001.

**Logistics:
Service begins with delivery**

In this day and age of tighter and tighter schedules, a well-organised distribution network and modern logistics ensure on-time delivery to both domestic and foreign markets. This ensures that ABL SURSUM with an export rate of over 50%, can deliver daily on-time to numerous customers all over the world.





Representatives throughout Europe:

Belgium	Netherlands
Denmark	Norway
Estonia	Austria
Finland	Poland
France	Portugal
Greece	Romania
Great Britain	Sweden
Ireland	Switzerland
Italy	Slovakia
Latvia	Spain
Lithuania	Czech Republic
Luxemburg	Hungary



Our agents in Germany



- 1**
Wilhelm K. Junge
Inh. Klaus Kuhlmann
Papierreye 63
22453 Hamburg
Telefon: 0 40/5 53 71 65
Telefax: 0 40/5 53 71 80
E-Mail: wkjunge@aol.com
- 2**
**Elektrotechnische
Handelsvertretung
Steffen Klewe**
Angermünder Str. 1 d
12305 Berlin
Telefon: 0 30/72 01 60 19
Telefax: 0 30/72 01 60 21
E-Mail:
info@handelsvertretung-klewe.de
Internet:
www.handelsvertretung-klewe.de
- 3**
Geisthardt GmbH
Gewerbepark 8
26209 Hatten-Munderloh
Telefon: 0 44 82/92 88-12, -13
Telefax: 0 44 82/92 88-99
E-Mail:
matthias@geisthardt.de
Internet: www.geisthardt.de
- 4**
Frank Birr
Kurzer Weg 2
39291 Lostau
Telefon/Telefax: 039 222 / 67 336
Mobil: 0172/3 51 88 44
E-Mail:
frank.birr@abl-sursum.com

- 5/6**
SCHARDT oHG
Elektro-System-Technik
Bunsenstr. 10
42551 Velbert
Telefon: 0 20 51/28 06-0
Telefax: 0 20 51/28 06-29
E-Mail:
info@schardtohg.de
Internet: www.schardtohg.de
- 7**
Rainer Erk
Werner v. Siemens Straße 6a
63486 Bruchköbel
Telefon: 0 61 81/70 96 53
Telefax: 0 61 81/78 00 20
E-Mail: RainerErk@t-online.de
- 8**
Steffen Aehnelt
Seminarstr. 28
06618 Naumburg
Telefon: 0 34 45/23 73 96
Telefax: 0 34 45/23 73 99
Mobil: 0172/8 50 98 57
E-Mail: steffen.ahnelt@
abl-sursum.com
- 9**
ABL SURSUM
Bayerische Elektrozubehör GmbH
& Co. KG
Ottensosser Straße 22
91207 Lauf/Pegnitz
Telefon: 0 91 23/1 88 - 0
Telefax:
0 91 23/1 88 -188, -189
E-Mail:
info@abl-sursum.com
Internet:
www.abl-sursum.com

- 10**
Julius Vogt GmbH
Am Wasserturm 4
66265 Heusweiler-Holz
Telefon: 0 68 06/98 58-0
Telefax: 0 68 06/80 01 90
E-Mail:
info@vogt-online.de
- 11**
Roland Gohl GmbH
Bachstraße 13
72669 Unterensingen
Telefon: 0 70 22/24 45 45
Telefax: 0 70 22/24 45 40
E-Mail:
info@gohlgbmh.de
Internet:
www.gohlgbmh.de
- 12**
**Industrievertretung
Jana Clauss**
Klingbauerweg 1
85123 Karlskron
Telefon: 0 84 50/92 55 00
Telefax: 0 84 50/92 55 01
E-Mail: jana.clauss@gmx.net

**Building a future
means successfully advancing tradition.**

Circuit breakers are an 80 year old tradition at ABL SURSUM. The first screw-in circuit breaker came onto the market in 1925. The first high-performance circuit breaker followed less than 10 years later. These circuit breakers ushered in the long success story of ABL SURSUM circuit-protection devices.

With the miniature circuit breakers of the S, SL and T ranges, we now continue our success story. With a broad-ranging, product-specific knowledge and in cooperation with our customers, we have combined all those advantages in these innovative product ranges - making our miniature circuit breakers a trend-setting system range.

Application-orientation, functionality and the highest quality were just as important as reliable operation, maximum safety and effective time gain on installation.



New products for new market requirements

We meet the daily installation demands for ever more effectiveness and speed with our screwless clamping technology "plug2power". Our new generation of miniature circuit breakers, with their completely new design and technology, is divided into the three product ranges S, SL and T, and allow us to offer you numerous advantages in terms of functionality, compatibility, and quality.

The miniature circuit breakers of ABL SURSUM are so attractive because of the low height, clear design, clearly legible labels and the new mounting system, which allows for removing from a busbar combination below ("singlefix") with the S and SL range and both above and below with the T range ("twinfix").

This has created an ideal complete system for the wide-ranging installation requirements:

- Conventional house installations
- Industrial installation
- Industry applications, machine and system installation

The right products for each project.

1 Functional design

- Modern design
- User-friendly ergonomics
- Easy-to-understand product designation
- Clearly legible On/Off marking

2 Compact construction

- Minimum dimensions – with an installation height of 82,5 mm, one of the smallest miniature circuit breakers on the market
- Maximum saving of space for comfortable wiring

3 Easier busbar removal

- Innovative fixing slides for easy removal from a busbar combination
- No laborious moving of the mounted miniature circuit breakers
- “singlefix” for removal from a bottom-fixed busbar
- “twinfix” for removal from a busbar on both sides

single  **fix**

twin  **fix**

4 Screwless clamping technology

- Innovative, screwless connection technology “plug2power”
- Quick mounting – easy removal
- Highest wiring safety
- Extreme tensile load capacity
- Integrated test opening for voltage measurement

plug  **power**

5 Professional labelling system

- Optimal labelling concept for device marking
- Maximum communication safety
- Optically uniform, continuous labelling

pictoplan

6 Perfect compatibility

- Multi-system compatibility of the S, SL and T product ranges, the RCCBs and DIN-rail panel products
- Suitable for bottom busbar installation with previous products
- Use of standard busbars
- Attachments compatible with all product ranges

7 Optimum safety

- Maximum protection function for installation and use
- Fulfilling all applicable standards, approvals and degrees of protection

8 Highest quality

- Decades of experience and electro-technical expertise
- Consistent quality management without any compromises in the entire production cycle
- Tested three times and independently
- Optimum long-life cycle

9 Extensive application possibilities

- 3 product ranges of miniature circuit breakers for all application requirements
- Tripping characteristics B, C, D, K, Z

10 Complete product system

- Complete range of attachments and accessories
- The perfect supplement with a wide range of RCCBs and DIN-rail panel products for a multitude of switching and regulation tasks

Miniature Circuit Breakers

Design-oriented and function-oriented products

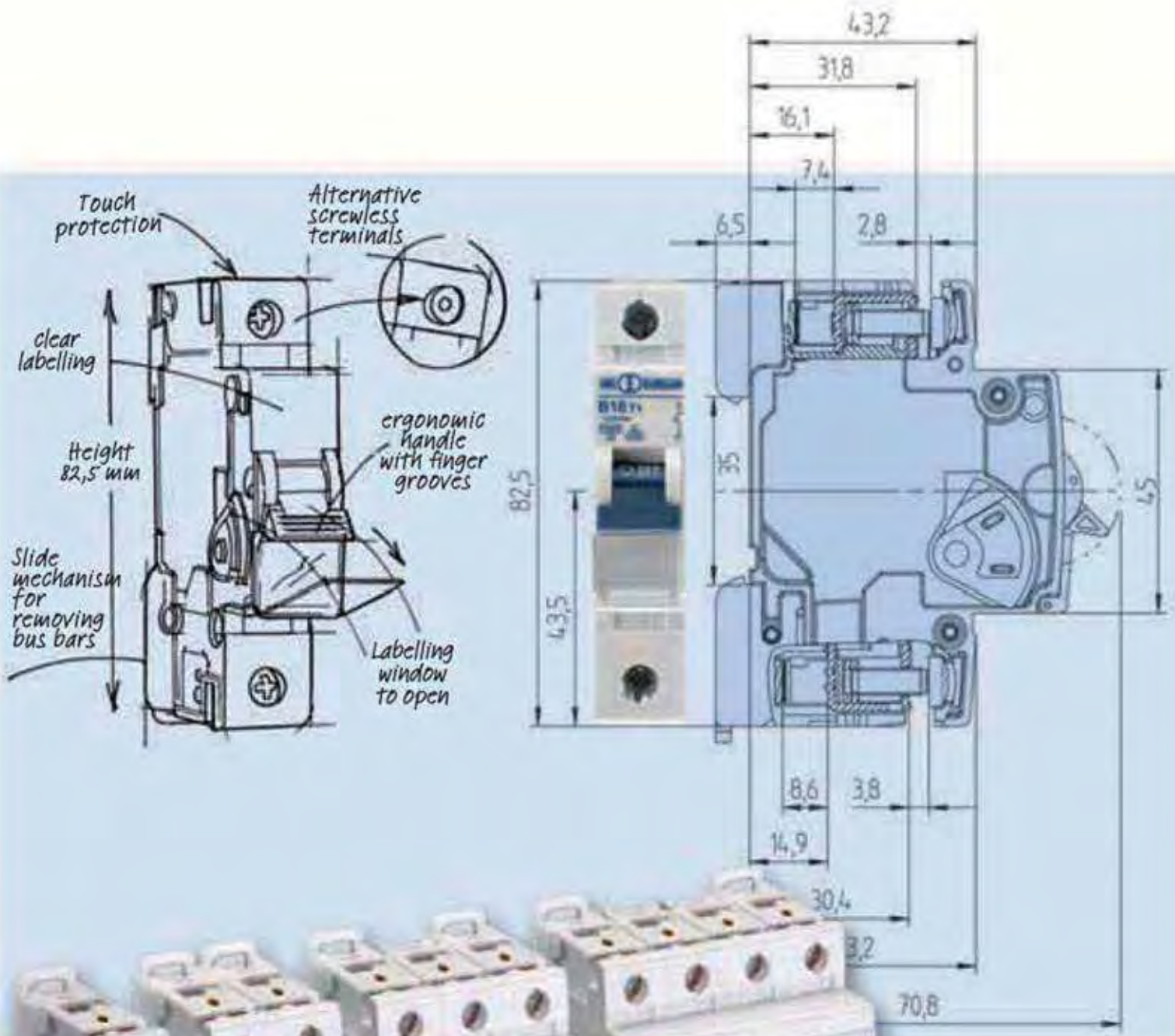

Easier removal of circuit breakers even for busbars at the top

- Innovative fixing slides for easy removal from a busbar combination on both sides
- No more time-consuming moving required

Particularly in the field of industrial installation technology, maximum flexibility for the highest requirements is often required. Quick mounting or replacing of miniature circuit breakers is one of the most important prerequisites to keep downtimes at the lowest possible level.



For the T range, we have developed an innovative system of two fixing slides that solves this problem perfectly: **twinfix**..



The two fixing slides enable removing from a busbar combination on both sides. This makes it possible to remove individual miniature circuit breakers without difficulty. Feasible with every standard busbar (busbars fork type).

A clear advantage for more installation flexibility..

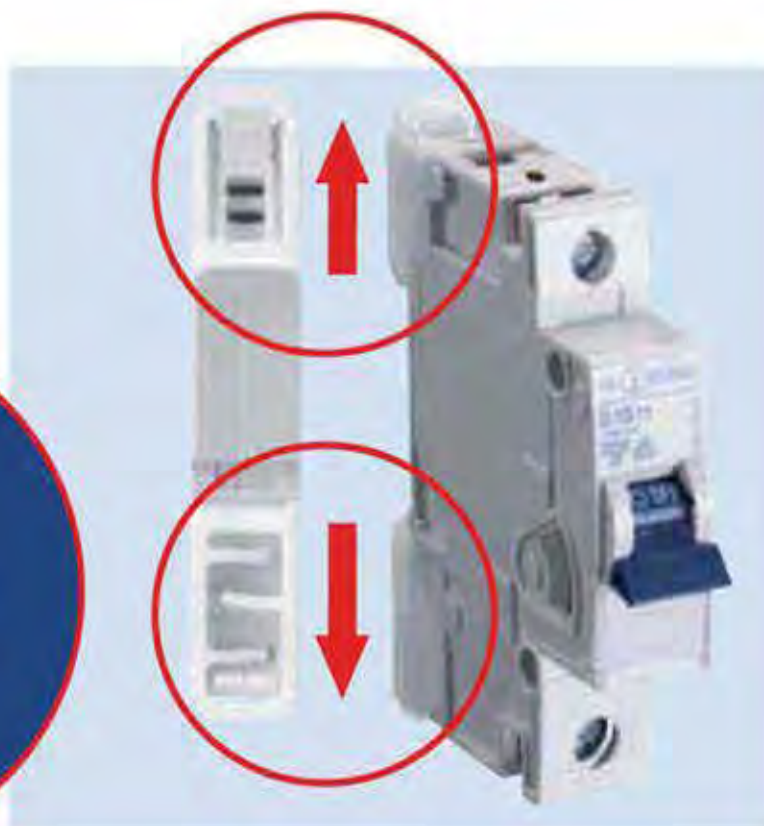

Systematic labelling – improving communication

5 Systematic labelling

- Optimal labelling concept for device marking
- Maximum communication safety
- Optically uniform, continuous labelling

ABL SURSUM miniature circuit breakers offer you all the options for individual and user-friendly labelling. The big transparent labelling window can easily be opened and closed. It holds your labels securely. Nothing gets soiled. Best requirements for good communication.



Simple communication: The "pictoplan" labelling sheet

Miniature circuit breakers are often not labelled because it simply takes too long. For this reason, we offer the "pictoplan" labelling sheet with pre-punched labelling symbols. Simply remove the symbols and insert them into the labelling window. Can be done quickly and looks perfect. Your customers will be pleased.

Another advantage for good communication.

pictoplan



Unlimited communication – the "pictoplan" labelling software

If the labelling symbols are not sufficient, we offer you the newly-developed, cost-free "pictoplan" labelling software. The perfect solution for machine and switchgear manufacturers to label several switching circuits individually with numbers and letters..

Simply order our free pictoplan CD or download it from the Internet at:
www.abl-sursum.com



Safety without compromise

7 Optimum safety

- Maximum protection function for installation and use
- Fulfilling all applicable standards, approvals and degrees of protection

Quality must be verifiable

ABL SURSUM miniature circuit breakers fulfil all legal standards and regulations – for the safety of our customers.

We are glad to have this certified:

ABL SURSUM miniature circuit breakers have successfully been approved by the VDE. Our miniature circuit breakers are, of course, finger-safe and safe for back-of-hand - without any restrictions.

A clear advantage for more safety.



The right product for every application

9 Extensive application possibilities

- 3 product ranges of miniature circuit breakers for all application requirements
- Tripping characteristics B, C, D, K, Z

The S Range.

With the S range, we offer you a practice-oriented product range of standardised 1-pole and 3-pole miniature circuit breakers with rated currents from $I_n = 6$ A to 32 A.

Low installation height, clearly legible labels and easy busbar removal allow for most convenient mounting.

If you need lower or higher rated currents for special applications, all miniature circuit breakers of this range can be combined with T-range products without any restrictions.

User-friendliness to the advantage of our customers.

The SL Range.

Focus consistently on the future

With the SL range, you receive a compact miniature circuit breaker that offers you all the advantages of the S range.

When it is necessary to guarantee time and cost advantages by fast mounting, our innovative "plug2power" connection technology comes into play.

Excellent efficiency

The practice-oriented products of the SL range comprise 1-pole and 3-pole miniature circuit breakers with rated currents from $I_n = 6$ A to 20 A. Just like the S range, the SL range is also compatible with T-range products without any restrictions.

This makes the miniature circuit breakers of the SL range ideal for house building - lowering mounting times and installation costs considerably.

State-of-the-art installation technology with excellent efficiency.

The T Range.

Individuality takes centre stage

ABL SURSUM also sees itself as your problem solver.

Where other products have to pass, our T range fulfils even difficult industrial requirements. It comprises all standard current strengths from 0.3 to 63 A and all common numbers of poles from 1-pole to 4-pole as well as with switched neutral.

The diversified range of tripping characteristics leaves nothing to be desired.

All miniature circuit breakers of the T range are, of course, designed for a rated switching capacity of 10 kA.

Every miniature circuit breaker of the T range can be removed from the busbar combination by means of the innovative mounting system "twinfix" without any problems.

Efficient for the highest requirements.

Your needs are our standard

If the miniature circuit breaker you require is not among our range of products, ABL SURSUM also manufactures customer-specific system products.



A diversified range of products – RCCBs and DIN-rail panel products

ABL SURSUM supplements its innovative product range with a multitude of RCCBs. Due to increased requirements and guidelines, modern electrical installations require products for many different fields of application. The complete range of products comprises A and B-type RCCBs (sensitive to universal current) in undelayed, short-time-delayed and selective design. Furthermore, combined RCBOs are now part of our range.



Circuit-breaker technology is one of the important areas of electrical installation. The second is additional control and switching devices. Using the most modern technology, they offer almost unlimited possibilities and maximum convenience for building and control technology. Our extensive, completely revised product range of DIN-rail panel products offers you the necessary components for modern and challenging electrical installations.

Thus, you can meet any challenge.



Rated current I_n A	Characteristic		Weight g/each	Packing unit
	B Article no.	C Article no.		



1-pole with switched neutral				
1		C1S8	240	6
2		C2S8	240	6
3		C3S8	240	6
4		C4S8	240	6
5		C5S8	240	6
6	B6S8	C6S8	240	6
10	B10S8	C10S8	240	6
13	B13S8	C13S8	240	6
16	B16S8	C16S8	240	6
20	B20S8	C20S8	240	6
25	B25S8	C25S8	240	6
32	B32S8	C32S8	240	6
40	B40S8	C40S8	250	6
50	B50S8	C50S8	270	6
63	B63S8	C63S8	270	6



2-pole				
1		C1S2	240	6
2		C2S2	240	6
3		C3S2	240	6
4		C4S2	240	6
5		C5S2	240	6
6	B6S2	C6S2	240	6
10	B10S2	C10S2	240	6
13	B13S2	C13S2	240	6
16	B16S2	C16S2	240	6
20	B20S2	C20S2	240	6
25	B25S2	C25S2	240	6
32	B32S2	C32S2	240	6
40	B40S2	C40S2	250	6
50	B50S2	C50S2	270	6
63	B63S2	C63S2	270	6



With screwless top terminal (plug2power)
6 kA B and C characteristic acc. to IEC 60898-1, DIN EN 60898-1, VDE 0641-11



Rated current I_n A	Characteristic		Weight g/each	Packing unit
	B Article no.	C Article no.		

1-pole				
6	B6SL1	C6SL1	120	12
10	B10SL1	C10SL1	120	12
13	B13SL1	C13SL1	120	12
16	B16SL1	C16SL1	120	12
20	B20SL1	C20SL1	120	12



3-pole				
6	B6SL3	C6SL3	360	4
10	B10SL3	C10SL3	360	4
13	B13SL3	C13SL3	360	4
16	B16SL3	C16SL3	360	4
20	B20SL3	C20SL3	360	4



plug2power

„plug2power“
SL product Range – the innovative screwless terminal
technology for fast and safe connections!



Simply safer installation with “plug2power”

“plug2power” plug terminals do not accept any compromises when it comes to safety. They are designed for massive conductors and flexible conductors (without ferrule) from 1 to 4 mm². The design of the double terminal even copes with higher tensile forces than screw terminals without difficulty – irrespective of the conductor cross sections used. An undesired release of the wiring connections is practically impossible due to the self-correcting forces of the tension spring.

The concept with a future

Two flicks of the wrist – and everything is in the right place. The compact and functional SL miniature circuit breaker is installed in a matter of seconds. Without having to use a screwdriver. Absolutely safe, with high tensile load capacity and maintenance-free.

Your advantage:
More time saving, more safety

10 kA B, C and D characteristic acc. to IEC 60898-1, DIN EN 60898-1, VDE 0641-11
10 kA K and Z characteristic acc. to IEC 60947-2, DIN EN 60947-2, VDE 0660-101

This product range differentiates between:

- Standard products for normal market applications (shown in the table in bold – delivery time approx. 2 weeks)
- Exclusive products for sector-specific applications (shown in the table in normal print – longer delivery time)

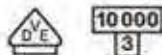

twin fix

Also available:
Miniature circuit breakers with a CB certificate in 80A / 100A / 125A type – however, these have a different design
Only approved as an export version!!



twin fix

Also available:
Miniature circuit breakers with a CB certificate in 80A / 100A / 125A type – however, these have a different design
Only approved as an export version!!

Rated current I_n A	Characteristic					Weight g/each	Packing unit
	B Article no.	C Article no.	D Article no.	K Article no.	Z Article no.		

2-pole							
0.3		C0.3T2	D0.3T2	K0.3T2	Z0.3T2	240	6
0.5		C0.5T2	D0.5T2	K0.5T2	Z0.5T2	240	6
0.8		C0.8T2	D0.8T2	K0.8T2	Z0.8T2	240	6
1	B1T2	C1T2	D1T2	K1T2	Z1T2	240	6
1.6		C1.6T2	D1.6T2	K1.6T2	Z1.6T2	240	6
2	B2T2	C2T2	D2T2	K2T2	Z2T2	240	6
2.5		C2.5T2	D2.5T2	K2.5T2	Z2.5T2	240	6
3	B3T2	C3T2	D3T2	K3T2	Z3T2	240	6
3.5		C3.5T2	D3.5T2	K3.5T2	Z3.5T2	240	6
4	B4T2	C4T2	D4T2	K4T2	Z4T2	240	6
5	B5T2	C5T2	D5T2	K5T2	Z5T2	240	6
6	B6T2	C6T2	D6T2	K6T2	Z6T2	240	6
8		C8T2	D8T2	K8T2	Z8T2	240	6
10	B10T2	C10T2	D10T2	K10T2	Z10T2	240	6
13	B13T2	C13T2	D13T2	K13T2	Z13T2	240	6
16	B16T2	C16T2	D16T2	K16T2	Z16T2	240	6
20	B20T2	C20T2	D20T2	K20T2	Z20T2	240	6
25	B25T2	C25T2	D25T2	K25T2	Z25T2	240	6
32	B32T2	C32T2	D32T2	K32T2	Z32T2	240	6
40	B40T2	C40T2	D40T2	K40T2		260	6
50	B50T2	C50T2	D50T2	K50T2		270	6
63	B63T2	C63T2	D63T2	K63T2		270	6

3-pole							
0.3		C0.3T3	D0.3T3	K0.3T3	Z0.3T3	360	4
0.5		C0.5T3	D0.5T3	K0.5T3	Z0.5T3	360	4
0.8		C0.8T3	D0.8T3	K0.8T3	Z0.8T3	360	4
1	B1T3	C1T3	D1T3	K1T3	Z1T3	360	4
1.6		C1.6T3	D1.6T3	K1.6T3	Z1.6T3	360	4
2	B2T3	C2T3	D2T3	K2T3	Z2T3	360	4
2.5		C2.5T3	D2.5T3	K2.5T3	Z2.5T3	360	4
3	B3T3	C3T3	D3T3	K3T3	Z3T3	360	4
3.5		C3.5T3	D3.5T3	K3.5T3	Z3.5T3	360	4
4	B4T3	C4T3	D4T3	K4T3	Z4T3	360	4
5	B5T3	C5T3	D5T3	K5T3	Z5T3	360	4
6	B6T3	C6T3	D6T3	K6T3	Z6T3	360	4
8		C8T3	D8T3	K8T3	Z8T3	360	4
10	B10T3	C10T3	D10T3	K10T3	Z10T3	360	4
13	B13T3	C13T3	D13T3	K13T3	Z13T3	360	4
16	B16T3	C16T3	D16T3	K16T3	Z16T3	360	4
20	B20T3	C20T3	D20T3	K20T3	Z20T3	360	4
25	B25T3	C25T3	D25T3	K25T3	Z25T3	360	4
32	B32T3	C32T3	D32T3	K32T3	Z32T3	360	4
40	B40T3	C40T3	D40T3	K40T3		375	4
50	B50T3	C50T3	D50T3	K50T3		405	4
63	B63T3	C63T3	D63T3	K63T3		405	4

Characteristic	B	C	D	K	Z	
Application	Wiring protection	Wiring protection Device protection	Wiring protection Power circuits Transformers Motors	Wiring protection Power circuits Transformers Motors	Wiring protection Semiconductor protection High impedance	
Number of poles						
Product range „S“	1-3; 1+N; 3+N		-	-	-	
Product range „SL“	1 and 3		-	-	-	
Product range „T“	1 - 4; 1 + N; 3 + N				1 - 3	
Standards short circuit withstand rating	IEC 60898-1, DIN EN 60898-1, VDE 0641-11			IEC 60947-2, DIN EN 60947-2, VDE 0660-101		
Product range „S“	6 kA	6 kA	-	-	-	
Product range „SL“	6 kA	6 kA	-	-	-	
Product range „T“	10 kA	10 kA	10 kA	10 kA	10 kA	
Current limiting class	3	3				
Max. back-up fuse	Fuse according to DIN VDE 0636 125 A operating class gL/gG					
Rated AC voltage	230 / 400 V					
Rated DC voltage L/R = 4 ms	1-pole 60 V, 2-pole 125 V in serial connection of both poles					
Rated current range I_n						
Product range „S“	6 - 32 A	6 - 32 A	-	-	-	
Product range „SL“	6 - 20 A	6 - 20 A	-	-	-	
Product range „T“	1 - 63 A	0,3 - 63 A	0,3 - 63 A	0,3 - 63 A	0,3 - 32 A	
Test currents	Thermal not tripping I_1 (A) > 1 h	$1,13 \times I_n$	$1,13 \times I_n$	$1,13 \times I_n$	$1,05 \times I_n$	$1,05 \times I_n$
	Thermal tripping I_2 (A) < 1 h	$1,45 \times I_n$	$1,45 \times I_n$	$1,45 \times I_n$	$1,2 \times I_n$	$1,35 \times I_n$
	Electromagnetic not tripping I_4 (A) > 0,1 s	$3 \times I_n$	$5 \times I_n$	$10 \times I_n$	$8 \times I_n$	$2 \times I_n$
	Electromagnetic tripping I_5 (A) < 0,1 s	$5 \times I_n$	$10 \times I_n$	$20 \times I_n$	$12 \times I_n$	$3 \times I_n$
Reference calibration temperature of the thermal tripping	30° C + 5° C			20° C + 5° C		
	influence of the ambient temperature on the thermal tripping: Decrease of the current values with higher ambient temperature and increase with lower temperatures of approximately 5% per 10° C difference in temperature					
Frequency range of the electromagnetic trip	16 ² / ₃ to 60 Hz With higher frequencies, the electromagnetic tripping values increase by approximately a factor of 1,1 at 100 Hz; 1,2 at 200 Hz; 1,3 at 300 Hz; 1,4 at 400 Hz; 1,5 for DC					
Ambient temperature	-25° C to +55° C					
Storage temperature	-40° C to +70° C					
Device depth acc. to DIN 43880	68 mm					
Mechanical endurance	20,000 switching cycles (20,000 ON / 20,000 OFF)					
Protection cover	Finger safe and safe to back of hand according to DIN EN 50274/ VDE0660-514, BGV A3					
Insulation group according to DIN VDE 0110	C at 250 V AC B at 400 V AC					
Degree of protection according to EN / IEC 60529	IP 20					
Installation position	any					
Mounting	DIN-rail according to DIN EN 60715-35 mm					
Lockability	The handle can be secured against manual switching in the on and off position by a lead seal					
Climatic resistance	Humid heat constant according to DIN IEC 60068-2-78 Humid heat cycle according to DIN EN 60068-2-30					
Vibration resistance	> 15 g according to DIN EN 60068-2-59 during a load with I_n					
Resistance to mechanical shocks	25g 11ms					

Miniature circuit breakers, **S product range** with screw terminals can be removed from a **BOTTOM-MOUNTED** busbar combination

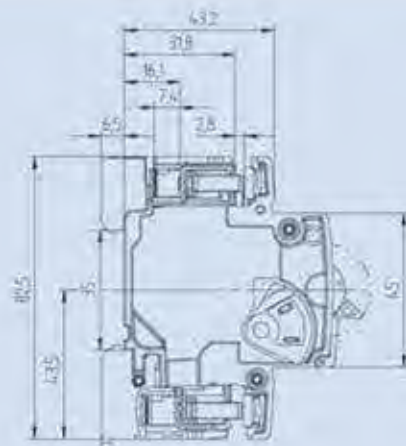
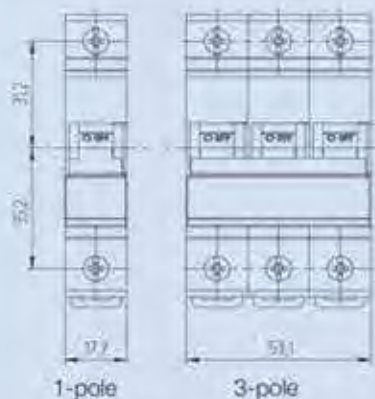

Miniature circuit breakers, **SL product range** with screwless terminals can be removed from a **BOTTOM-MOUNTED** busbar combination

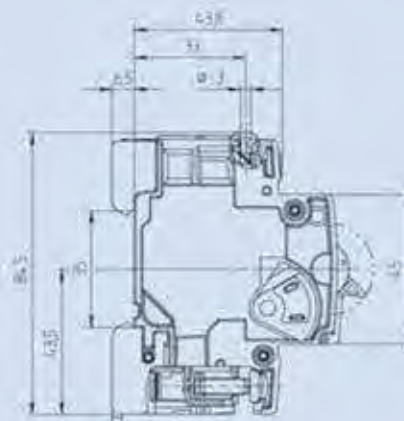
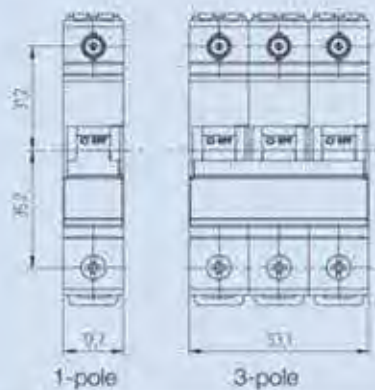

Miniature circuit breakers, **T product range** with screw terminals can be removed from a **TOP and BOTTOM-MOUNTED** busbar combination

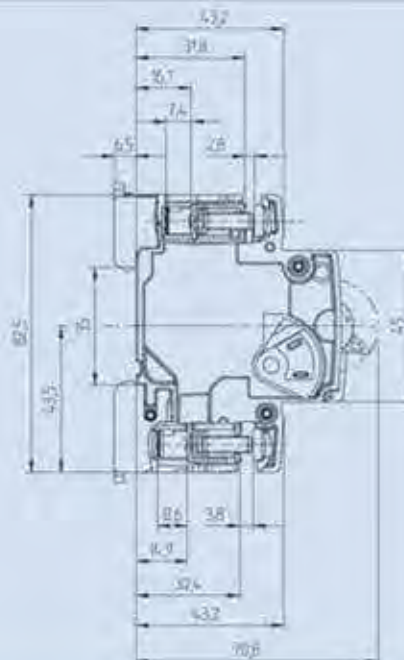
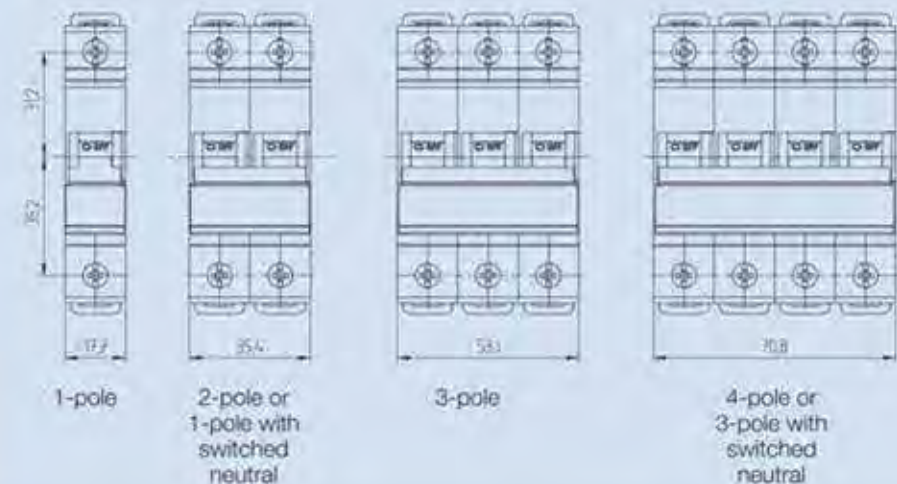

Characteristic
acc. to IEC 60947-2, DIN EN 60947-2 and VDE 0660-101

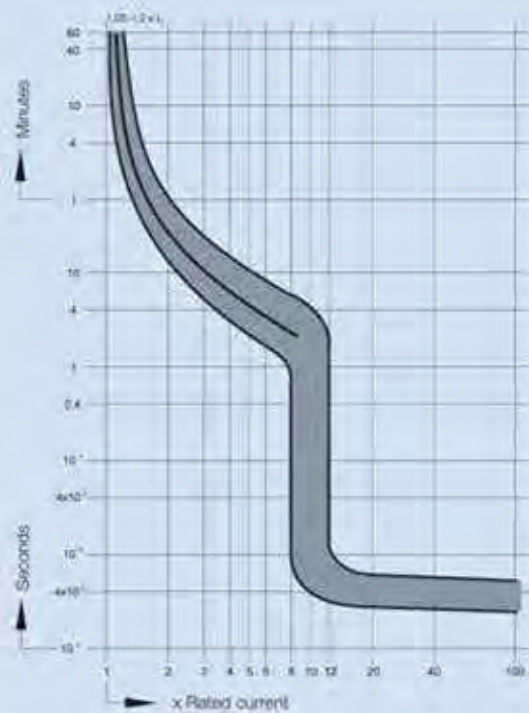

K characteristic $I_n = 0.3 - 10 \text{ A}$

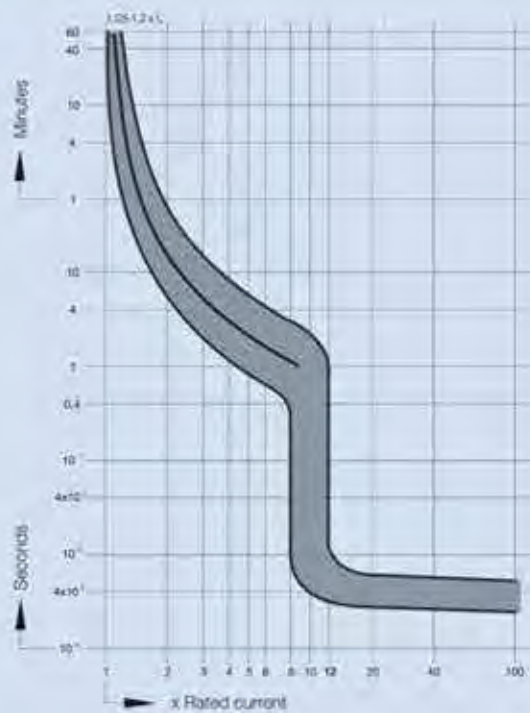

K characteristic $I_n = 13 - 63 \text{ A}$

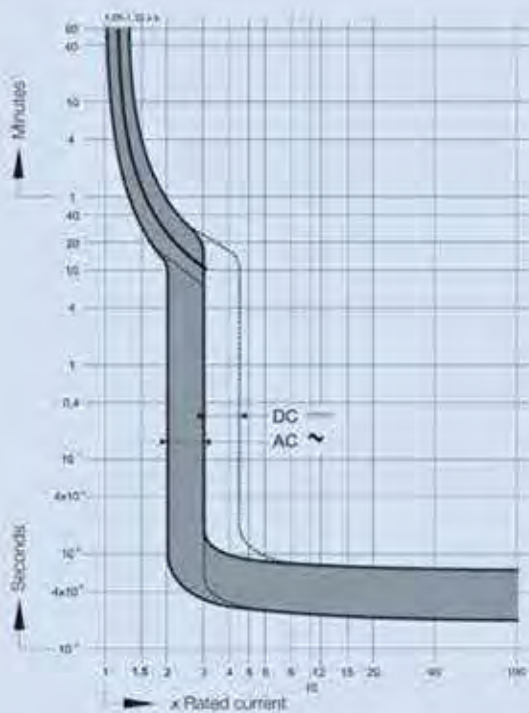

Z characteristic $I_n = 0.3 - 10 \text{ A}$

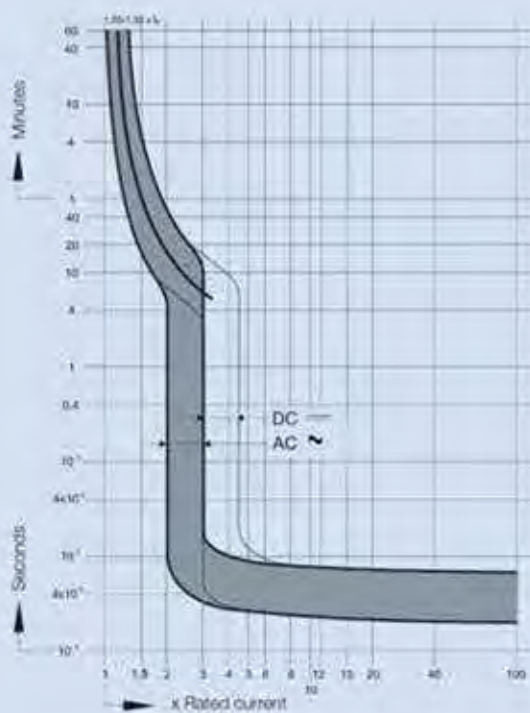

Z characteristic $I_n = 13 - 32 \text{ A}$

Short circuit selectivity

10 kA miniature circuit breakers, T product range Short circuit selectivity to fuses in kA

		Rated current I_n (A)																				
Characteristic		6	6/8	10	10	13	13	16	16	20	20	25	25	32	32	40	40	50	50	63	63	
LV HRC fuse Characteristic gL/gG according to DIN VDE 0636	I_n (A)	25	0.85 0.7 0.7	0.8 0.7 0.8	0.8 0.7 0.8	0.8 0.7 0.6	0.75 0.65 0.6	0.7 0.6 0.55	0.6 0.55 0.5													1.)
	35	1.6 1.3 1.2	1.6 1.3 1.15	1.5 1.25 1.1	1.5 1.2 1.1	1.4 1.2 1.0	1.2 1.1 0.9	1.1 1.0 0.8	0.8 0.7 0.5													
	50	2.4 2.1 1.9	2.35 2.1 1.8	2.3 2.0 1.7	2.3 2.0 1.7	2.2 1.9 1.6	1.6 1.5 1.3	1.5 1.4 1.2	1.3 1.2 1.1	1.2 1.1 1.0												
	63	3.5 2.9 2.5	3.3 2.8 2.4	3.2 2.7 2.4	3.2 2.7 2.3	3.0 2.6 2.3	2.5 2.1 1.8	2.4 2.0 1.8	1.8 1.6 1.4	1.7 1.5 1.3	1.6 1.4 1.2											
	80	5.0 4.1 3.5	4.8 4.0 3.4	4.7 3.9 3.3	4.6 3.9 3.2	4.3 3.6 3.1	3.4 2.8 2.5	3.3 2.8 2.4	2.5 2.1 1.9	2.4 2.0 1.8	2.3 2.0 1.8											
	100	7.6 6.3 5.2	7.3 6.1 4.9	7.1 5.9 4.8	7.0 5.7 4.7	6.5 5.0 4.4	5.1 4.0 3.5	5.0 3.9 3.4	3.5 2.9 2.5	3.3 2.8 2.4	3.1 2.6 2.3											
	125	10 10 8.8	10 10 8.0	10 10 7.7	10 10 7.6	10 8.7 7.1	8.8 6.9 5.7	8.5 6.6 5.6	5.4 4.5 3.6	5.1 4.3 3.6	4.9 4.1 3.5											

1.) There is no more overload selectivity above the step line.

6 kA miniature circuit breakers, S and SL product ranges Short circuit selectivity to fuses in kA

		Rated current I_n (A)													
Characteristic		6	6	10	10	13	13	16	16	20	20	25	25	32	32
LV HRC fuse Characteristic gL/gG according to DIN VDE 0636	I_n (A)	25	0.85 0.7	0.8 0.7	0.8 0.7	0.8 0.7	0.75 0.65	0.7 0.6	0.6 0.55					1.)	
	35	1.6 1.3	1.6 1.3	1.5 1.25	1.5 1.2	1.4 1.2	1.2 1.1	1.1 1.0							
	50	2.4 2.1	2.35 2.1	2.3 2.0	2.3 2.0	2.2 1.9	1.6 1.5	1.5 1.4							
	63	3.5 2.9	3.3 2.8	3.2 2.7	3.2 2.7	3.0 2.6	2.5 2.1	2.4 2.0	1.8 1.6	1.7 1.5	1.6 1.4				
	80	5.0 4.1	4.8 4.0	4.7 3.9	4.6 3.9	4.3 3.6	3.4 2.8	3.3 2.8	2.5 2.1	2.4 2.0	2.3 1.9				
	100					6.0 5.0	5.1 4.0	5.0 3.9							

1.) There is no more overload selectivity above the step line..

Technical Data

Abweichungen in der
Neuübersetzung siehe
Manuskript

Characteristic		B	C
Application		Wiring protection	Wiring protection Device protection
Number of poles		1 and 2 ¹⁾	
Standards		IEC 60898-2, DIN EN 60898-2, VDE 0641-12	
Short circuit withstand rating		6 kA	6 kA
Max. back-up fuse		Fuse according to DIN VDE 0636 100 A operating class gL/gG	
Rated DC voltage L/R = 4 ms		1-pole 125 V, 2-pole 250 V in serial connection of both poles	
Rated current range I_n		1 - 40 A	0,5 - 40 A
Test currents	Thermal not tripping I_1 (A) > 1 h	$1,13 \times I_n$	$1,13 \times I_n$
	Thermal tripping I_2 (A) < 1 h	$1,45 \times I_n$	$1,45 \times I_n$
	Electromagnetic not tripping I_4 (A) > 0.1 s	$4 \times I_n$	$7 \times I_n$
	Electromagnetic tripping I_5 (A) < 0.1 s	$7 \times I_n$	$15 \times I_n$
Reference calibration temperature of the thermal tripping		30 °C + 5 °C Influence of the ambient temperature on the thermal tripping: Decrease of the current values with higher ambient temperature and increase with lower temperatures of approximately 5% per 10 °C difference in temperature	
Ambient temperature		-25 °C to +55 °C	
Storage temperature		-40 °C to +70 °C	
Device depth acc. to DIN 43880		68 mm	
Mechanical endurance		20,000 switching cycles (20,000 ON/20,000 OFF)	
Protection cover		Finger safe and safe to back of hand according to DIN EN 50274/ VDE0660-514, BGV A3	
Degree of protection acc. to EN 60529 / IEC 60529		IP 20	
Installation position		any	
Mounting		DIN-rail according to DIN EN 60715 35 mm	
Lockability		The handle can be secured against manual switching in the on and off position by a lead seal	
Climatic resistance		Humid heat constant according to DIN IEC 60068-2-78 Humid heat cycle according to DIN EN 60068-2-30	
Vibration resistance		> 15 g according to DIN EN 60068-2-59 during a load with I_n	
Resistance to mechanical shocks		25g 11ms	

Type of conductor *)	Conductor cross sections product range DC			
	Box terminal bottom		Box terminal top	
	max.	min.	max.	min.
Single wire	35 mm ²	0,5 mm ²	25 mm ²	0,5 mm ²
Multiple wire	35 mm ²	1,5 mm ²	25 mm ²	1,5 mm ²
Stranded wire	25 mm ²	1 mm ²	16 mm ²	1 mm ²
Stranded wire with ferrule	16 mm ²	0,5 mm ²	16 mm ²	0,5 mm ²
Busbar cable lug	Up to 3 mm thickness		Up to 3 mm thickness	
Combined, connector and busbar or cable lug	Up to 35 mm ² and up to 2 mm thickness		Up to 25 mm ² and up to 2 mm thickness	
Torque	max. 2,5 Nm			

*) Stripped length 12 - 14 mm

Operating status display



Miniature circuit breakers
with switched neutral-
Width merely a part unit!

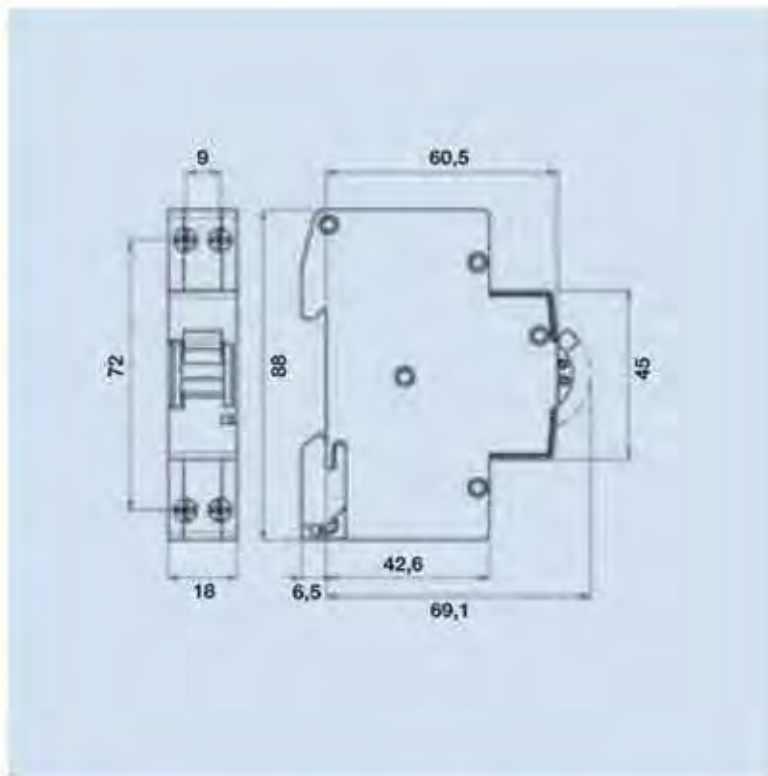

Rated current I_n A	Characteristic		Weight g/each	Packing unit
	B Article no.	C Article no.		

1-pole, 1 module				
10	B10N8R	C10N8R	101	12
13	B13N8R	C13N8R	101	12
16	B16N8R	C16N8R	101	12
20	B20N8R	C20N8R	101	12
25	B25N8R	C25N8R	101	12
32	B32N8R	C32N8R	101	12





Auxiliary contact					
Module	Type of contact	Contacts	Article no.	Weight g/each	Packing unit
1/2	1 auxiliary contact	1NO	HL10	35	20
1/2	2 auxiliary contacts	1NO + 1NC	HL11	40	20
1/2	2 auxiliary contacts	1NO + 1NC	HL11L*	40	20
1/2	3 auxiliary contacts	1NO + 2NC	HL12	45	20
1/2	3 auxiliary contacts	2NO + 1NC	HL21	45	20

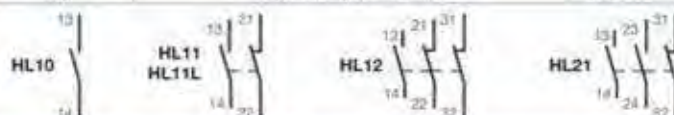

* Mounting on the left

Auxiliary contact					
Module	Type of contact	Contacts	Article no.	Weight g/each	Packing unit
1/2	1 auxiliary contact	1 CO contact	HWL10	40	20
1/2	2 auxiliary contacts	2 CO contact	HWL20	50	20



Auxiliary contact with signal contact					
Module	Type of contact	Contacts	Article no.	Weight g/each	Packing unit
1/2	1 signal contact / 1 auxiliary contact	2 CO contact	HSL11	50	20
1/2	1 signal contact / 1 auxiliary contact	2 CO contact	HSL11L*	50	20
1/2	1 signal contact	1 CO contact	HSL10	40	20

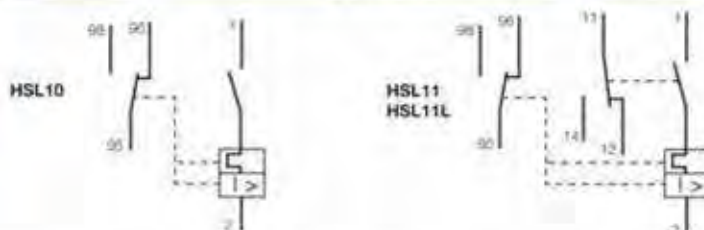

* Mounting on the left

The signal contact and the auxiliary contact are each fitted with a floating CO contact contact. Both contacts have trip-free mechanisms, i.e. manipulating the contact positions from outside is not possible. The signal contact only indicates when the main device is overloaded or short circuited but not when switched off by hand. The auxiliary contact clearly shows the switched condition of the main device i.e. when overloaded or short circuited and when switched off manually.

Technical Data		HL10, HL11/L, HL12, HL21	HWL10, HWL20, HSL10, HSL11/L
Standards		IEC 60947-5-1, DIN EN 60947-5-1, VDE 0660-200	
Rated voltage		230 V~	
Conventional thermal current in enclosure		I _g e 16 A	
Rated operating currents I _e	Usage category AC-15	10 A / 230 V	4.8 A / 230 V
	Usage category AC-15	16 A / 110 V	9.6 A / 120 V
	Usage category DC-13	1 A / 250 V	1.8 A / 250 V
	Usage category DC-13	3 A / 125 V	3.5 A / 125 V
Minimum switching capacity		0.05 VA at 6 V UC	

Conductor cross sections for all auxiliary contacts			
Type of conductor *)		max.	min.
Single wire		0.5 mm ²	2.5 mm ²
Stranded wire		0.5 mm ²	1.5 mm ²
Stranded wire with ferrule		0.5 mm ²	1.5 mm ²

*) Stripped length 8 - 9 mm

Busbars

for S, SL and T miniature circuit breakers, MA motor circuit breakers and residual current circuit breakers

Cross section (mm ²)	Busbar current Start of busbar/ End of busbar/	Number of poles	Article no.	Weight g/each	Packing unit
----------------------------------	--	-----------------	-------------	---------------	--------------



Busbars fork type						
3-phase						
10	63	6	G31006	37	25	
10	63/100	9	G31009	60	25	
10	63/100	12	G31012	84	25	
16	80	6	G31606	52	20	
16	80/130	9	G31609	87	20	
16	80/130	12	G31612	119	20	



Busbars fork type						
3-phase for left-hand RCB installation in the distribution board (N omitted)						
10	63	11	G31011S	82	25	
16	80	11	G31611S	117	20	
3-phase for right-hand RCB installation in the distribution unit						
16	80	11	G31611	108	20	



ABL SURSUM miniature circuit breakers according to UL508 and CSA-22.2 no. 14

Not all ULs are the same!

A large part of the miniature circuit breakers available on the market only comply with the UL1077 standard. This means they are only allowed to be manufactured by a UL-certified switchgear manufacturer (UL panel shop).

The miniature circuit breaker is merely recognised i.e. the finished switchgear system must additionally be approved by a UL inspector.

It must not be switched on or off under load!

ABL SURSUM miniature circuit breakers are listed in the USA and Canada according to UL508 and every approved electrical installation company or switchgear manufacturer is permitted to install our miniature circuit breakers. Furthermore, switching-on and off under load is permitted. ("motor disconnecting means").

Even group fusing in the European way is tested and approved for the miniature circuit breakers listed under UL 508. Thus, a considerably wider field of application can be covered!



European-type of busbar wiring tested and approved for UL



UL-approved accessories

Miniature Circuit Breaker

1-pole to 3-pole
1-pole + N
3-pole + N

Characteristic:
B, C, D, E, G and Z

Rated currents:
0,3 to 60A



Lock-off/
Lock-on device



Shunt trip



Auxiliary contact

according to UL 508 and CSA-22.2 No.14

B, C und D also acc. to IEC 60898-1, DIN EN 60898-1, VDE 0641-11

This product range differentiates between:

- Standard products for normal market applications (shown in the table in bold – delivery time approx. 2 weeks)
- Exclusive products for sector-specific applications (shown in the table in normal print – longer delivery time)



Rated current I_n A	Characteristic						Weight g/each	Packing unit
	B	C	D	G	E	Z		

2-pole								
Rated current I_n A	B	C	D	G	E	Z	Weight g/each	Packing unit
0.3		2C03UM	2D03UM	2G03UM	2E03UM	2Z03UM	300	6
0.5		2C05UM	2D05UM	2G05UM	2E05UM	2Z05UM	300	6
0.75		2C075UM	2D075UM		2E075UM	2Z075UM	300	6
0.8				2G08UM				
1	2B1UM	2C1UM	2D1UM	2G1UM	2E1UM	2Z1UM	300	6
1.6		2C1.6UM	2D1.6UM	2G1.6UM	2E1.6UM	2Z1.6UM	300	6
2		2C2UM	2D2UM	2G2UM	2E2UM	2Z2UM	300	6
2.5		2C2.5UM	2D2.5UM	2G2.5UM	2E2.5UM	2Z2.5UM	300	6
3	2B3UM	2C3UM	2D3UM	2G3UM	2E3UM	2Z3UM	300	6
3.5		2C3.5UM	2D3.5UM	2G3.5UM	2E3.5UM	2Z3.5UM	300	6
4	2B4UM	2C4UM	2D4UM	2G4UM	2E4UM	2Z4UM	300	6
5	2B5UM	2C5UM	2D5UM	2G5UM	2E5UM	2Z5UM	300	6
6	2B6UM	2C6UM	2D6UM	2G6UM	2E6UM	2Z6UM	300	6
8		2C8UM	2D8UM	2G8UM	2E8UM	2Z8UM	300	6
10	2B10UM	2C10UM	2D10UM	2G10UM	2E10UM	2Z10UM	300	6
12				2G12UM		2Z12UM		
13	2B13UM	2C13UM	2D13UM	2G13UM	2E13UM	2Z13UM	300	6
15	2B15UM	2C15UM	2D15UM	2G15UM	2E15UM	2Z15UM		
16	2B16UM	2C16UM	2D16UM	2G16UM	2E16UM	2Z16UM	300	6
20	2B20UM	2C20UM	2D20UM	2G20UM	2E20UM	2Z20UM	300	6
25	2B25UM	2C25UM	2D25UM	2G25UM	2E25UM	2Z25UM	300	6
30	2B30UM	2C30UM	2D30UM	2G30UM	2E30UM	2Z30UM		
32	2B32UM	2C32UM	2D32UM	2G32UM	2E32UM	2Z32UM	300	6
40	2B40UM	2C40UM	2D40UM	2G40UM	2E40UM	2Z40UM	300	6
50	2B50UM	2C50UM	2D50UM	2G50UM	2E50UM	2Z50UM	300	6
60	2B60UM	2C60UM	2D60UM	2G60UM	2E60UM		300	6
63	2B63UM	2C63UM	2D63UM	2G63UM	2E63UM		300	6



Auxiliary contact

Module	Type of contact	Contacts	Article no.	Weight g/each	Packing unit
1/2	1 auxiliary contact	1NO	H10UM	35	10
1/2	2 auxiliary contacts	1NO + 1NC	H11UM	40	10
1/2	3 auxiliary contacts	1NO + 2NC	H12UM	45	10
1/2	3 auxiliary contacts	2NO + 1NC	H21UM	45	10

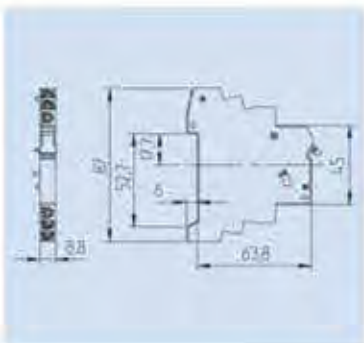

Standards	Acc. to IEC 60947-5-1, DIN EN 60947-5-1, VDE 0660-200, UL 508	
Rated operating currents	10 A / 240 V AC 3 A / 110 V DC 1 A / 220 V DC	
Minimum contact load	1 mA at 24 V DC	
Type of conductor *)	Conductor cross sections	
	min.	max.
	Single wire	2.5 mm ²
	Stranded wire	1.5 mm ²
Stranded wire with ferrule	1.5 mm ²	
Torque	max: 0.8 Nm	

*) Stripped length 8 - 9 mm



Shunt trip

Module	Rated operating voltage	max. operating current at U _n (t < 10 ms)	Article no.	Weight g/each	Packing unit
1	12 V UC	1.3 A	FA12UM	105	5
1	24 V UC	0.6 A	FA24UM	105	5
1	48 - 74 V UC	0.2 A	FA48UM	105	5
1	110 - 240 V UC, 415 V AC	0.25 A at 110 V	FA110UM	105	5
		0.5 A at 240 V			
		0.8 A at 415 V			

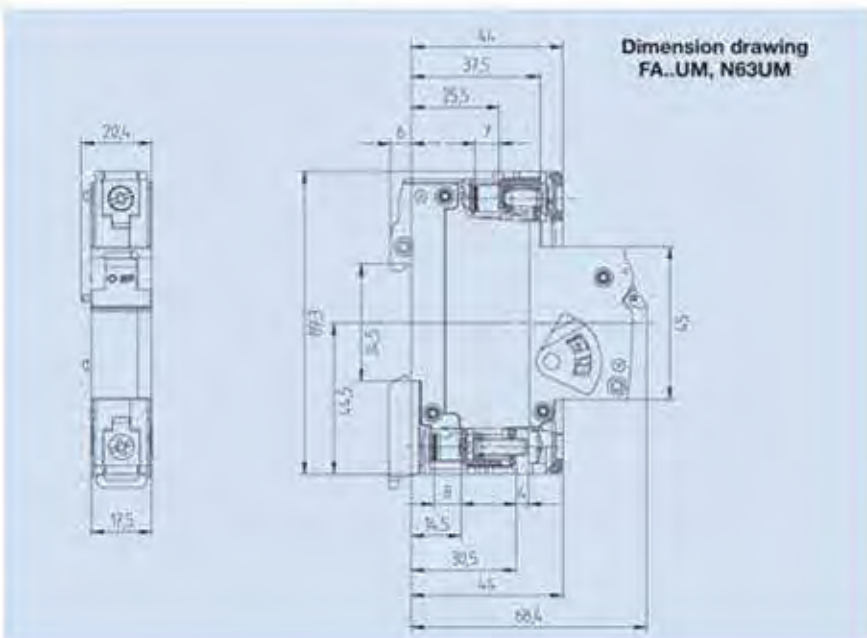

Lock-off/Lock-on device

Article no.	Weight g/each	Packing unit
EASS	2	10

for S, SL and T miniature circuit breakers,
 MA motor circuit breakers and residual current circuit breakers,
 also useable for UI and CSA miniature circuit breakers

Cross section (mm ²)	Busbar current Start of busbar/ Middle infeed	Modules/ Phases	Article no.	Weight g/each	Packing unit	Suitable end cap Article no.
----------------------------------	---	--------------------	-------------	------------------	-----------------	------------------------------------



Busbars fork type

1-phase

12	65/110	56	SB16010	250	50	
----	--------	----	----------------	-----	----	--

1-phase 1-pole circuit breaker + auxiliary contact

24	90/150	37/1	SDO.124	200	50	
----	--------	------	----------------	-----	----	--

2-phase and 1-phase + N

10	63/100	28/2	SB26010	390	20	SB.A5
----	--------	------	----------------	-----	----	-------

2-phase 2-pole circuit breaker + auxiliary contact

16	80/130	22/2	SB26216	310	20	SB.A2
----	--------	------	----------------	-----	----	-------

3-phase

10	63/100	4/3	SB31210	84	25	SB.A1
----	--------	-----	----------------	----	----	-------

10	63/100	19/3	SB36010	420	20	SB.A1
----	--------	------	----------------	-----	----	-------

16	80/130	19/3	SB36016	675	20	SB.A2
----	--------	------	----------------	-----	----	-------

3-phase 3-pole circuit breaker + auxiliary contact

16	80/130	16/3	SB36316	630	20	SB.A2
----	--------	------	----------------	-----	----	-------

3-phase 1-pole circuit breaker + auxiliary contact

16	80/130	36/1	SDO.316	500	20	SB.A2
----	--------	------	----------------	-----	----	-------

4-phase and 3-phase + N

16	80/130	14/4	SB46016	835	15	SB.A3
----	--------	------	----------------	-----	----	-------



End caps for busbars

for busbars article no.	Article no.	Weight g/each	Packing unit
SB31210, SB36010	SB.A1	0.8	10
SB36016, SB36316, SDO.316, SB718U, SB26216	SB.A2	1	10
SB46016	SB.A3	1.1	10
SB26010	SB.A5	0.8	10

Characteristic	B	C	D	E	G	Z
Application	Wiring protection	Wiring protection Device protection	Wiring protection Power circuits Transformers Motors	Wiring protection Power circuits Transformers Motors	Wiring protection Device protection	Wiring protection Semiconductor protection High impedance
Number of poles	1 - 3; 1 + N; 3 + N					
Standards	IEC 60898-1, DIN EN 60898-1, VDE 0641-11, UL 508, CSA-22.2 No.14					
Short circuit withstand rating	see data sheet for use in the USA, Canada and Europe					
Current limiting class	3	3				
Max. back-up fuse	see data sheet for use in the USA, Canada and Europe					
Rated voltage AC	277 / 480 V					
Rated voltage DC L/R = 4 ms	1-pole 42 V and 2-poles 80 V in serial connection of both poles (up to 25-A rated current)					
	1-pole 24 V and 2-poles 60 V in serial connection of both poles (30 A - 60 A rated current)					
Rated current range	6 - 60 A	0.3 - 60 A	0.3 - 60 A	0.3 - 60 A	0.3 - 60 A	0.3 - 32 A
Test currents	Thermal not tripping I_1 (A) > 1 h	$1.13 \times I_n$	$1.13 \times I_n$	$1.13 \times I_n$	$1.05 \times I_n$	$1.05 \times I_n$
	Thermal tripping I_2 (A) < 1 h	$1.45 \times I_n$	$1.45 \times I_n$	$1.45 \times I_n$	$1.35 \times I_n$	$1.35 \times I_n$
	Electromagnetic not tripping I_3 (A) > 0.1 s	$3 \times I_n$	$5 \times I_n$	$10 \times I_n$	$14 \times I_n$	$8 \times I_n$
	Electromagnetic tripping I_4 (A) < 0.1 s	$5 \times I_n$	$10 \times I_n$	$16 \times I_n$	$18 \times I_n$	$10 \times I_n$
Reference calibration temperature of the thermal tripping	30° C + 5° C			20° C + 5° C		
	Influence of the ambient temperature on the thermal release: Decrease of the current values with higher ambient temperature and increase with lower temperatures of approximately 5% per 10°C difference in temperature					
Frequency range of the electromagnetic trip	16 ² / ₃ to 60 Hz With higher frequencies, the electromagnetic tripping values increase by approximately a factor of 1.1 at 100 Hz; 1.2 at 200 Hz; 1.3 at 300 Hz; 1.4 at 400 Hz; 1.5 for DC					
Ambient temperature	-25 °C to +55 °C					
Storage temperature	-40 °C to +70 °C					
Device depth according to DIN 43880	68 mm					
Mechanical endurance	20,000 switching cycles (20,000 ON / 20,000 OFF)					
Protection cover	Finger safe and safe to back of hand according to DIN EN 50274/ VDE0660-514, BGV A3					
Insulation group acc. to DIN/VDE 0110	C at 250 V AC B at 400 V AC					
Degree of protection acc. to EN/IEC 60529	IP 20					
Installation position	any					
Mounting	DIN-rail according to DIN EN 60715 35 mm					
Lockability	The handle can be secured against manual switching in the on and off position by a lead seal					
Climatic resistance	Humid heat constant according to DIN EN 60068-2-78 Humid heat cycle according to DIN EN 60068-2-30					
Vibration resistance	> according to DIN EN 60068-2-59 during a load with I_1					
Resistance to mechanical shocks	25g 11ms					

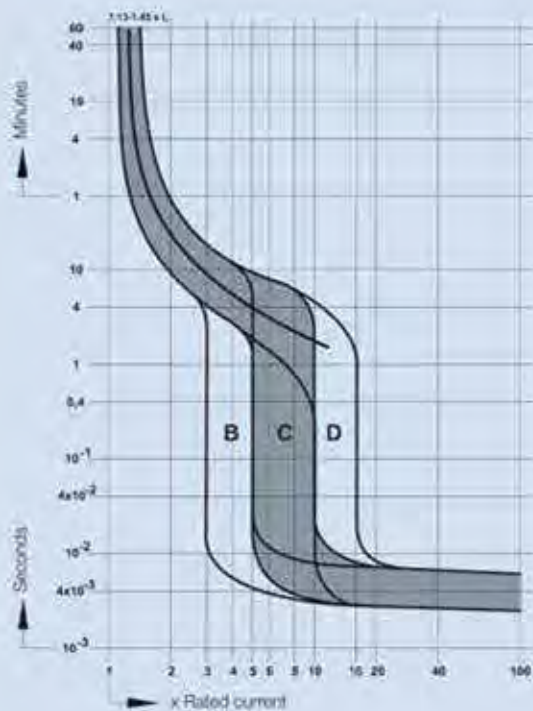

B, C and D characteristic $I_n = 0.3 - 10 \text{ A}$
UL

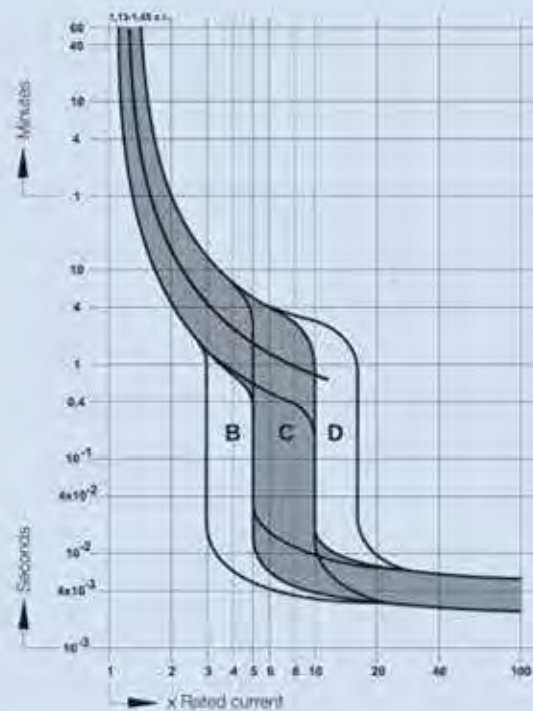

B, C and D characteristic $I_n = 13 - 60 \text{ A}$
UL

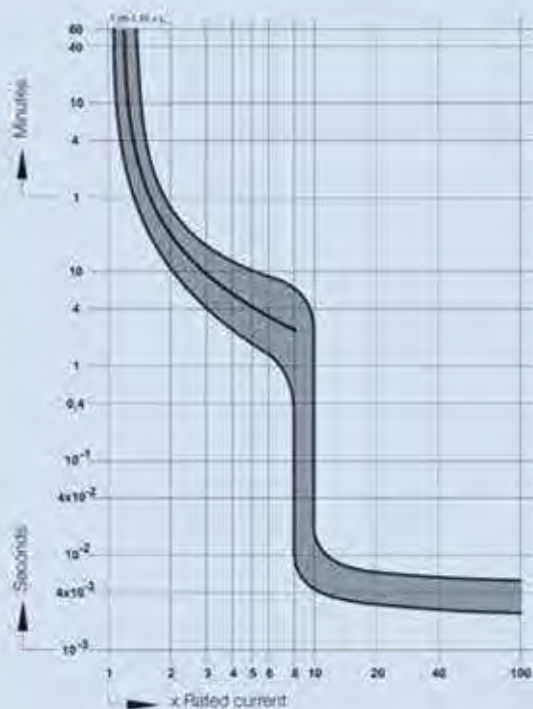

G characteristic $I_n = 0.3 - 10 \text{ A}$
UL

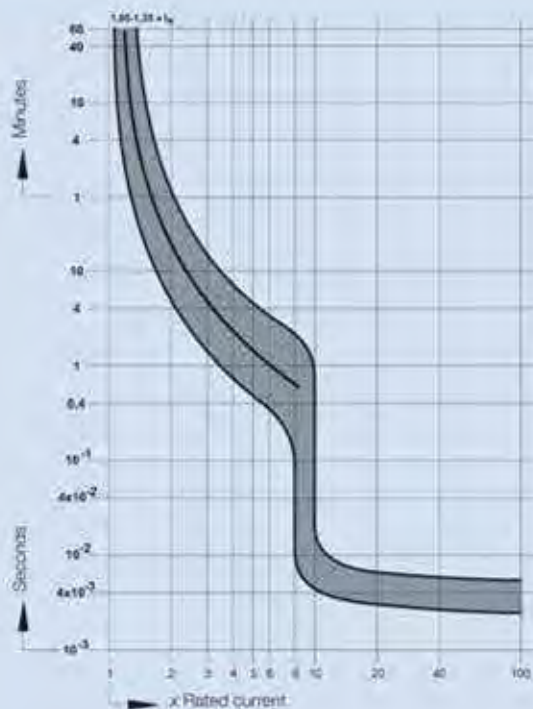

G characteristic $I_n = 12 - 60 \text{ A}$
UL

Rated voltage: 220/380 V AC, 220 V DC,
E 27 thread



L characteristic acc. to DIN VDE 0641-100

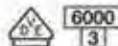

Rated current I _n A	Thermal test current		Trip		Article no.	Weight g/each	Packing unit
	Small I _t A (>1 h)	Large I _t A (<1 h)	Electromagnetic 50 Hz	Not tripping I _t A (>0,1 s)			
6	9	11.4	21.6	31.5	SPL6-0	100	10
10	15	19	38	52.5	SPL-10	100	10
16	22.4	28	53.8	78.4	SPL-16	100	10
20	28	35	67.2	98	SPL-20	100	10
25	35	43.75	84	123	SPL-25	100	10

Fuse switch disconnectors

Fuse switch disconnectors for D0 fuse links
IEC 60269-3-1 (I) / DIN VDE 0636-301
DIN VDE 0660 part 107/ EN 60947-3/ IEC 60947-3 DIN VDE 0638

- 1, 2 and 3-pole type
- For D02 fuse links, DIN VDE 0636-301 adapter sleeves
- Reduction insert for D01 fuse links
- Snap-on mounting for DIN EN 60715 DIN-rails
- Captive fuse carrier
- Changing the fuse only after complete break in the circuit by opening the switching knobs
- User-dependent fuse contacting
- Finger safety even when switching knobs are open
- Double-function terminal: Cu 1.5 - 35 mm² (f, f + AE), 3,0 - 4,0 Nm

The D0 fuse switch disconnector combines the advantages of fuses with a high degree of safety and user convenience. Changing the fuse is only possible in a de-energised state. Adapting to the fuse size is carried out in the captive fuse carrier by means of a standard adapter sleeve. A screw cap is not necessary.



D02 safety circuit breakers

No. of poles	Article no.	Weight g/each	Packing unit
1	SL14.01	140	3
2	SL24.01	278	2
3	SL34.01	420	1

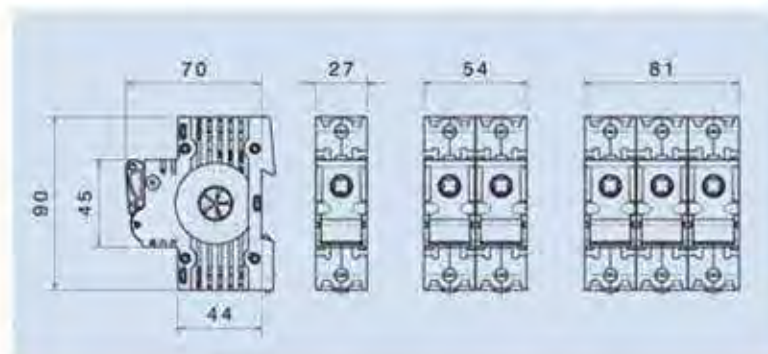

Reduction insert for D01 fuses

Article no.	Weight g/each	Packing unit
SLAD	1	20

Technical Data	
Size	D02
Current type	AC (50 Hz), DC
Max. rated operating voltage (U _e)	400 V AC, 130 V DC
Rated insulation voltage (U _i)	500 V
Rated impulse voltage strength (U _{imp})	6 kV
Rated operating current (I _c)	63 A, 63 A
Utilisation categories IEC 60947-3 all pole descriptions 1-pole 2-pole	AC-22 B 400 V 63 A DC-22 B 65 V 63 A DC-22 B 130 V 63 A
Utilisation categories DIN VDE 0638	AC-22 400 V 63 A
Conditional rated short-circuit current*	50 kA (AC), 8 kA (DC)
For fuse links with power losses per phase up to	5.5 W

* Type-tested with fuse links
Operating class: gL/gG 400 V AC / 250 V DC – 63 A bzw. 440 V AC – 35 A

The electronic life-saver

It can happen very quickly: Thoughtlessly touching a current-carrying cable; a faulty connecting cable; or a device fault. Happy are those who have protected their electrical system with the right RCCB.

In the event of damage, it is activated within a fraction of a second, breaks the circuit and thus possibly saves lives.

In this way, everyday exposure to current gets considerably safer. For new installations and extensive renovations of commercial and private electrical systems, the use of RCCBs is mandatory according to VDE 0100-410 since June 2007 anyway. This also refers to all outdoor electrical systems and electric circuits.

Our product range offers you the right RCCB solution for every field of application because – in addition to devices of type A (sensitive to pulsating currents) and type B (sensitive to universal current) for the German market – we can also deliver devices of type AC (sensitive to alternating current – not approved for Germany) for export.



Areas of application

Power supplies of residential and single-purpose buildings as well as industrial facilities with TN-S and TN-C-S networks.

In IT networks, RCCBs of the RP range for switch-off in case of a second fault can be provided for.

The use in TN-C networks and for protecting systems in which electronic equipment might cause DC residual currents or residual currents with frequencies of $\neq 50$ Hz is excluded.

Accessories

- RH11 auxiliary contact
- Label sheet
- Free pictoplan labelling software (see page 25)

Seite

This product range differentiates between:

- Standard products for normal market applications (shown in the table in bold – delivery time approx. 2 weeks)
- Exclusive products for sector-specific applications (shown in the table in normal print – longer delivery time)

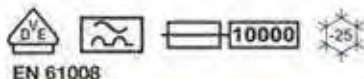

Rated resid. current $I_{\Delta n}$ mA	Rated current I_n A	Surge current strength > A	Max. back-up fuse A	Modules	Article no.	Weight g/each	Packing unit
--	-----------------------------	-------------------------------	------------------------	---------	-------------	------------------	--------------



2-pole							
10	16	250	50	2	RP2101	270	1
30	25	250	80	2	RP2203	270	1
300	25		80	2	RP2230	270	1
30	40	250	80	2	RP2303	270	1
300	40	250	80	2	RP2330	270	1
30	63	250	80	2	RP2403	270	1
300	63	250	80	2	RP2430	270	1
500	63	250	80	2	RP2450	270	1



4-pole							
30	25	250	80	4	RP4203	450	1
300	25	250	80	4	RP4230	420	1
500	25	250	80	4	RP4250	420	1
30	40	250	80	4	RP4303	450	1
300	40	250	80	4	RP4330	420	1
500	40	250	80	4	RP4350	420	1
30	63	250	100	4	RP4403	450	1
300	63	250	100	4	RP4430	420	1
500	63	250	100	4	RP4450	420	1
30	80	250	125	4	RP4503	460	1
300	80	250	125	4	RP4530	430	1
500	80	250	125	4	RP4550	430	1
30	100	250	125	4	RP4603	460	1
300	100	250	125	4	RP4630	430	1
500	100	250	125	4	RP4650	430	1
30	125	250	125	4	RP4703	460	1
300	125	250	125	4	RP4730	430	1
500	125	250	125	4	RP4750	430	1

Selective switch-off

Function

Selective RCCB independent of the mains voltage for realising the protective measure "protection through automatic power-supply cut-off", in compliance with the requirements of VDE 0100 part 410 or corresponding international construction regulations.

The selective RCCB requires a longer residual-current flow time for tripping than an undelayed RCCB. This allows for selective switch-off with two switches connected in series in systems with sequenced distributions, i.e. with RCCBs connected in series (e.g.: 0.3 A S and 0.03 A) only that RCCB trips – in the event of fault – in whose immediate downstream system part the earth fault occurred. Due to their long switch-off times and high rated residual currents, selective RCCBs only provide protection against fire and in case of indirect contact (fault protection). Protection in case of direct touching (operator protection) is therefore not possible.

Characteristics

- 4-pole
- Large range of products with
 - Rated currents from 16 A to 125 A
 - Rated residual currents 0.1 A to 0.5 A
- Tripping independent of supply and auxiliary voltage
- Sensitive to AC and pulsating DC residual currents (type A)
- Sensitive to AC residual currents (type AC)
- High short-circuit strength
- Double-sided two-tier terminals for large conductor cross-section and busbar
- Switch-position display
- Viewing window for labels
- Multi-functional switching knob with three functions:
 - **On** (top position)
 - **Off** (bottom position)
 - Display **"tripped"** (centre position)
 If the RCCB trips due to a fault, the switching knob stays in the centre position

Type of mounting

- Quick mounting on DIN-rail according to EN 50022 in any standard distribution
- Any mounting position

Areas of application

Main distributors in extended electricity supply systems with TN-S and TN-C-S systems, e.g. for

- Camping sites
- Marinas
- Allotment colonies
- Fairgrounds
- etc.

Here, selective RCCBs mostly protect the cables from the main distribution to the sub-distributions.

The use in TN-C networks and in systems in which electronic equipment might cause smooth DC residual currents or residual currents with frequencies of $\neq 50$ Hz is excluded.

Notes

To ensure the selectivity of the RCCB, the rated residual current of the RA4xxxS must be selected at least one level higher than that of the undelayed switch connected downstream.

Accessories

- RH11 auxiliary contact
- Label sheet
- Free pictoplan labelling software (see page 25)

Seite

Exclusive products for sector-specific uses – please note longer delivery periods!

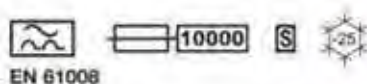

Rated resid. current $I_{\Delta n}$ mA	Rated current I_n A	Surge current strength > A	Max. back-up fuse A	Modules	Article no.	Weight g/each	Packing unit
--	-----------------------------	-------------------------------	------------------------	---------	-------------	---------------	--------------



4-pole, selective switch-off							
300	40	5,000	80	4	RP4330S	430	1
300	63	5,000	100	4	RP4430S	450	1
300	100	5,000	125	4	RP4630S	460	1
300	125	5,000	125	4	RP4730S	460	1

Characteristics

- 4-pole
- All-current-sensitive for fault currents with frequencies and mixed frequencies from 0 to 1 MHz
- Large range of products with
 - Rated currents from 16 A to 125 A
 - Rated residual currents 0.03 A to 0.5 A
- Small size for all rated currents
- VDE test mark approved in compliance with VDE 0664 T10 / VDE 0664 T 100 E
- Very unsusceptible to transient drainage and fault currents, due to delayed tripping response
- Electromagnetic compatibility in compliance with VDE 0664 part 30 and VDE 0839 part 6-2 (interference resistance for industrial use)
- High availability, also of the voltage-dependent detection of smooth DC residual current and AC residual currents with frequencies \neq 50/60 Hz, due to full operability with mains voltages above 30 V, applied to any 2 current paths only
- Tripping at fault currents of type A, independent of mains voltage
- High short-circuit strength
- Double-sided two-tier terminals for large conductor cross-section and busbar connection
- Switch-position display
- Multi-functional switching knob with three functions:
 - **On** (top position)
 - **Off** (bottom position)
 - Display **"tripped"** (centre position)
 If the RCCB trips due to a fault, the switching knob stays in the centre position
- Viewing window for labels

Type of mounting

- Quick mounting on DIN rail in accordance with EN 50022 in any standard distribution
- Any mounting position
- Infeed direction from above (N, 1, 3, 5)

Areas of application

Commercial and industrial installations with TN-S and TN-C-S systems where power electronics equipment without galvanic mains separation is used, such as:

- Frequency converters
- UPS systems
- Switched-mode power supplies
- High-frequency converters
- On-site power supply distributors
- Photovoltaic systems

Note

Not intended for use in DC power supplies!

Accessories

- RH11 auxiliary contact
- Label sheet
- Free pictoplan labelling software (see page 25)

RA4xxx 30 mA

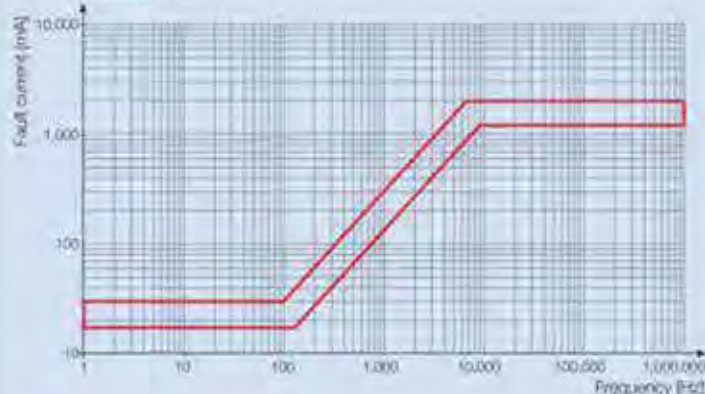

RA4xxx 300 mA

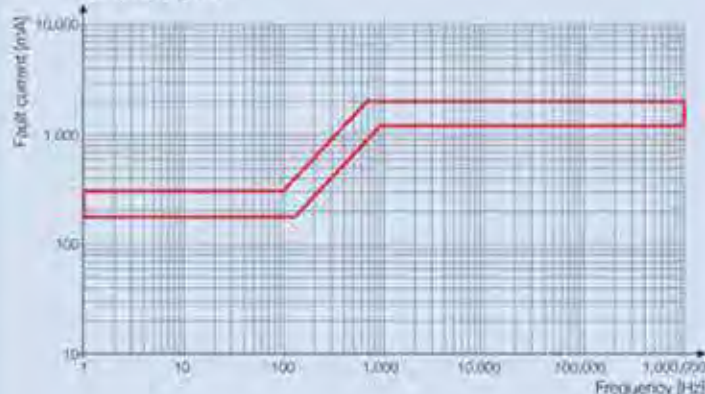

RA4xxx 500 mA

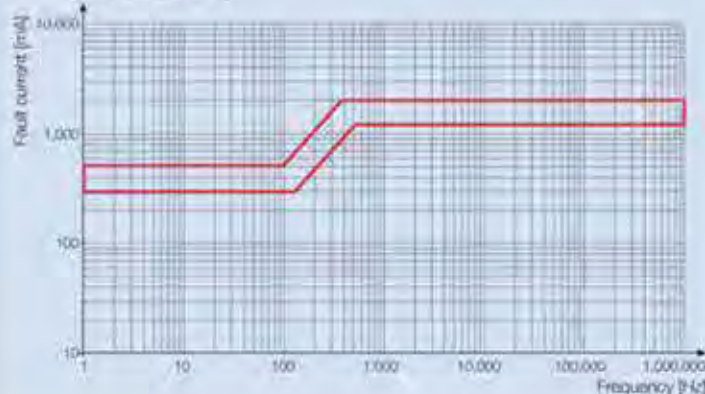

Function

Selective, all-current-sensitive RCCBs for realising the protective measure “protection through automatic power supply cutoff” in systems with electronic equipment, in compliance with the requirements of VDE 0100 part 410, VDE 0160, and corresponding international construction regulations.

The selective RCCB requires a longer residual-current flow time for tripping than an undelayed RCCB. This allows for selective switch-off when two switches are connected in series in systems with staged distributions i.e. in case of RCCBs connected in series with, for example, $I_{\Delta n} = 0.5 \text{ A S}$ and $I_{\Delta n} = 0.3 \text{ A}$, in case of failure even with a high fault current, only the RCCB will trip, in the downstream system part of which the earth fault occurred. Due to their long switch-off times and high rated residual currents, selective RCCBs provide protection against fire and indirect touching (fault protection) only. Protection in case of direct touching (operator protection) is therefore not possible.

Apart from the voltage-independent detection of AC and pulsating DC residual currents, all units of the RA4xxxS product line are also able to detect smooth DC residual currents. They therefore correspond to type B acc. to IEC TR 60755.

Beyond this requirement, the RA4xxxS seamlessly detects fault currents of all frequencies up to 100 kHz.

For the all-current-sensitive function, the detection electronics require an auxiliary voltage which is supplied internally by the mains conductors. In the event of failure, the auxiliary voltage can drop to 30 V and must be applied only between any two current paths. With its low requirements concerning the auxiliary voltage and its large frequency range of fault current detection, the RA4xxxS clearly exceeds the requirements of the first construction standard for RCCBs type B, VDE 0664-100E.

The frequency response of the RA4xxxS tripping current is designed such that fault currents with high frequencies, e.g. in the range of clock frequencies of frequency converters, are detected with strongly reduced sensitivity. This largely prevents false tripping through drainage currents. However, even with residual currents of these frequencies, protection in case of indirect contact (fault protection) in compliance with VDE 0100-410 is realisable. The defined tripping threshold for all frequencies up to 100 kHz always enables the definition of a maximum earth resistance, so that in case of failure any inadmissibly high contact voltage will be switched off fast.

Characteristics

- 4-pole
- Selectively to all undelayed RCCBs (type AC, A, or B) for fault currents of all frequencies in the detection range and for fault currents of type B.
- Large range of products with
 - Rated currents from 16 A to 125 A
 - Rated residual currents 0.3 A to 0.5 A
- Small size for all rated currents
- For systems with high drainage currents in the frequency range > 1 kHz
- Very unsusceptible to transient drainage and fault currents due to high surge current strength
- Electromagnetic compatibility in compliance with VDE 0664 part 30 and VDE 0839 part 6-2 (interference resistance for industrial use)
- High availability, also of the voltage-dependent detection of smooth DC residual current and AC residual currents with frequencies $\neq 50/60 \text{ Hz}$, due to full operability with mains voltages above 30 V, applied to any 2 current paths only.
- Tripping at fault currents of type A, independent of mains voltage
- High short-circuit strength
- Double-sided two-tier terminals for large conductor cross-sections and busbar connection
- Switch-position display
- Viewing window for labels
- Multi-functional switching knob with three functions:
 - **On** (top position)
 - **Off** (bottom position)
 - Display **“tripped”** (centre position)
If the RCCB trips due to a fault, the switching knob stays in the centre position
- Viewing window for labels

Approved
as an export
version only!

RCCB – sensitive to alternating current Type AC

RW product line, undelayed switch-off
export version – not approved in Germany
Technical data

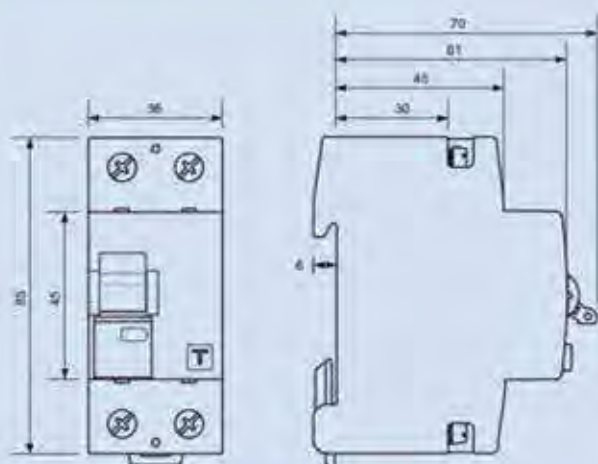

RW product range, 2-pole

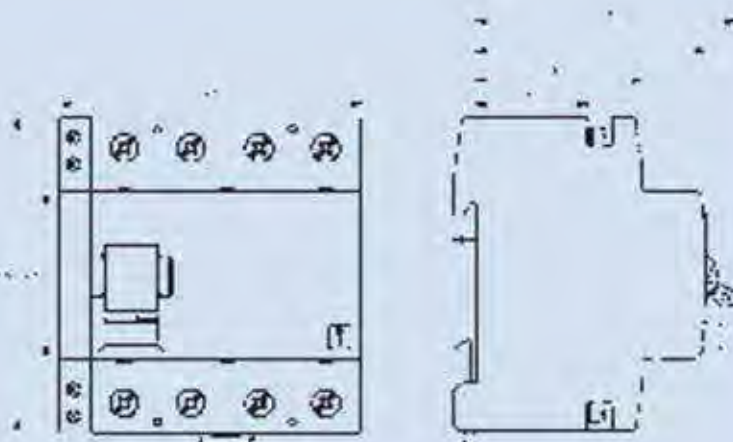

RW product range, 4-pole

Function

RCCB independent of the supply voltage for realising the protective measure "protection through automatic power supply cutoff", in compliance with the requirements of international construction regulations.

Characteristics

- 2-pole or 4-pole
- Large range of products with
 - Rated currents from 16 A to 125 A
 - Rated residual currents 0.03 A to 0.5 A
- Tripping independent of supply and auxiliary voltage
- Sensitive to AC residual currents (type AC)
- High short-circuit strength
- Double-sided two-tier terminals for large conductor cross-section and busbar
- Switch-position display
- Viewing window for labels
- Multi-functional switching knob with three functions:
 - **On** (top position)
 - **Off** (bottom position)
 - Display **"tripped"** (centre position)
 If the RCCB trips due to a fault, the switching knob stays in the centre position



RW product range, 2-pole



RW product range, 4-pole
25-80 A

Approved
as an export
version only!

RCCB – sensitive to alternating current Type AC

Undelayed switch-off
Export version – not approved in Germany

This product range differentiates between:

- Standard products for normal market applications (**shown in the table in bold – delivery time approx. 2 weeks**)
- Exclusive products for sector-specific applications (shown in the table in normal print – longer delivery time)

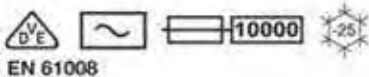

EN 61008



Rated-resid. current $I_{\Delta n}$ mA	Rated current I_n A	Surge current strength > A	Max. back-up fuse A	Modules	Article no.	Weight g/each	Packing unit
--	-----------------------------	-------------------------------	------------------------	---------	-------------	------------------	--------------

4-pole, undelayed switch-off							
30	16	250	80	4	RW4103	450	1
100	16	250	80	4	RW4110	450	1
300	16	250	80	4	RW4130	450	1
30	25	250	80	4	RW4203	450	1
100	25	250	80	4	RW4210	450	1
300	25	250	80	4	RW4230	450	1
30	40	250	80	4	RW4303	450	1
100	40	250	80	4	RW4310	450	1
300	40	250	80	4	RW4330	450	1
30	63	250	100	4	RW4403	450	1
100	63	250	100	4	RW4410	450	1
300	63	250	100	4	RW4430	450	1
30	80	250	125	4	RW4503	470	1
300	80	250	125	4	RW4530	470	1
500	80	250	125	4	RW4550	470	1
30	100	250	125	4	RW4603	470	1
100	100	250	125	4	RW4610	470	1
300	100	250	125	4	RW4630	470	1
30	125	250	125	4	RW4703	470	1
100	125	250	125	4	RW4710	470	1
300	125	250	125	4	RW4730	470	1
500	125	250	125	4	RW4750	470	1

Approved
as an export
version only!

RCCB – sensitive to alternating current Type AC

Selective switch-off
Export version – not approved in Germany

Function

Selective RCCB independent of the supply voltage for realising the protective measure "protection through automatic power supply cutoff", in compliance with the requirements of international construction regulations.

The selective RCCB requires a longer residual-current flow time for tripping than an undelayed RCCB.

This allows for selective switch-off with two switches connected in series in systems with sequenced distributions, i.e. with RCCBs connected in series (e.g.: 0.3 A S and 0.03 A) only that RCCB trips – in the event of fault – in whose immediate downstream system part the earth fault occurred.

Due to their long switch-off times and high rated residual currents, selective RCCBs only provide protection against fire and in case of indirect contact (fault protection).

Protection in case of direct touching (operator protection) is therefore not possible.

Characteristics

- 4-pole
 - Large range of products with
 - Rated currents from 16 A to 125 A
 - Rated residual currents 0.1 A to 0.5 A
 - Tripping independent of supply and auxiliary voltage
 - Sensitive to AC and pulsating DC residual currents (type A)
 - Sensitive to AC residual currents (type AC)
 - High short-circuit strength
 - Double-sided two-tier terminals for large conductor cross-section and busbar
 - Switch-position display
 - Viewing window for labels
 - Multi-functional switching knob with three functions:
 - **On** (top position)
 - **Off** (bottom position)
 - Display "**tripped**" (centre position)
- If the RCCB trips due to a fault, the switching knob stays in the centre position

Type of mounting

- Quick mounting on DIN rail in accordance with EN 50022 in any standard distribution
- Any mounting position

Areas of application

Main distributors in extended electricity supply systems with TN-S and TN-C-S systems, e.g. for

- Camping sites
- Marinas
- Allotment colonies
- Fairgrounds
- etc.

Here, selective RCCBs mostly protect the cables from the main distribution to the sub-distributions.

The use in TN-C networks and in systems in which electronic equipment might cause smooth DC residual currents or residual currents with frequencies of $\neq 50$ Hz is excluded.

Note

To ensure the selectivity of the RCCB, the rated residual current of this RCCB must be selected at least one level higher than that of the undelayed switch connected downstream.

Accessories

- RH11 auxiliary contact
- Label sheet
- Free pictoplan labelling software (see page 25)

Seite

Exclusive products for sector-specific uses – please note longer delivery times!

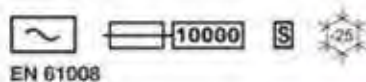

Rated resid. current $I_{\Delta n}$ mA	Rated current I_n A	Surge current strength > A	Max. back-up fuse A	Modules	Article no.	Weight g/each	Packing unit
--	-----------------------------	-------------------------------	------------------------	---------	-------------	------------------	-----------------



4-pole, selective switch off							
300	40	5,000	60	4	RW4330S	450	1
300	63	5,000	100	4	RW4430S	450	1
300	100	5,000	125	4	RW4630S	450	1
300	125	5,000	125	4	RW4730S	450	1

Residual current circuit breakers RP and RW product range

General explanations

General explanations regarding Residual Current Operated Protective Devices (RCDs)

Principle

A Residual Current operated protective Device – RCD for short – continuously calculates the sum of the instantaneous values of all currents that, via the active conductors, flow into an electrical system operated in an earthed AC network.

According to Kirchhoff's Current Law, this sum must always be zero. In the case of an insulation fault, the sum of these currents is not zero, because – depending on the fault impedance R_F and the ground loop resistance R_A – a residual current, also called differential current or fault current, does not flow back to the current source via the active conductors, but via the earth. If the effective value of the residual current exceeds the rated residual current $I_{\Delta n}$ of the RCD, the system is disconnected from the current source.

An auxiliary voltage source may be necessary to detect and assess the differential current, or it can be done independently of auxiliary voltage.

In Germany, the term "residual current" is used when designating RCDs that detect and assess the residual current independently of auxiliary voltage, whereas the term "differential current" refers to detection and assessment depending on auxiliary voltage.

Protection in case of indirect contact by automatically disconnecting the power supply according to VDE 0100 part 410 (fault protection)

If – in the case of an insulation fault – earthed, conductive system parts which are not part of the operating circuit (e.g. enclosures of equipment of protection class I) have a voltage higher than the maximum permissible touch voltage U_{Lzul} , the system to be protected must be disconnected from the power supply quickly. Earthing these parts with a sufficiently low earth resistance R_A allows for the touch voltage U_{Lzul} to cause a residual current to flow which activates an RCD and causes the system to be disconnected from the power supply immediately. To achieve this, the residual current must be higher than the rated residual current $I_{\Delta n}$ of the RCD.

The interrelationships are illustrated in Figure 1.

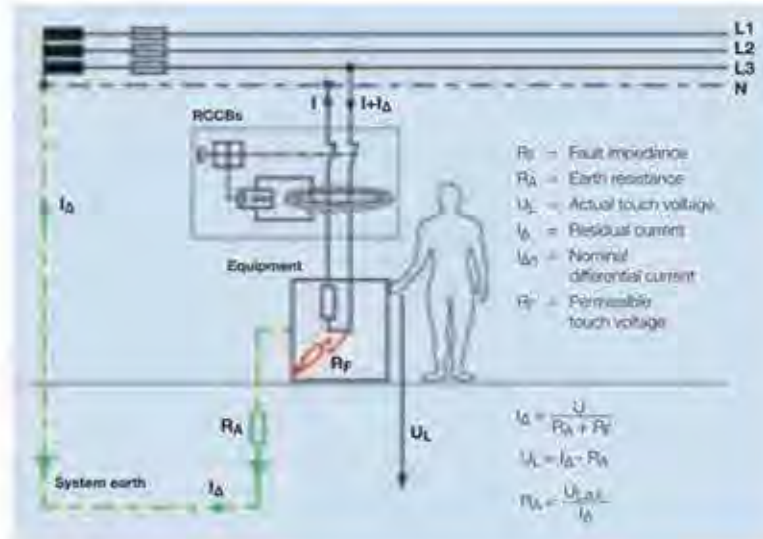

Figure 1

The maximum values for R_A for the maximum permissible touch voltages 25 V and 50 V can be found in the subsequent table. The resistance values for applications of up to 25 °C are reduced by a factor of 0,8, compared to the values for - 5 °C, because the response current I_{Δ} of the RCD at - 25 °C may exceed the rated residual current $I_{\Delta n}$ by 25%.

Rated fault current $I_{\Delta n}$ [A]	$I_{min.}$ U_{Lzul}	- 5 °C 25 V [Ω]	- 5 °C 50 V [Ω]	- 25 °C 25 V [Ω]	- 25 °C 50 V [Ω]
0.01		2500	5000	200	4000
0.03		830	1660	660	1330
0.10		250	500	200	400
0.30		83	166	60	130
0.50		50	100	40	80

Highest permissible earth resistance R_A depending on the rated residual current $I_{\Delta n}$ and the touch voltage U_{Lzul} at a minimum ambient temperature T_{min} of - 5 °C / - 25 °C. All earth resistances must have half the value for systems with selective RCD sequences!

Residual current circuit breakers RP and RW product range

Auslösecharakteristiken und Einsatzbereiche

Tripping behaviour of the RCDs at different time sequences of the differential current

Only in systems whose equipment exclusively consists of linear or approximately linear electrical components – i.e. the flow of current is proportional to the voltage – can it be assumed that, in case of fault, only pure AC residual currents with the frequency of the supply voltage flow to the ground. These are components with ohmic, inductive or capacitive behaviour.



Even for sinusoidal supply voltages, equipment consisting of non-linear passive or active components such as rectifier diodes or quick switches like thyristors or transistors can cause currents that contain strong harmonics and/or whose mean values are not zero for the duration of one supply-frequency period, i.e. that have a DC component.

The residual current can also have a frequency differing from the supply frequency or consist of several partial currents with frequencies differing from the supply frequency.

Therefore, RCDs with different technologies are also necessary to detect it.

The IEC 60755 technical report defines different types of RCDs as regards the time sequence of the residual currents which activate them.

This is illustrated in the following table.

RCD type	Sensitivity for differential/ fault currents	Symbol
AC	Pure AC residual currents with low harmonic component i.e. sinusoidal fault currents whose mean value is zero over a period of mains frequency	
A	Fault currents of type AC and pulsating DC residual currents, whose inst. value is approx. zero (< 6 mA) for the duration of at least a half period of the mains frequency.	
B	Fault currents of type A (i.e. also AC) as well as smooth DC residual currents and AC fault currents with frequencies up to 1000 Hz	

The table on the right-hand side (Figure 2) shows an arrangement of usual basic circuits of equipment with non-linear components (in short: electronic equipment, EE) and the time sequences of the resulting residual currents.

Just like the form of the current curve, the fundamental frequency of the residual current also has an influence on the response behaviour of the RCDs. Therefore, the response current and the response times are only within the range of the standardised values if the residual current frequency corresponds to the rated frequency of the RCDs.

For our standard devices, it is 50 Hz.

Area of application for AC und A-type RCDs

After the previous explanations, it can be seen that, in case of an earth fault, AC-type RCDs are only activated within the stipulated limits if an approximately sinusoidal residual current is flowing i.e. current whose time mean value is zero and that does not show any excessive distortions (harmonic component < 10%).

However, electronic components in similar circuits as illustrated in the table (Figure 3) on the next page are often used for modern equipment, e.g. to increase performance.

Thus, the time sequences of the possible residual currents are no longer sinusoidal, which means that, next to the supply frequency, there are also DC components and harmonics.

Even a slight DC component of the residual current makes AC-type RCDs more insensitive or completely inefficient as regards measuring the AC component. AC-type RCDs can thus only offer sufficient protection in systems whose equipment contains exclusively passive linear components and in which any later connection of non-permitted equipment – e.g. via plug connections – can be excluded.

Due to this restricted protection scope, AC-type RCDs are no longer allowed to be used in Germany and several other western European countries.

Instead, A-type RCDs are usually installed nowadays because they are also properly activated by pulsating DC residual currents. Their function is exclusively based on the principle of induction, as is the case with AC-type RCDs. Thus, they only react to residual currents that cause a sufficient change of the magnetic flow in the converter core. To achieve this, a residual current must pulsate in such a way that its instantaneous value is equal to or almost zero (≤ 6 mA) for at least half a supply-frequency period.

Therefore, A-type RCDs offer sufficient protection for electronic equipment with single-phase connection, except for EE with one-way rectifier and smoothing (Figure 3, circuit 2).

A-type RCDs do not react to residual currents with a high DC component or even smooth DC residual currents, as can be the case with EE with multi-phase connection (see circuits 3, 6 and 7 in Figure 3). Their intended function – reacting to A-type residual currents – even gets disturbed when there is smooth DC residual current at the same time.

Thus, according to EN 50178 / VDE 0160, EE than can create smooth DC residual currents must on no account be connected in system parts downstream of an A-type RCD.

If EE can cause residual currents with a high DC component (≥ 6 mA), i.e. protection by an A-type RCD is not guaranteed, the manufacturer of the equipment must point out this fact in the operating instructions.

Seite

Residual current circuit breakers RP and RW product range

Technical features and application notes

Area of application of B-type RCDs

If equipment according to the circuits 2, 3, 6 and 7 in Figure 3 (see previous page) can cause smooth DC residual current which is not detected by an A-type RCD, the manufacturer of the equipment must – under the terms of EN 50178 / VDE 0160 – point out that it is necessary to use a B-type RCD. This applies to almost all equipment of power electronics (EE) if it is operated in earthed networks without galvanic isolation in a three-phase manner, such as frequency converters, bigger UPS systems, welding inverters etc.

Such equipment usually delivers output voltage in the form of bipolar pulse-width modulated square-wave pulses with pulse frequencies in the range of 1 kHz up to several tens of kHz. For frequency converters, the resulting load current then has a sinusoidal shape – as a result of the inductance of the motors connected – with the desired adjusted motor frequency. Earth faults, however, normally display an ohmic resistance behaviour. That is why the output voltage of a frequency converter creates pulse-width modulated rectangular residual currents with the pulse frequency.

This means that for such applications, a RCD must also react to residual currents with the pulse frequency and their harmonics (3rd and 5th harmonic) to offer comprehensive protection. The response threshold must not exceed the maximum values permitted for a certain protection level (fault protection, fire protection or operator protection) for the whole frequency range.

Unfortunately, the current device standards do not pay the necessary attention to this point yet. The German VDE 0664-100 standard only offers details about the detection of residual current of up to 2 kHz and the international set of standard specifications IEC 60755 and the future IEC 62423 only require a residual current sensitivity of up to 1 kHz.

For these upper frequencies, residual-current response thresholds of up to approx. 20 or 10 times the rated residual current are still allowed.

However, for fire protection, for example, it would be necessary to have a response frequency range of up to at least 100 kHz with an upper response threshold of a maximum of 0.3 A.

Operational drainage currents with very different frequencies constantly flowing to the ground from equipment via suppressor capacitors, for example, are a serious problem that often makes the use of RCDs difficult. If they are high enough, they can undesirably activate a B-type RCD if it detects the residual current via a broad frequency range with high sensitivity. False tripping can often be avoided by selecting the RCDs with respect to their response-current frequency response and the rated residual current.

By choosing the equipment, it is, however, recommended to guarantee even while planning the system that the sum of the drainage currents does not exceed the lower response threshold of the RCDs and thus false tripping can be excluded.

For this purpose, we specify the frequency response of the response current for all device types in the catalogue texts of our various RCDs with tripping characteristic B.

Designs with increased surge current strength (KV type)

Pulse-shaped overvoltages caused by switching operations or thunderstorms can trigger discharge currents via the capacitance of the equipment to the ground or the interconnect capacitance resulting in undelayed RCDs being activated occasionally. Equipment with a high capacitance to the ground due to either the extensive dimensions of live parts or suppressor capacitors connected to the ground is critical in this regard.

Among the loads mentioned first are, for example, electrical panel heating and fluorescent lamps in big quantities (> 20 units per current path) with conventional ballasts.

The equipment mentioned second includes, amongst others, fluorescent lamps with electronic ballasts, X-ray equipment and computer systems. The use of our RCDs with increased surge current strength (for KV-type RCCBs) is recommended to guarantee reliable operation without false switch-off even in these especially critical cases.

These devices are largely resistant to surge residual currents because of a special design of the residual current detection and assessment unit.

Testing the surge current strength is normally carried out by means of the standardised lightning stroke current 8/20 according to IEC 60060-1.

There, the peak value of the highest current surge that can flow through the RCD transformer in both directions and via all current paths without causing tripping is used as a measurement.

The surge current strength of our standard RCCBs and RCBOs is > 200 A, while the designs with increased surge current strength with the KV-type addition have a surge current strength of more than 3 kA (> 5 kA upon request).

The other RCDs (CBRs and MRCDs) as well as the RCMs all have a surge current strength of up to > 3 kA. For all RCDs, the response time for normal sinusoidal residual currents is within the defined limits as demanded in IEC 60755 for undelayed devices or can be adjusted correspondingly for devices with selectable response times.

The following figure shows the switch-off times of an RCCB responding in an undelayed and in a delayed (selective) manner.

Residual current circuit breakers RP and RW product range

Technical features and application notes

Switch-off times

The figure "Switch-off times" on the [previous page](#) shows the switch-off times of our RCCBs and CBRs depending on a multiple of the rated residual current. From this, the switch-off times for circuit breakers of all rated residual currents can be determined for every desired residual current value.

Seite

Voltage dependence

A RCD independent of the mains voltage e.g. in the form of a conventional residual current circuit breaker (RCCB) takes the energy necessary for tripping only from the earth residual current. Even if the mains voltage drops or the neutral is disconnected, a RCCB is still functional. Even longer periods of overvoltage as a result of system disturbances have no impact on the tripping function of a residual current circuit breaker. Because of this high degree of operational reliability, a residual current circuit breaker is always to be preferred to a residual current operated protective device depending on the mains voltage.

In German systems that are not operated by personnel with technical expertise and not subject to regular maintenance carried out by experts, the basic protection measure "protection by automatic power-supply cut-off" in compliance with DIN/VDE 0100-410 must therefore only be realised with RCDs that are independent of auxiliary voltage. Our residual current circuit breakers meet the requirement of mains voltage independence.

Our DFS 4B RCCBs, sensitive to universal current, can also be considered independent of supply voltage in terms of the DIN EN 61008-1 VDE 0664-10 standard, because they react to A-type residual currents even in the case of loss of the supply voltage, i.e. if two phases and the neutral are interrupted. These devices only require a very little amount of auxiliary voltage, namely 30 V AC, for tripping with smooth DC residual currents and residual currents whose frequency differs from the supply frequency. This value is below the touch voltage of 50 V permitted in normal installations. Thus, the requirement of the VDE 0664-100 and even more that of the future international IEC 62423 standard is more than fulfilled.

Ambient temperature range

In almost all international standards, the normal ambient temperature range for RCDs is -5 °C to +35 °C with short-term temperatures of up to 40 °C for a maximum of 1h in 24h. Generally, our RCDs are upgraded for low temperatures of down to -25 °C. This quality is indicated by the  symbol on the nameplate of the devices.

If these RCDs are to work at temperatures below -5 °C, all international standards grant a tripping current which is 25 % higher. The earth resistance must thus be reduced to 80 % – compared to applications at temperatures down to -5 °C – to still achieve tripping at a touch voltage of $\leq 50 \text{ V} / \leq 25 \text{ V}$.

Short-circuit strength

RCDs must be protected against short circuits and, if it appears to be necessary, against overloading by means of suitable protection devices. The maximum prospective short-circuit current in connection with the maximum permissible back-up fuse (according to VDE 0636 utilisation category gL) is specified for our RCCBs in the data tables.

On the nameplate of the RCCB, the  symbol, for example, indicates that, in connection with a back-up fuse of 63 A, the circuit-breaker sustains a prospective short-circuit current of 10 kA. Our RCCBs for nominal currents of up to 63 A are sufficiently protected against short circuits by a back-up fuse of 63 A. In most cases, this guarantees a short-circuit current even through the service fuse (max. 63 A).

Please note that a short-circuit fuse does not automatically guarantee overload protection. Overload must be excluded by system planning taking simultaneity factors into account.

Installation notes

Mounting

Our RCDs can be used in any position. With the exception of B-type RCCBs, the infeed and load side are not defined either. 4-pole devices can also be used for 2 and 3-pole operation. Here, the voltage supply of the test equipment must be taken into account.

Mounting is carried out on DIN-rails according to DIN EN 50022. The IP 40 degree of protection that can be achieved with accurate terminal covers only guarantees touch protection and limited protection against solid foreign bodies. Without additional housing, the RCDs can thus only be used in dry and dust-free rooms.

We recommend additional housing of the IP 54 degree of protection for the use in rooms that are occasionally wet or in spots with increased dirt accumulation.

**RW product range
only approved as
an export version!**

Residual current circuit breakers RP and RW* product range

RP (sensitive to pulsating currents)/RW (sensitive to alternating currents),
Technical data

Technical data		Type A (sensitive to pulsating current) / Type AC (sensitive to alternating current)						
Tripping characteristic		16 A	25 A	40 A	63 A	80 A	100 A	125 A
Rated current I_n								
Rated residual current $I_{\Delta n}$	0,01 A	0,03 A / 0,1 A / 0,3 A / 0,5 A						
Surge current strength	0,5 μ s / 100 kHz / 200 A; ring-wave test							
Rated voltage U_n	230 V AC / 400 V AC							
Max. permissible operational voltage	$U_n + 10\%$							
Rated frequency	50 Hz							
Voltage operating area of the test equipment	2-pole: 100 V AC – 250 V AC / 4-pole: 185 V AC – 440 V AC							
Maximum switch-off times	$1 \times I_{\Delta n} : \leq 300 \text{ ms} / 5 \times I_{\Delta n} : \leq 40 \text{ ms}$							
Rated switching capacity I_m	500 A	500 A	500 A	800 A	800 A	1000 A	1250 A	
Rated fault switching capacity $I_{\Delta m}$	500 A	500 A	500 A	800 A	800 A	1000 A	1250 A	
Conditional rated short-circuit current I_{kC} 2-pole	10 kA							
Conditional rated fault short-circuit current $I_{\Delta C}$ 2-pole	10 kA							
Conditional rated short-circuit current I_{kC} 4-pole	10 kA							
Conditional rated fault short-circuit current $I_{\Delta C}$ 4-pole	10 kA							
Short-circuit back-up fuse	see table on page 97							
Power loss 2-pole 0,01 A (A, AC) / 0,03 A (AC)	1,5 W	3,5 W	8,0 W					
Power loss 2-pole 0,03 – 0,5 A	0,6 W	1,0 W	2,0 W	4,6 W	7,5 W	12 W	18 W	
Power loss 4-pole 0,03 – 0,5 A	0,7 W	1,5 W	4,0 W	8,5 W	14 W	22 W	30 W	
Operating position	Any							
Degree of protection	IP 40 (acc. to distr. board installation)							
Resistance to mechanical shocks	20 g / 20 ms duration							
Vibration resistance	> 5g ($f \leq 80 \text{ Hz}$, duration > 30 min)							
Ambient temperature range	-25° C to +40° C							
Resistance to climate	Acc. to DIN IEC 60688-2-30: Moist heat / cyclical (25 °C / 55 °C ; 93 % / 97 % rF)							
Cross sections of connection lines Circular conductor, solid	1 x 1,5 – 50 mm ² (1-conductor connection) / 2 x 1,5 – 16 mm ² (2-conductor connection)							
Multiple wire	1 x 1,5 – 50 mm ² (1-conductor connection) / 2 x 1,5 – 16 mm ² (2-conductor connection)							
Fine wire	1 x 1,5 – 35 mm ² (1-conductor connection) / 2 x 1,5 – 16 mm ² (2-conductor connection)							
Terminal screw torque	3 Nm							
Minimum conductor cross section	50 mm ²							
Mechanical service life	> 5.000 switching cycles							
Electrical service life	> 2.000 switching cycles							
Building regulations	Standards???							
	DIN VDE 0664 T 10, EN 61008-1, IEC 61008-1							

Seite

Technical data		Differences in technical data to the RP/RW table above						
Short-time delayed								
Surge current strength	3,000 A / lightning stroke current 8/20 μ s							
Selective								
Rated current I_n		40 A	63 A	80 A	100 A	125 A		
Rated residual current $I_{\Delta n}$		0,3 A						
Surge current strength	5,000 A / lightning stroke current 8/20 μ s							
Response delay	$1 \times I_{\Delta n} : 130 \text{ ms} < T \leq 500 \text{ ms} / 5 \times I_{\Delta n} : 50 \text{ ms} < T \leq 150 \text{ ms}$							

* The RW product range is an export version which is not approved in Germany.

RW product range
only approved as
an export version!

RCCBs

Product lines RP, RW* and RA

Short-circuit back-up fuses

Product range		Rated current I_n [A]	Rated residual current $I_{\Delta n}$ [A]	Short circuit back-up fuses SCPD [A]
2-pole	A	16	0.01	50
		25		
		40		
		16		
		25		
	AC	40	0.03 - 0.5	100
		63		
		16		
		25		
		40		
4-pole	A, B	16	0.01	50
		25		
		40		
		63		
		80		
	AC	100	0.03 - 0.5	125
		125		
		16		
		25		
		40		
AC	63	0.03 - 0.5	100	
	80			
	100			
	125			
	125			

Rated short-circuit current I_{nc} = for all RCCBs = 10 kA

* Product range RW is an export version which is not approved in Germany.

Rated voltage U_n	AC 230 V, suitable for networks up to 250 V
Rated residual current $I_{\Delta n}$ 10 mA	10 mA, 30 mA and 300 mA
Function limit for functions of the test equipment	AC 100 V
Short circuit withstand rating I_{cn} (according to DIN EN 61009)	6 kA and 10 kA
Energy limiting class	3
Frequencies	50 Hz to 60 Hz
Insulation coordination	Overvoltage category III, for degree of pollution according to DIN VDE 0110
EMC	According to DIN EN 61009 and DIN EN 61543
Installation devices	CB 1-pole+N(2 modules), CB-2-pole (3 modules)
Installation position	any
Degree of protection	IP 20 according to DIN 40 050
Connecting terminals	Both-sided multi-function terminal For simultaneous connection of conductors and pin rails
Terminal screws	+ and Pozidriv 2
Torque	2,5 to 3 Nm
Conductor cross sections	Single and multi-wire conductor: 0,75 to 35 mm ² Stranded wire with ferrule: 0,75 to 25 mm ²

Thermal trip and short circuit trip circuit breaker			
Characteristic		B	C
Test currents	Thermal not tripping I_1 (A) > 1 h	$1,13 \times I_n$	$1,13 \times I_n$
	Thermal tripping I_2 (A) < 1 h	$1,45 \times I_n$	$1,45 \times I_n$
	Electromagnetic not tripping I_4 (A) > 0,1 s	$3 \times I_n$	$5 \times I_n$
	Electromagnetic tripping I_5 (A) < 0,1 s	$5 \times I_n$	$10 \times I_n$

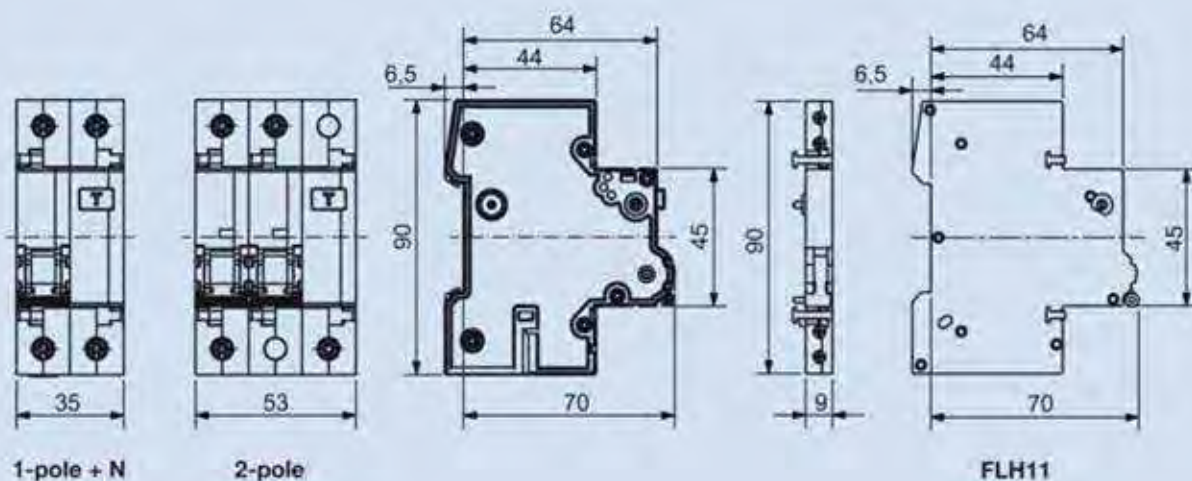

An extensive range of DIN-rail panel products

The desire for safety and convenience is making current installation in buildings ever more complex. Modern facilities management moves to the forefront.

Practical DIN-rail panel products offer many possibilities for meeting these demands.

Off switches and CO contacts, single or multiple pole, with or without light signal, buttons, SCHUKO sockets for DIN rails, installation/ storage/ control and time relays, remote switches, touch dimmers, network activators, installation contactors, staircase lighting timers, time switches and transformers – our pallet of DIN rail panel products is as varied as the requirements.





Button
16 A 250 V-

1 M

	Article no.	Weight g/each	Packing unit
1U	WT161	55	12

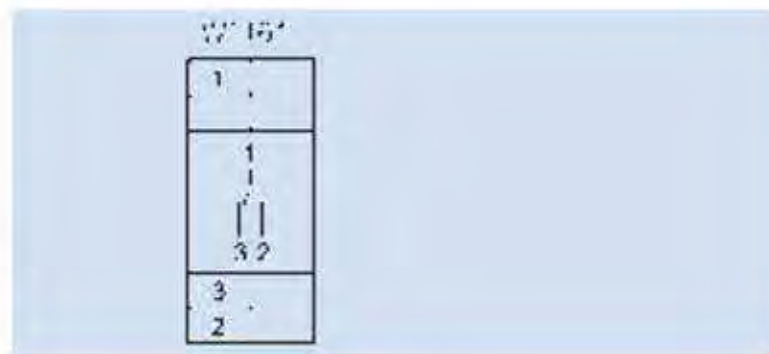

Button with light signal
16 A 250 V-

1 M

	Article no.	Weight g/each	Packing unit
1U	WTL161	55	12

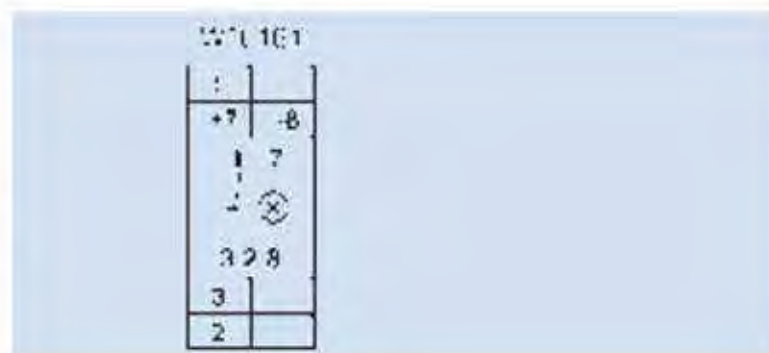

Light signal
110 - 230 V-

1 M

	Article no.	Weight g/each	Packing unit
Clear	LS230W	55	12
Red	LS230R	55	12
Green	LS230G	55	12

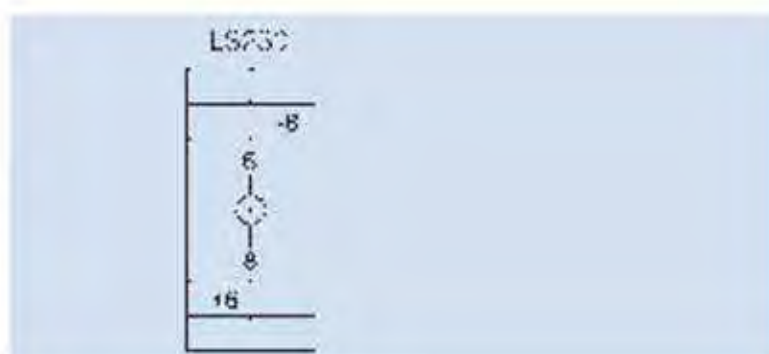

Off switch 3-pole
63 A 415 V-
Incoming circuit breaker for circuit distribution board, lockable in the "ON" or "OFF" position, maximum connection cross section 25 mm²

3 M

	Article no.	Weight g/each	Packing unit
3NO	AS63	200	4



SCHUKO socket outlet 
10/16 A 250 V-

2,5 M

	Article no.	Weight g/each	Packing unit
	SD230	110	4

Installation relay/Storage relay mechanical

Technical data / type	IR/ID	SP2301W
Contact material	AgSnO ₂	
Contact interval	3 mm / 2 mm	
Interval control connections / contact	> 6 mm	
Test voltage contact/contact	2000 V	
contact / magnet system	4000 V	
Nominal switching capacity AC 250 V, 400 V	16 A, 10 A / 10 A, 6 A	16 A / 250 V, 3,520 VA
Incandescent lamp load and halogen lamp load 230 V	10 A (2,300 W)	
Florescent lamp load in DUO switching	16 A (3,500 W) / 10 A (2,000 W)	
Florescent lamp load inductive or capacitive	10 A (1,300 W)	
Electronic ballasts	$I_{on} 140 A 10 ms / 70 A 10 ms$ ¹⁾	
Fluorescent lamp load compensated in parallel	4 A (500 W)	
Inductive load $\cos \varphi = 0.6 / 230 V AC$	10 A (1,300 W)	
High-pressure mercury lamp and metal halide lamp, uncompensated	500 W	
Contact load DC max.	100 W	
Mechanical service life, change of position 10 ³ / h	>10 ⁶	>10 x 10 ⁶
Service life with rated load, $\cos \varphi = 1$ und 10 ³ / h	>10 ⁷	
Service life with incandescent lights 1000 W and 10 ³ / h	>10 ⁵	
Service life with rated load, $\cos \varphi = 0.6$ und 10 ³ / h	>4 x 10 ⁴	
Switching frequency max.	10 ³ / h	10 ⁴ / h
Closing delay	10 - 20 ms	10 ms
Opening delay	5 - 15 ms	5 ms
Switch position display	per contact	Light emitting diode
Manual operation	yes	no
Switch-on duration	100% ²⁾	100%
Temperature at the installation location max. / min.	+50° / -5° C	+40° C
Control voltage range	0.9 to 1.1 x U _n	0.95 to 1.06 x U _n
Coil power loss AC + DC ± 20 %	1- and 2-pole 2 W	1.9 W
Total power loss when continually excited	1-pole 4 W	1.9 W
Rated voltage and rated contact load	2-pole 6 W	
Max. parallel capacitance (length) of the control line	0.06 µF (200 m)	
Max. induction voltage at the control inputs	0.2 x U _n	

1) For electronic ballasts, a switch-on current 40 times more powerful is to be expected.

2) Should several remote switches and installation relays be under continuous excitation, please make sure that there is sufficient ventilation in accordance with the power loss calculation and additionally that a ventilation interval of approx. 1/3 modules is observed.

Function description:

IR = Installation relay
 SP = Storage relay
 ID = Socket installation devices

Type key

e.g. installation relay
 article no. IR23011

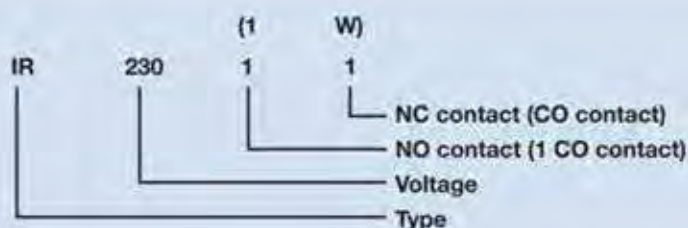

Electronic control relays	
Technical data / type	STU1W / STU2W / IDU10
Contacts	
Contact material / Contact interval	AgSnO ₂ / 0,5 mm
Interval control connections / contact	< 6mm, IDU10: 3 mm
Interval control connections C1-C2 / contact	
Test voltage contact / contact	1,000 V
Test voltage control connections / contact	4,000V, IDU10: 2,000 V
Nominal switching capacity AC	10A / 250V
Incandescent lamps and halogen lamp load 230 V for lamps with max. 200 W	1,000 W
Fluorescent lamp load in DUO switching	1,000 W
Fluorescent lamp load inductive or capacitive	1,000 W
Fluorescent lamp load compensated in parallel	4 A; 500 W
High-pressure mercury lamp and metal halide lamp, uncompensated	-
Electronic ballasts	(I_{on} max. 70A / 10ms ¹⁾)
Inductive load $\cos \varphi = 0.6$ / 230 V AC	5 A; 650 W
Max. switching current DC1: 12 V / 24 V DC	5 A
Service life with rated load, $\cos \varphi = 1$ or incandescent lamps 1,000 W at 100 / h	> 10 ⁵
Service life for rated load, $\cos \varphi = 0.6$ und 100 / h	> 4 x 10 ⁴
Switching frequency max.	10 ⁴ / h
Closing delay	5 - 10 ms
Opening delay	5 - 10 ms
Switch position display	Light emitting diode (not IDU10)
Box terminal cross section	12 mm ²
Maximum cross section of a conductor	6 mm ²
Screw heads slotted/cross slot	pozitriv
Touch protection (device side)	DIN EN 50274, VDE 0660-514 BGV A3
Electronics	
Switch-on duration	100 %
Temperature at the installation location max. / min.	+50°C / -20°C
Minimum command duration / control voltage area	50 ms / 0.9 to 1.1 x U _n
Coil power loss AC+DC ± 20%	1U 0.5 W; 2U 0.8 W
Control current	12 V UC: 90 mA ²⁾
	230 V UC: 20 mA ²⁾
Max. parallel capacity (length) of the control line	0.06 µF (approx. 200 m)

Fulfilled EN 61000-6-3, EN 61000-6-1 and EN 60669 standards

¹⁾ For electronic ballasts, a switch-on current 40 times more powerful is to be expected.

²⁾ Control relays STU1W and STU2W are clocked. From this, currents of up to 1 A result in the µs range.

Remote mechanical switches
Technical data / type
FS/FD

Contact material	Ag Sn O ₂
Contact interval	3 mm / 2 mm
Interval control connections / contact	> 6 mm
Test voltage contact / contact	2,000 V
contact / magnet system	4,000 V
Nominal switching capacity AC 250 V, 400 V	16 A, 10 A / 10 A, 6 A
Incandescent lamp load and halogen lamp load 230 V	10 A (2,300 W)
Fluorescent lamp load in DUD switching	16 A (3,500 W) / 10 A (2,000 W)
Fluorescent lamp load inductive or capacitive	10 A (1,300 W)
Electronic ballasts	I _{on} 140 A 10 ms / 70 A 10 ms ¹⁾
Fluorescent lamp load compensated in parallel	4 A (500 W)
Inductive load cos φ = 0.6/230 V AC	10 A (1,300 W)
High-pressure mercury lamp and metal halide lamp, uncompensated	500 W
Contact load DC max.	100 W
Service life with rated load, cos φ = 1 and 10 ³ / h	>10 ⁶
Service life with incandescent lamps 1,000 W and 10 ³ / h	>10 ⁵
Lebensdauer bei Glühlampen 1,000 W und 10 ³ / h	>10 ⁵
Service life with rated load, cos φ = 0.6 and 10 ³ / h	>4 × 10 ⁴
Switching frequency max.	10 ³ / h
Switch position display	per contact
Manual operation	yes
Switch-on duration	100% ²⁾
Temperature at the installation location max. / min.	+50° / -5° C
Control voltage area	0.9 bis 1.1 × U _n
Coil power loss AC + DC ± 20%	1- and 2-pole 5 - 6 W
Total power loss when continually excited	1-pole 7 - 8 W
Rated voltage and rated contact load	2-pole 9 - 10 W
Max. parallel capacity (length) of the control line	0.06 μF (200 m)
Max. induction voltage at the control inputs	0.2 × U _n
Glow lamps parallel to the 230 V control buttons	5 mA
With capacitor 1 μF/250 V AC parallel to the coil	10 mA
With capacitor 2.2 μF/250 V AC parallel to the coil	15 mA

1) For electronic ballasts, a switch-on current 40 times more powerful is to be expected.

2) If several remote switches and installation relays are under continuous excitation, please make sure that there is sufficient ventilation in accordance with the power loss calculation and additionally that a ventilation interval of approx. 1/2 module is observed.

Funktionsbeschreibung:

FS = Remote switch
 FD = Socket installation devices
 SS = Remote series switch

Type key

e.g. remote switch
 article no. FS23011



Electronic remote switch		
Technical data / type	FSSTU2M ^{a)}	FDU10 ^{a)}
Contacts		
Contact material / Contact interval	AgSnO ₂ / 0,5 mm	AgSnO ₂ / 0,5 mm
Interval control connections / contact kontakt interval A-A2 / contact	6 mm -	3 mm 8 mm
Test voltage contact / contact	4,000 V	-
Test voltage control connections / contact	4,000 V	2,000 V
Test voltage A1-A2 / contact	-	4,000 V
Nominal switching capacity AC	16 A / 250 V	16 A / 250 V
Incandescent lamps and halogen lamp load 230 V ¹⁾	2,000 W	2,000 W
Fluorescent lamp load in (conventional ballast) DUO switching	1,000 VA	1,000 VA
Fluorescent lamp load in (conventional ballast) uncompensated or serially compensated	1,000 VA	1,000 VA
Fluorescent lamp load (conventional ballast) compensated in parallel	500 VA	500 VA
Fluorescent lamps (electronic ballast)	500 VA	500 VA
Electronic ballasts	$I_{on} \max. 70 \text{ A} / 10 \text{ m s}^{-2}$	
Max. switching current DC1: 12 V / 24 V DC	8 A	8 A
Service life with rated load, $\cos \varphi = 1$ or incandescent lamps 1,000 W for 100 / h	$>10^5$	$>10^5$
Service life with rated load, $\cos \varphi = 0,6$ and 100 / h	$>4 \times 10^4$	$>4 \times 10^4$
Switching frequency max.	$10^3 / \text{h}$	$10^3 / \text{h}$
Box terminal cross section	12 mm ² ³⁾	M3
Maximum cross section of a conductor	6 mm ² ³⁾	2,5 mm ²
Screw head	Slotted/cross slot pozidriv	Slotted
Touch protection (device side)	DIN EN 50274, VDE 0660-514 BGV A3	
Electronics		
Switch-on duration (also centrally on/off)	100%	
Temperature at the installation location max. / min.	+50 °C / -20 °C	+50 °C / -20 °C
Minimum command duration / control voltage area	50 ms	50 ms
Control current during local control $\pm 20\%$	12 V 24 V 230 V	0,1 mA 0,2 mA 1,0 mA
Glow lamp current at the control input $\pm 20\%$	2 mA / 100 mA (5 mA)	5 mA
Control current A1-A2 8 V / 230 V		2/2 mA
Max. parallel capacitance (length) of the individual control line for 230V AC	0,2 μF (approx. 600 m)	0,2 μF (approx. 600 m)

Fulfilled EN 50081-1, EN 50082-2 and EN 60669 standards

a) Bistable relays as NOC. After installing the automatic synchronisation, wait about 2 seconds before putting the switched load on the mains

1) For lamps with max. 200 W

2) For electronic ballasts, a switch-on current 40 times more powerful is to be expected

3) Partially with 3 terminals: terminal 7mm², max. conductor 4 mm

Remote switch - Central control



**Remote switch - Central control
4 remote switches**

16 A / 250 V, each 1 NO floating
Incandescent lamp load 2,000 W
Stand-by loss 0.1 W

2 M

	Article no.	Weight g/each	Packing unit
8 to 230 V UC	FZU40	147	6

**Wiring diagram:
Remote switch central control**

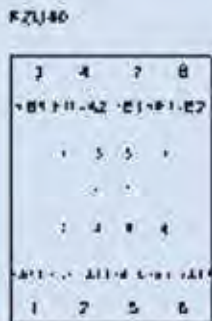

**FZU40 remote switch for central control with 4 independent remote switching functions
Local universal control voltage 8..230 V UC.**

With additional control inputs central on and central off for 8..230V UC, galvanically separated from the local control input.

With additional group control inputs on and off for 8..230 V UC. Same potential as the local control inputs.

Using the group control inputs, groups of these impulse switches can be activated separately in a central control facility e.g. for emergency lighting.

Central commands always have priority, local control inputs are blocked for the duration of the central command.

Incandescent lamp current from 110 V, control voltage up to 30 mA. With acknowledgement output ER (= +B1) for the control of a relay up to 2 Watts.

Control output requirements with supply voltage.

Internally-clocked universal voltage relays are not suitable in this case.

Circuit example for a central control "Central ON + OFF" with remote switches FZU40

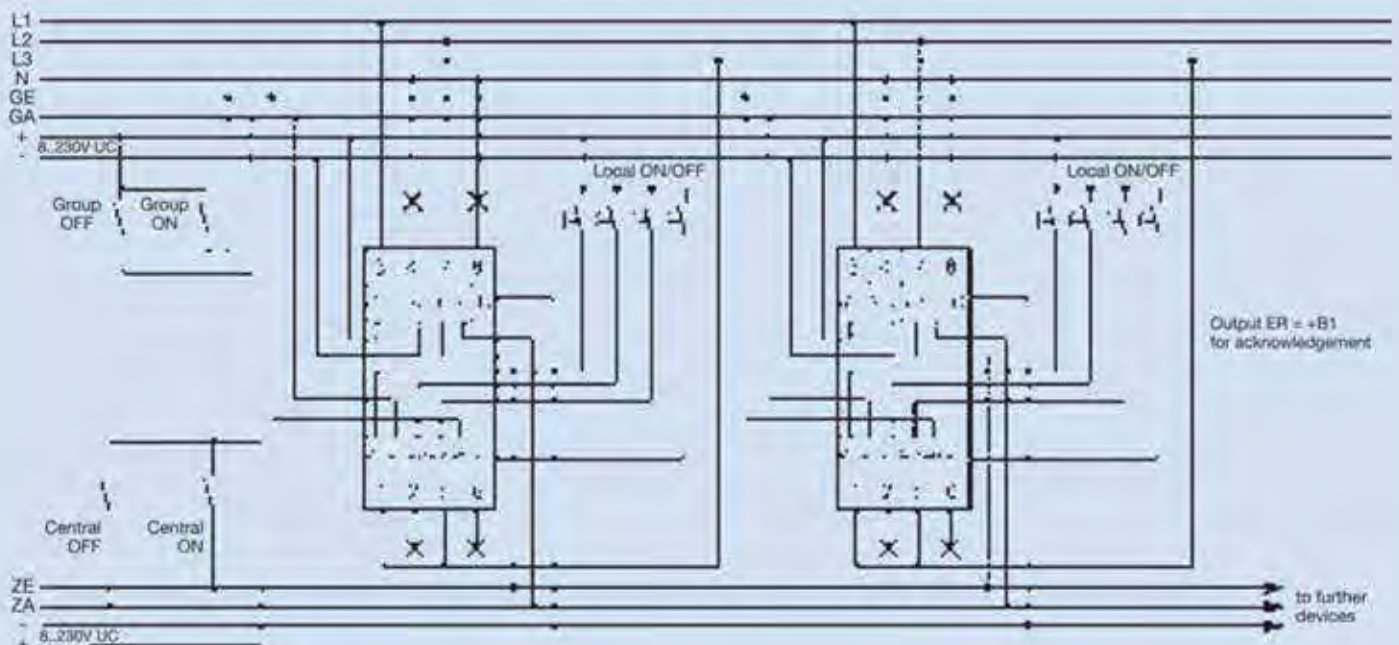

Touch dimmer



Touch dimmer

Universal control voltage
8 to 230 V UC, 500 W
for incandescent lamps, halogen
lamps and low-voltage halogen
lamps

1 M

Article no.	Weight g/each	Packing unit
TDU500	96	1

**Electronic universal touch dimmer for R, L and C loads
Universal control voltage 8..230 V UC, galvanically separated
from supply and switching voltage 230 V.**

Short control commands switch on/off, permanent activation adjusts brightness up to the maximum value.
A brief interruption of the activation alters the dimming direction.
The set level of brightness remains saved when switched off.

With switches for children's rooms:

When switching on and pressing the button for at least 1 second, the light will switch on at the lowest brightness level and slowly increase brightness, without altering the last brightness level saved.

With sleep function:

The lighting is dimmed from its current brightness and switches off when it receives a double impulse. The maximum dimming time of 60 minutes is dependent on the current brightness and can be shortened accordingly. The dimming procedure can be paused at any time with renewed pressing of the button.

Defined switch-off during electricity failure.

From 110 V control voltage, incandescent lamp current 30 mA

With the % \odot -rotary switch the minimum brightness can be set (completely dimmed) e.g. for dimmable energy-saving lamps.

The **dim speed rotary switch** can be used to set the dimming speed.

At the same time the duration of the soft ON and soft OFF is altered.

The **ESL** settings take into consideration the special conditions for dimmable energy-saving lamps: The switching-on procedure is optimised and the dimming rate is altered logarithmically. The children's room switch is not possible in these settings and wound (inductive) transformers are not allowed to be dimmed.

Memory is switched off in the ESL setting. This can be advantageous with ESL, since cold ESL require a higher minimum brightness than might be stored in the memory with warm ESL.

Automatic electronic overload protection and thermal overload switch-off.

L loads (inductive loads, e.g. wound transformers) and C loads (capacitor loads, e.g. electronic transformers) must not be mixed. L and C loads can be mixed as desired with R loads (ohmic loads, e.g. 230 V incandescent and halogen lamps).



Technical data for dimmer TDU500 ¹⁾

Incandescent lamps 230 V (R)	500 W
Halogen lamps 230 V (R)	500 W
Inductive transformers (L)	500 W ^{2) 3)}
Electronic transformers (C)	500 W ^{2) 3)}
Dimmable energy-saving lamps ESL	100 W ⁴⁾
Temperature at the installation location max. / min.	+50 °C / -20 °C ⁵⁾
Control voltage area	0,9 bis 1,1 x U _n
Constant current supply	12 mA

The parallel operation of inductive (wound) and capacitive (electronic) transformers is not allowed!

- 1) For loads greater than 300 W, a ventilation interval of 1/2 module is to be maintained to devices mounted next to each other.
- 2) A maximum of two inductive (wound) transformers are allowed per universal dimmer switch and only the same types may be used; in addition, secondary-side idling is not allowed. Otherwise the universal dimmer switch may be destroyed! Therefore no secondary-side load switch-off allowed.
- 3) When calculating loads, 20% loss for inductive (wound) transformers and 5% loss for capacitive (electronic) transformers must be taken into account in addition to the lamp load.
- 4) In the ESL settings, no inductive (wound) transformers may be dimmed.
- 5) Influences the maximum switching capacity.

Connection example

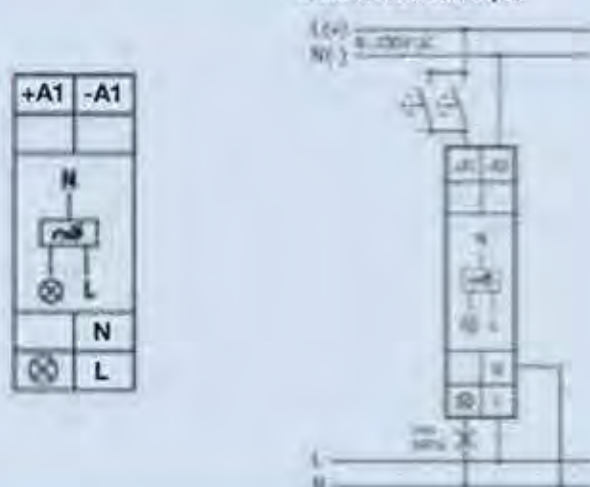

Twilight switch

**Twilight switch
with separate light collector**

 230 V~, 50 ... 60 Hz
 16 A, 1 co contact

2 M

	Article no.	Weight g/each	Packing unit
	DS2301W	230	1

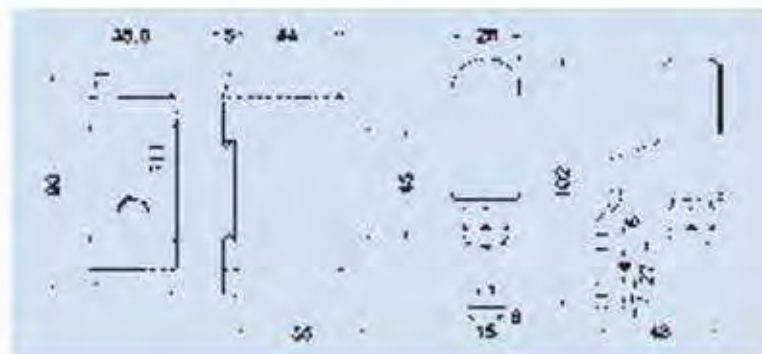
Twilight switch DS2301W
Technical data

Light intensity Area 1 Area 2 Area 3	2 - 100 Lux 2 - 1,000 Lux 2 - 10,000 Lux
Delay when switching on	8 sec.
Delay when switching off	38 sec.
Contact material	AgCdO
Contact interval	< 3 mm
Interval control connections / contact	5 mm
Rated insulation voltage contact / contact contact / magnet system	1 kV 4 kV
Switching capacity AC	16 A / 250 V cos φ = 1
Switching capacity	2,300 W
Inductive load cos φ = 0.8	3 A / 250 V
Mechanical service life, change of position	5 x 10 ⁷
Service life with rated load, cos φ = 1 and 10 ³ / h	10 ⁶
Service life with incandescent lamps 1,000 W and 10 ³ / h	25 x 10 ³
Service life with rated load, cos φ = 0.6 und 10 ³ / h	75 x 10 ³
Switch position display relay	LED red
Switch position display switch point	LED green
Switch-on duration	100%
Temperature at the installation location min. / max.	0 °C to 55 °C
Total power loss during continuous excitation	2.2 W
Degree of protection	IP 20
Protection type light collector	IP 65
Max. cable length to light collector	100 m

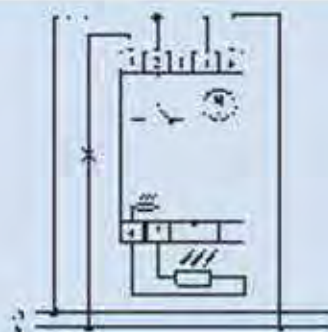
**Wiring diagram:
Twilight switch
with separate light collector**

Connection example for network activator FR23010 with standard connection and base load element GLE1230

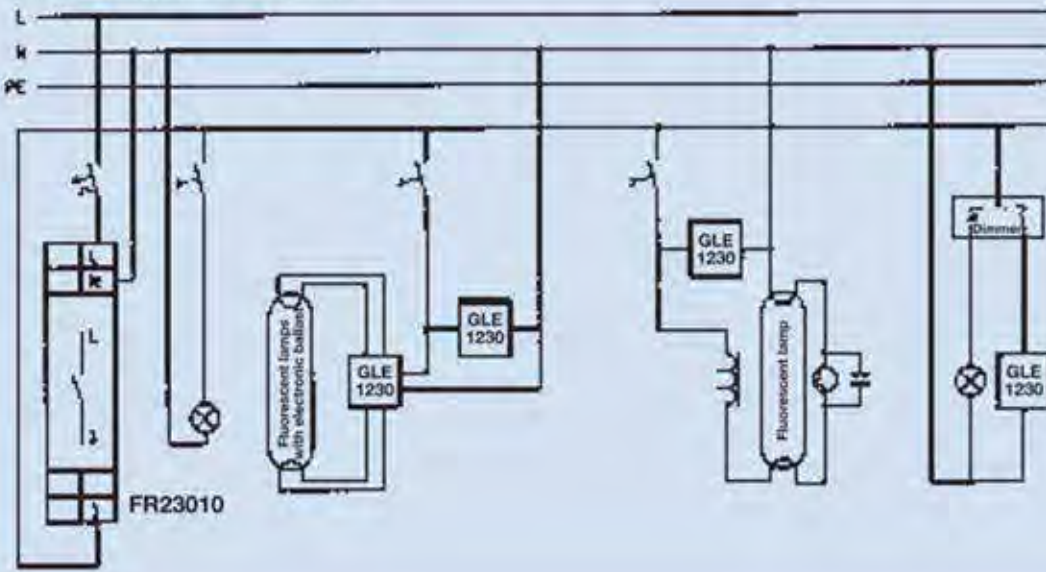

Anschluss des Netzfreischaltrelais

Klemme L = Phase

Klemme N = Nulleiter

Klemme 3 = Überwachter Leiter

Connection example Rotary dimmer with generalised phase control for ohmic and inductive loads

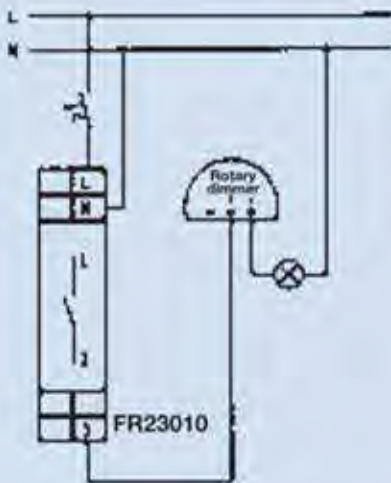

Connection example Rotary dimmer with generalised phase control for electronic transformers

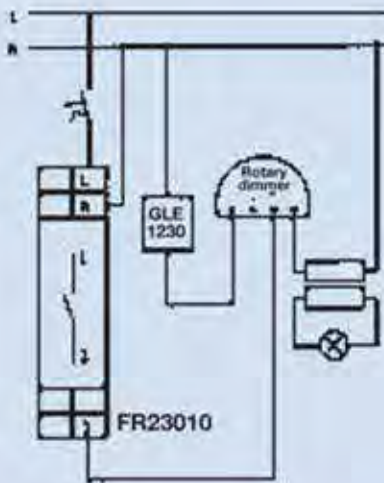

Function descriptions

RV = Release delay

(Delay in switching off)



When applying control voltage, the NOC changes to 15 -18. With the interruption of the control voltage, the time period begins and at its end the NOC returns to its rest position. Can be reset during the time period.

AV = Response delay

(Delay when switching on)

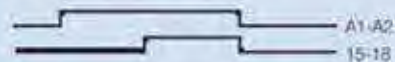

With the application of the control voltage, the time period begins and at its end the NOC changes to 15-18. After an interruption, the time period starts again.

TI = Clock generator starting with impulse

(Flashing relay)

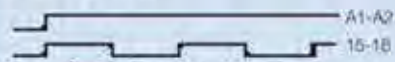

As long as the control voltage is applied, the NOC closes and opens. For MRU1W the switching time in both directions is identical and corresponds to the time set. For TIUMW both times can be set separately. When the control voltage is applied, the NOC immediately changes to 15 -18.

TP = Clock generator starting with pause

(Flashing relay)

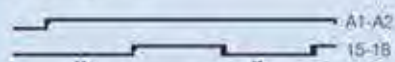

Function descriptions same as TI, except that when the control voltage is applied, the contact does not change to 15-18 but rather first remains at 15-16 or open.

IA = Impulse-controlled response delay

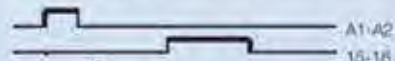

With the start of a control pulse from 20 ms, the timing period t1 starts; at its end, the NOC changes to 15-18 for the time t2 (= 1 second) (e.g. for automatic door openers). If t1 is set to the shortest time of 0.1 seconds, IA operates as an impulse former, for which t2 elapses, independent of the control signal's duration (min. 150ms).

EW = Einschaltwischrelais

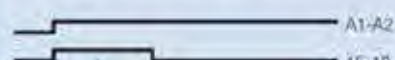

Mit dem Anlegen der Steuerspannung wechselt der Arbeitskontakt nach 15-18 und kehrt nach Ablauf der Wischzeit zurück. Bei Wegnahme der Steuerspannung während der Wischzeit kehrt der Arbeitskontakt sofort in die Ruhelage zurück und die Restzeit wird gelöscht.

AW = Passing break contact relay

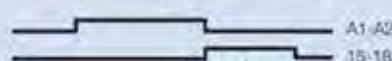

When the control voltage is interrupted, the NOC changes to 15-18 and returns after the impulse time has elapsed. If the control voltage is applied during the impulse time, the NOC immediately reverts to its rest position and the residual time is deleted.

ARV = Response and release delay

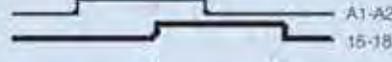

When the control voltage is applied, the timing period is started; at its end the NOC changes to 15-18. If the control voltage is interrupted after this, another timing period is started; at its end the NOC returns to the rest position. This release delay is identical to the response delay. After an interruption of the response delay, the time period begins again.

EAW = Passing make contact relay and passing break contact relay

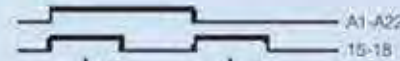

When the control voltage is applied and interrupted, the NOC changes to 15-18 and returns after the set impulse time has elapsed.

IF = Impulse former

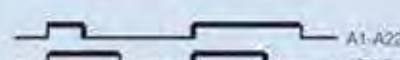

When the control voltage is applied, the NOC changes to 15-18 for the time set. Further activations are only evaluated after the set time has elapsed.

ARV+ = Additive response and release delay

Same function as the ARV, but after an interruption of the response delay, the elapsed time remains stored.

ESV = Impulse switch with release delay and pre-warning of switch-off

Function as SRV. Also with pre-warning of switch-off; approx. 30 seconds before time elapses, the light flickers 3 times in shorter and shorter periods.

AV+ = Additive response delay

Same function as the AV, but after an interruption, the time already elapsed remains stored.

SRV = Impulse switch with release delay

The NOC switches back and forth with control impulses from 50ms. In contact position 15-18, the device automatically switches to the rest position after the delay time has elapsed.

Mains monitoring

Mains monitoring

NW1
NWA1 asymmetrical monitoring
UAB 154 V, UAN 198 V

2 M

	Article no.	Weight g/each	Packing unit
1NO + 1NC	NW1	98	1
	NWA1	98	1

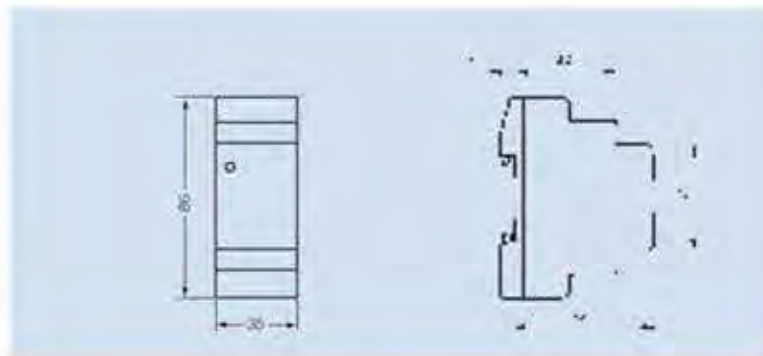
Mains monitoring

NW2
NWA2 asymmetrical monitoring
UAB 187 V, UAN 210 V
acc. to VDE 0108
(safety lighting)

2 M

	Article no.	Weight g/each	Packing unit
1NO + 1NC	NW2	98	1
	NWA2	98	1

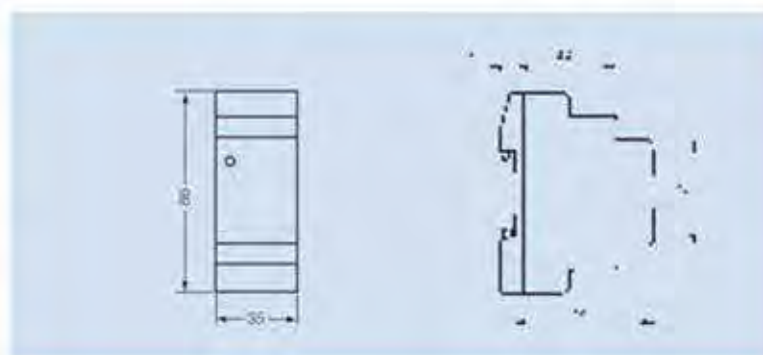

Mains monitoring	NW1* / NW2*		NWA1* / NWA2*	
	Technical data / type	1 - 3-phase 230 / 400 V		3-phase 230 / 400 V
Mains connection	via L1-N 230 V AC			
Operational voltage	45...65 Hz			
Frequency	5.5 VA			
Power consumption	0.15...0.5 Sek.			
Response / drop delay	2.5 KV			
Input pulse amplitude max. 6 ms	1.0 KV			
20 ms	none		10%	
Asymmetrical monitoring				
Relays				
Contact material	Ag-Ni 0.15 + HV			
Contact interval	> 0.35			
Interval control connections / contact	15 mm			
Rated insulation voltage contact / contact	1,000 V _{eff}			
contact / magnet system	4,000 V _{eff}			
Rated switching capacity	2,000 VA			
Contact load DC max. (A) 24 V	8 A			
60 V	1.8 A			
110 V	0.4 A			
220 V	0.3 A			
Minimum contact load	10 mA / 12 V			
Mechanical service life	3 x 10 ⁷			
Service life with rated load, cos φ = 1	100,000			
Service life with rated load cos φ = 0.4	80,000			
Switching frequency max.	3,000/h			
Switch position display	LED			
Switch-on duration / switching safety	100% ED			
Temperature at the installation location max. / min.	-40 °C / + 70 °C			
Total power loss during constant excitation	0.55 VA			

* No back-up fuse necessary since device is inherently stable

Technical data acc. to IEC 947-3, IEC 947-5-1, VDE 0660, EN 60947-3, EN 60947-5-1

Main contact element types		IS20..	IS25..	IS40..	IS63..
Rated insulation voltage U_i	V AC	440	440	440	440
Rated operational voltage U_e	V AC	250	440	440	440
Allowed switching frequency z	AC1, AC3.1 / h	300	300	600	600
Mechanical service life	$S \times 10^6$	1	1	1	1
Usage category AC1					
Rated operational current $I_o (=I_{th})$ open	at 60 °C A	20	25	40	63
Switching element service life	$S \times 10^6$	0.1	0.1	0.1	0.1
Power loss per pole for I_o /AC1	W	2	2	3	7
Usage category AC3 – Switching of three-phase motors					
Rated operating current I_o	A	-	9	27	30
Rated power for 220 V	kW	-	2.2	7.5	8
Three-phase motors 230 - 240 V, 50 - 60Hz	380 - 415 V	1.1	2.5	8	8.5
		-	4	12.5	15
Switching element service life	$S \times 10^6$	-	0.15	0.15	0.15
Magnetic coil output	Switching VA	7 - 9	14 - 18	33 - 45	33 - 45
	Stop VA	2.2 - 4.2	4.4 - 8.4	7	7
Alternating current activation		0.8 - 1.6	1.6 - 3.2	2.6	2.6
	W				
Magnetic coil operating areas					
Control voltage dependency U_s		0.85 - 1.1	0.85 - 1.1	0.85 - 1.1	0.85 - 1.1
Short circuit protection					
Max. back-up fuse main circuits	gL (gG) / A	35	35	63	80
Switching times for control voltage $U_s \pm 10\%$	Closing delay ms	7 - 16	9 - 15	11 - 15	11 - 15
	Opening delay ms	6 - 12	4 - 8	6 - 13	6 - 13
	Arc duration ms	10 - 15	10 - 15	10 - 15	10 - 15
Connection cross sections					
Single or multiple wire main conductor	mm ²	1.5 - 10	1.5 - 10	2.5 - 25	2.5 - 25
Stranded wire	mm ²	1.5 - 6	1.5 - 6	2.5 - 16	2.5 - 16
Stranded wire with ferrule	mm ²	1.5 - 6	1.5 - 6	2.5 - 16	2.5 - 16
Number of clampable conductors per terminal		1	1	1	1
Coil single wire or multiple wire	mm ²	0.75 - 2.5	0.75 - 2.5	0.75 - 2.5	0.75 - 2.5
Stranded wire	mm ²	0.5 - 2.5	0.5 - 2.5	0.5 - 2.5	0.5 - 2.5
Stranded wire with ferrule	mm ²	0.5 - 1.5	0.5 - 1.5	0.5 - 1.5	0.5 - 1.5
Number of clampable conductors per terminal		1	1	1	1
Auxiliary contact ISH11					
Rated insulation voltage U_i	V AC	440			
Thermal rated current = I_{th}	40 °C	10			
	60 °C	6			
Usage category AC15					
Rated operational current I_o	220 - 240 V	A	3		
	380 - 415 V	A	2		
	440 V	A	1.6		
Usage category DC13					
Rated operational current I_o each pole	24 - 60 V	A	2		
	110 V	A	0.4		
	220 V	A	0.1		
Short-circuit protection					
Largest rated current of the fuses short-circuit current 1kA, without welding the contacts	gL (gG) / A	10			

Lampenart	Output Watt	Current I _n / A	Capacitor µF	Max. number of lamps per conducting path for 230 V 50 Hz and max. 60 °C			
				IS20..	IS25..	IS40..	IS63..
Metal halogen lamps uncompensated e.g. high-pressure mercury lamp and metal halide lamp, CDM	35	0.53	-	22	24	57	65
	70	1	-	12	14	30	35
	150	1.8	-	6	8	17	18
	250	3	-	4	5	10	12
	400	3.5	-	3	4	8	10
	1,000	9.5	-	1	1	3	4
	2,000	16.5	-	-	-	2	2
	2,000 / 400 V	10.5	-	-	-	2	1
	3,500 / 400 V	18	-	-	-	1	1
Metal halogen lamps compensated e.g. high-pressure mercury lamp and metal halide lamp, CDM	35	0.25	6	8	6	42	56
	70	0.45	12	4	4	21	29
	150	0.75	20	2	2	13	18
	250	1.5	33	1	1	9	11
	400	2.1	35	1	1	9	10
	1,000	5.8	95	-	-	3	4
	2,000	11.5	148	-	-	2	2
	2,000 / 400 V	6.6	58	-	-	3	4
	3,500 / 400 V	11.5	100	-	-	2	3
Metal halogen lamps with electronic ballast (e.g. PCI) 50 - 125 x I _n lamps for 0.6 ms	20	0.1	Integrated	9	9	18	20
	35	0.2	Integrated	6	6	11	13
	70	0.36	Integrated	5	5	10	12
	150	0.7	Integrated	4	4	8	10
Low pressure sodium vapour lamps uncompensated	35	1.5	-	7	9	22	30
	55	1.5	-	7	9	22	30
	90	2.4	-	4	6	13	19
	135	3.5	-	3	4	10	14
	150	3.3	-	3	4	10	14
	180	3.3	-	3	4	10	14
	200	3.3	-	3	4	10	14
Low pressure sodium vapour lamps compensated	35	0.31	20	3	3	15	18
	55	0.42	20	2	2	15	18
	90	0.63	30	1	1	10	12
	135	0.94	45	1	1	7	8
	150	1	40	1	1	8	9
	180	1.16	40	1	1	8	9
	200	1.32	25	-	-	10	12
High pressure sodium vapour lamps uncompensated	150	1.8	-	5	6	15	22
	250	3	-	4	5	10	13
	330	3.7	-	3	4	8	10
	400	4.7	-	2	2	6	8
	1,000	10.3	-	1	1	3	4
High pressure sodium vapour lamps compensated	150	0.83	20	2	2	20	25
	250	1.5	33	1	1	12	15
	330	2	40	1	1	10	13
	400	2.4	48	1	1	8	12
	1,000	6.3	105	-	-	4	6
High pressure sodium vapour lamps Sodium vapour lamps with electronic ballast (e.g. PCI) 50 - 125 x I _n lamp for 0.6 ms	20	0.1	Integrated	9	9	18	20
	35	0.2	Integrated	6	6	11	13
	70	0.36	Integrated	5	5	10	12
	150	0.7	Integrated	4	4	8	10

Technical data stair light timing switch	TZA2301 *
Contacts	
Contact material / contact interval	AgSnO ₂ / 0.5mm
Interval control connections / contact	3 mm
Interval A1-A2 / contact	6 mm
Test voltage control connections / contact	2,000 V
Test voltage A1-A2 / contact	4,000 V
Nominal switching capacity AC	16 A / 250 V
Incandescent lamps and halogen lamp load 230 V ¹⁾	2,300 W
Fluorescent lamp load (conventional ballast) in DUO switching or uncompensated	1,000 VA
Fluorescent lamp load (conventional ballast) with parallel compensation or with electronic ballast	500 VA
Compact fluorescent lamps with electronic ballast And energy-saving lamps ESL	15 x 7 W 10 x 20 W
Service life with rated load, cos φ = 1 or for incandescent lamps 1,000 W for 100 / h	>10 ⁵
Service life with rated load, cos φ = 0,6 to 100 / h	>4x10 ⁴
Switching frequency max.	10 ³ / h
Box terminal cross sections	12 mm ²
Maximum cross section of a conductor	6 mm ²
Screw head	Slotted / cross slot, pozidriv slot
Touch protection (device side)	VDE 0106 part 100
Electronics	
Switch-on duration	100%
Temperature at the installation location max. / min.	+50 °C / -20 °C
Stand-by loss (active power)	0.5 W
Control current locally at 230 V (<10 s) \pm 20%	15 mA
Max. parallel capacity (approx. length) of the individual control lines for 230 V AC	0.06 μ F (approx. 200 m)

**Fulfilled EN 61000-6-3, EN 61000-6-1 and EN 60 669 standards
With pre-warning of switch-off acc. to DIN 18015-2**

* Bistable relay as NOC. Wait for automatic synchronisation after installation before applying the switched load to the mains.

1) For lamps with max. 150 W.

Digital timer

Digital timer

230 V~, 50/60 Hz, 16 A
 1 channel, 50 storage places
 2 channels, 50 storage places
 Program 24 h, 7 days

2 M

	Article no.	Weight g/each	Packing unit
1 channel	DZ201	170	1
2 channels	DZ302	170	1

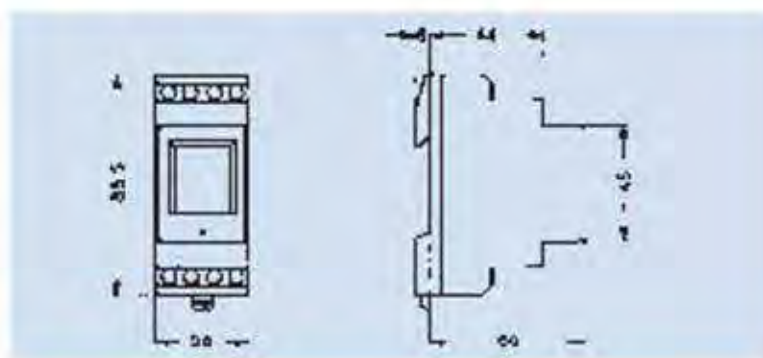

Technical data / Typ	DZ201	DZ302
Operational voltage	220-240 V / 50-60 Hz	
Power input up to 230 V~ (AC)	5 VA	
Switching capacity AC Ohmic load (VDE, IEC) Inductive load cos. φ 0,6 Incandescent lamp load	16 A / 250 V AC 8 A / 250 V AC 1.000 W	
Switching capacity DC 24 V~ 50 V~ 220 V~	800 mA 300 mA 150 mA	
Switching output	Floating	
Switching contacts	1 CO contact	2 CO contact
Ambient temperature	-25 °C *) ... + 55 °C	
Protection class	II acc. to EN 60335-1	
Accuracy	type ± 1 s / day when +20 °C	
Power reserve	10 years ex works for +20 °C	
Shortest switching time	1 min	
Programmable	1 min	
Storage places	50	
Manual switch	Automatic/ pre-selection Fix ON/ Fix OFF	
Block formation of week days	Free assignment	
Display switch state	Yes	
Daylight saving time option	automatic/ free selection/ off	
Max. conductor cross section	4 mm ²	
Type of connection	Captive ± screw terminals	
Sealable	Yes	
Programming	Menu in 15 languages	

*) for limited display functions

Motor circuit breakers to be installed internally or externally, as MS or MA versions for a wide variety of applications e.g. in the wood, metal and plastic industry but also in the food production sector.

Extensive system accessories as well as transformer circuit breakers round off our product range.

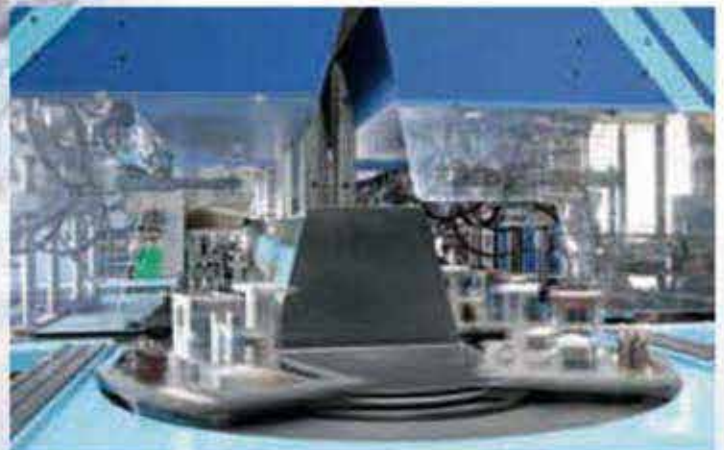

Alle Motorschutzschalter werden bereits in der Produktion bezüglich ihrer Isolationsfestigkeit und auf die hohen Anforderungen an ihre thermischen und elektromagnetischen Eigenschaften stückgeprüft.

Zusätzlich werden bestimmte Losgrößen aus dem Lager entnommen und in aufwändigen Stundentests im Labor unter genau definierten Bedingungen einzeln getestet.

So können wir den selbst auferlegten, hohen Qualitätsstandard von ABL SURSUM in allen Bereichen gewährleisten und Ihnen die Gewissheit geben, dass wertvolle Motoren optimal geschützt sind.

The MS motor protective circuit breakers offer optimal protection for motors and other loads up to 32 A, due to its high breaking capacity with strongly limited current.

They are equipped with phase failure sensitivity, isolating and main switch functions; 14 ranges are covering nominal rated currents from 0.1 up to 32 A. The MPCBs are self protected up to 6.3 A at 400 V. Ranges > 6.3 A provide a short circuit withstand rating of 6 kA. The MPCBs are temperature compensated; the actuating current of the short circuit trip is $12 \times I_n$.

The MS motor protective circuit breakers are VDE-tested and UL-approved.

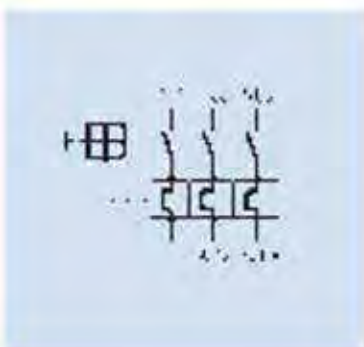
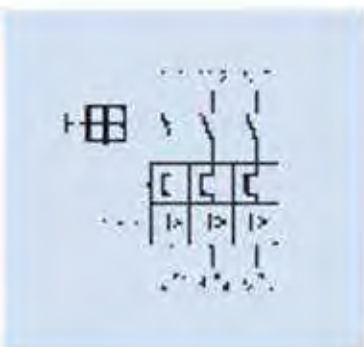

Rated current A	Max. rated operating power (kW/AC 3)			Operating current short circuit trip (A)	Article no.	Weight g/each	Packing unit
	400/415 V	500 V	690 V				

MS with overload and short circuit tripping							
Phase failure sensitivity							
0.1 - 0.16	-	-	0.06	1.92	MS016	250	1
0.16 - 0.25	0.06	0.06	0.12	3	MS025	250	1
0.25 - 0.4	0.09	0.12	0.18	4.8	MS04	250	1
0.4 - 0.63	0.12	0.18	0.25	7.6	MS063	250	1
0.63 - 1	0.25	0.37	0.55	12	MS1	250	1
1 - 1.6	0.55	0.75	1.1	19.2	MS1.6	250	1
1.6 - 2.5	0.75	1.1	1.5	30	MS2.5	250	1
2.5 - 4	1.5	2.2	3	48	MS4	250	1
4 - 6.3	2.2	3	4	75.6	MS6.3	250	1
6.3 - 10	4	5.5	7.5	120	MS10	250	1
10 - 16	7.5	9	12.5	192	MS16	250	1
16 - 20	9	12.5	15	240	MS20	250	1
20 - 25	12.5	15	22	300	MS25	250	1
25 - 32	15	18.5	-	384	MS32	250	1

BS with overload tripping only							
Phase failure sensitivity							
0.4 - 0.63	0.12	0.18	0.25		BS063	230	1
0.63 - 1	0.25	0.37	0.55		BS1	230	1
1 - 1.6	0.55	0.75	1.1		BS1.6	230	1
1.6 - 2.5	0.75	1.1	1.5		BS2.5	230	1
2.5 - 4	1.5	2.2	3		BS4	230	1
4 - 6.3	2.2	3	4		BS6.3	230	1
6.3 - 10	4	5.5	7.5		BS10	230	1
10 - 16	7.5	9	12.5		BS16	230	1
16 - 20	9	12.5	15		BS20	230	1
20 - 25	12.5	15	22		BS25	230	1
25 - 32	15	18.5	-		BS32	230	1

Rated current A	Max. rated operating power				Operating current short circuit trip (A)	Article no.	Weight g/each	Packing unit
	C_B 230 V 1500 ¹ /min	C_B 230 V 3000 ¹ /min	$C_A + C_B$ 230 V 1500 ¹ /min	$C_A + C_B$ 230 V 3000 ¹ /min				



MSH with integrated auxiliary contact 1NO for AC motors with overload and short circuit tripping

0.63 – 1	0.07	0.09	–	–	12	MSH1	220	1
1 – 1.6	0.12	0.12/0.18	0.12	0.18	19.2	MSH1.6	220	1
1.6 – 2.5	0.18	0.3	0.18/0.87	0.25	30	MSH2.5	220	1
2.5 – 4	0.22	0.5/0.55	0.37/0.5	0.37/0.66	48	MSH4	220	1
4 – 6.3	0.55/0.75	0.55/0.75	0.65	0.75/1.0	75.6	MSH6.3	220	1
6.3 – 10	1.0/1.3	1.1/1.3	1.0/1.3	1.0/1.3	120	MSH10	220	1
10 – 16	1.5 – 2.2	1.75	1.5	1.75	192	MSH16	220	1
16 – 20	–	–	–	–	240	MSH20	220	1

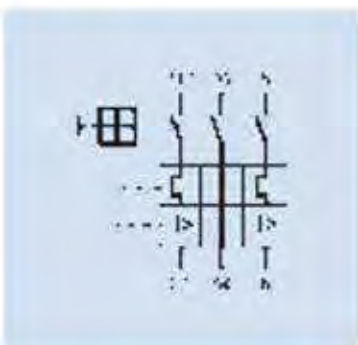

C_B with operating capacitor
 C_A with starting capacitor and C_B with operating capacitor



MSW for AC motors with overload and short circuit tripping

0.63 – 1	0.07	0.09	–	–	12	MSW1	210	1
1 – 1.6	0.12	0.12/0.18	0.12	0.18	19.2	MSW1.6	210	1
1.6 – 2.5	0.18	0.3	0.18/0.87	0.25	30	MSW2.5	210	1
2.5 – 4	0.22	0.5/0.55	0.37/0.5	0.37/0.66	48	MSW4	210	1
4 – 6.3	0.55/0.75	0.55/0.75	0.65	0.75/1.0	75.6	MSW6.3	210	1
6.3 – 10	1.0/1.3	1.1/1.3	1.0/1.3	1.0/1.3	120	MSW10	210	1
10 – 16	1.5 – 2.2	1.75	1.5	1.75	192	MSW16	210	1
16 – 20	–	–	–	–	240	MSW20	210	1

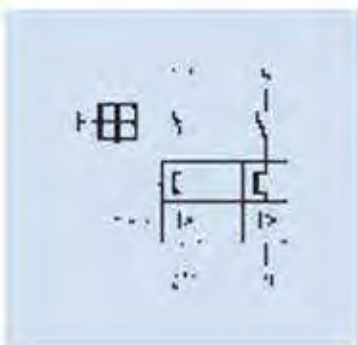

C_B with operating capacitor
 C_A with starting capacitor and C_B with operating capacitor

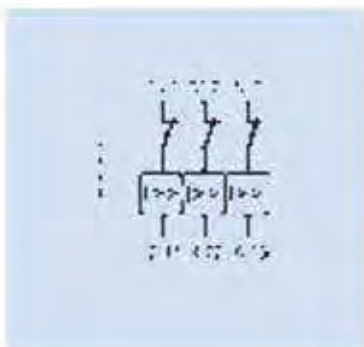

Rated uninter- rupted current (A)	Article no.	Weight g/each	Packing unit
Current limiter increasing the short circuit withstand rating of not inherent stable MPCBs up to 50 kA at 400 volts area			
32	SBMS32	175	1

Modules	Wiring diagram	Contacts	Article no.	Weight g/each	Packing unit
---------	----------------	----------	-------------	------------------	-----------------



Auxiliary contact for side mounting					
1/2 M		2 NO	HMS20	40	5
1/2 M		1 NO + 1 NC	HMS11	40	5
1/2 M		1 NO	HMS10	40	5
1/2 M		2 NC	HMS02	40	5
1/2 M		1 NC	HMS01	40	5



Early make auxiliary contact for side mounting					
1/2 M		1 NO + 1 NC	VHMS11	40	5
1/2 M		2 NO	VHMS20	40	5

Rated operating voltage	Article no.	Weight g/each	Packing unit
-------------------------	-------------	---------------	--------------

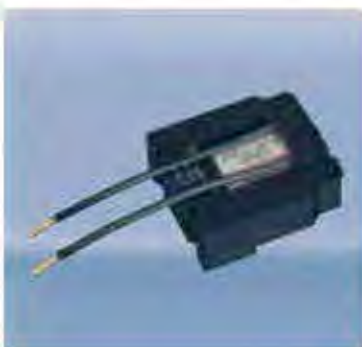

Shunt trip for inside mounting with connecting cable (140 mm long)			
110 V 50 Hz, 120 V 60 Hz	AMS110	75	10
220-230V 50 Hz, 240 V 60 Hz	AMS220	75	10
380-415 V 50 Hz, 440 V 60 Hz	AMS380	75	10
24 V 50/60 Hz	AMS24	75	10
500 V 50 Hz	AMS500	75	10
24 V DC	AMSD24	75	10
Pull-in voltage $0,7 \times U_e$		Switch in duration for U_e 100 % AC	

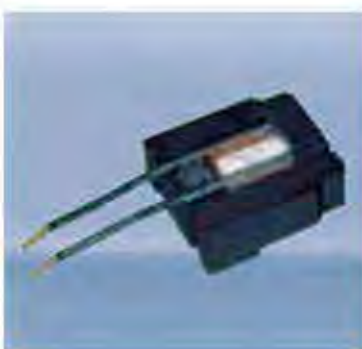
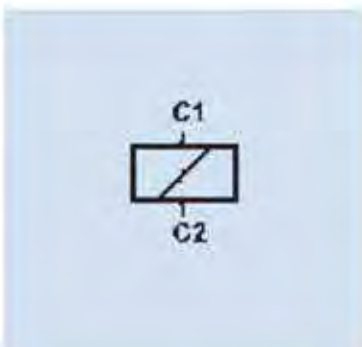

Undervoltage trip for inside mounting with connecting cable (140 mm long)			
110 V 50 Hz, 120 V 60 Hz	UMS110	75	10
220-230 V 50 Hz, 240 V 60 Hz	UMS220	75	10
380-415 V 50 Hz, 440 V 60 Hz	UMS380	75	10
24 V 50/60 Hz	UMS24	75	10
500 V 50 Hz	UMS500	75	10
Pull-in voltage $\geq 0,85 \times U_e$		Drop out voltage $0,35-0,7 \times U_e$	
Switch in duration for U_e 100%			

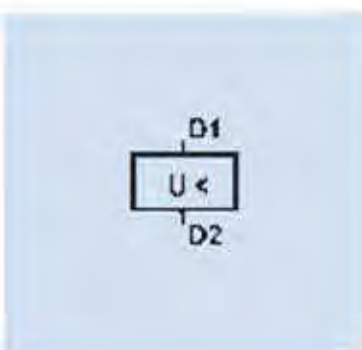



Stop button

not latching
red, on grey surface

	Article no.	Weight g/each	Packing unit
	MS.PT	55	5

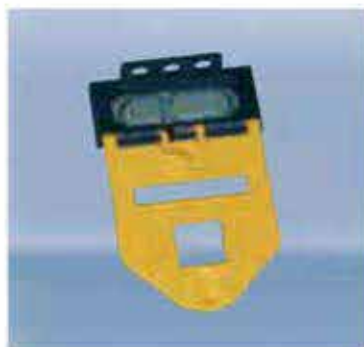

Padlocking facility

for up to three padlocks

	Article no.	Weight g/each	Packing unit
	MS.VS	100	10



Emergency-stop button

latching,
turn to release
red, on yellow surface

	Article no.	Weight g/each	Packing unit
	MS.PV	60	5



Kit IP55

to increase degree of protection from IP 41 to IP 55

	Article no.	Weight g/each	Packing unit
	MS.BS	25	10



Emergency-stop button

latching,
key release (2 keys)
red, on yellow surface

	Article no.	Weight g/each	Packing unit
	MS.PS2	65	5



N-Terminal

connecting of fifth conductor

	Article no.	Weight g/each	Packing unit
	MS.N	10	10



Indicator light

with glow bulb,
nominal rated voltage: 220 – 240 V

Farbe	Article no.	Weight g/each	Packing unit
transp.	MS.SLW2	10	5
green	MS.SLG2	10	5
red	MS.SLR2	10	5
yellow	MS.SLJ2	10	5



Indicator light

with glow bulb,
nominal rated voltage: 380 – 440 V

Farbe	Article no.	Weight g/each	Packing unit
transp.	MS.SLW3	10	5
green	MS.SLG3	10	5
red	MS.SLR3	10	5
yellow	MS.SLJ3	10	5

Standards	IEC 60947, DIN EN 60947, VDE 0660
Mechanical endurance = Electrical endurance	0,1 x 10 ⁶ switching cycles
Max. operating frequency	30 switching cycles / h
Ambient temperature not enclosed, max./min, enclosed, max./min.	+55 °C / -20 °C +40 °C / -20 °C
Resistance to mechanical shocks	15 g / 10 ms
Installation position	any, in IP 41 enclosure vertical
Cross section (1 or 2 conductors)	1,0 – 6 r; 0,75 – 4 f (with ferrule) 2 conductors differing by not more than 2 sizes
Torque for terminal screws - Main conductor - Auxiliary conductor - Auxiliary contact for front mounting	1,2 Nm 1,0 Nm 0,5 Nm
Rated impulse withstand voltage U_{imp}	6000 V
Overtoltage category / Pollution level	III / 3
Rated operating voltage U_0	690 V AC
Rated operating current I_n	0,16 – 32 A according to setting range
Frequenzy	40, 60 Hz
	At higher frequencies, the electromagnetic tripping values rise by a factor of about 1,1 at 100 Hz; 1,2 at 200 Hz; 1,4 at 400 Hz; 1,5 at 500 Hz
Utilization category (IEC 60947-4-1, DIN EN 60947-4-1, VDE 0660-102)	AC-3 max. 690 V
Temperature compensation (reference values to VDE / IEC)	-5 °C / +40 °C
Temperature compensation Operating range	-20 °C...+55 °C
Power loss in watt per path of current	by min. setting range 0,6 – 1,05 W / by max. setting range 1,5 – 2,6 W

Rated short circuit withstand rating I_{cu} MS IEC 60947-2, DIN EN 60947-2, VDE 0660-101						
Upper setting Thermal tripping	I_{cu} (kA)				Current limiter SBMS32 I_{cu} (kA)	
	230 V	400 V	500 V	690 V	230 V	400 V
0,16 – 1,6 A	No additional protective devices needed inherently stable for any selected short circuit currents				No additional protective devices needed inherently stable for any selected short circuit currents	
2,5 – 6,3 A			3	2,5		
10 A		8	3	2,5		50
16 – 32 A	10	6	2,5	2	100	50

Switching times at short circuit

minimum command time	2 ms
opening delay	2 ms
opening time	7 ms

Motor protective circuit breaker MS

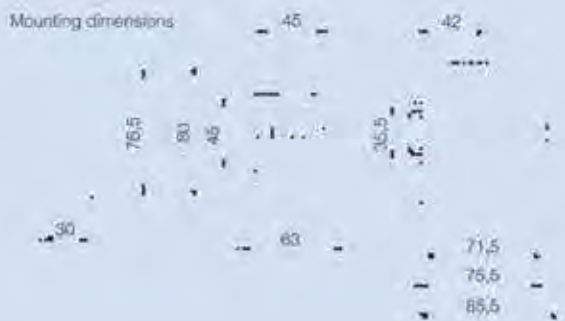

Current limiter SBMS32

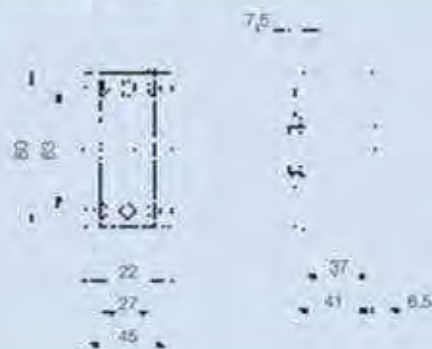

Insulated enclosure IP41 / IP55 MS.G41 / MS.G55

possible to integrate 1 MPCB and 2 side mounted auxiliary contacts

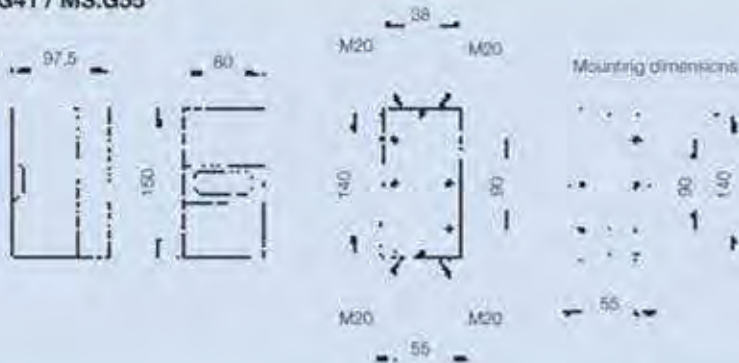

Insulated flush mounting enclosure MS.F41 / MS.F55

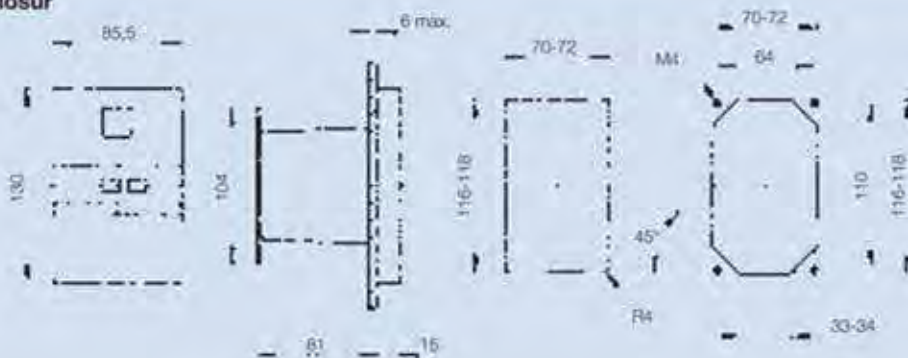

Insulated enclosure with CEE plug

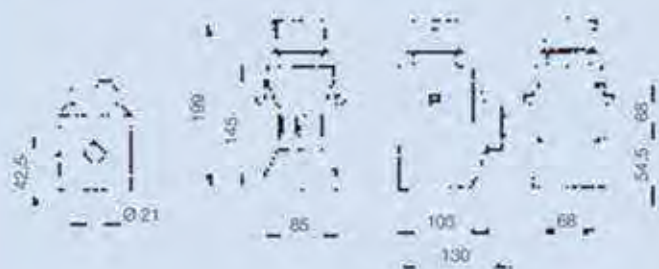

Emergency-stop button MS.PT - PS.PS2



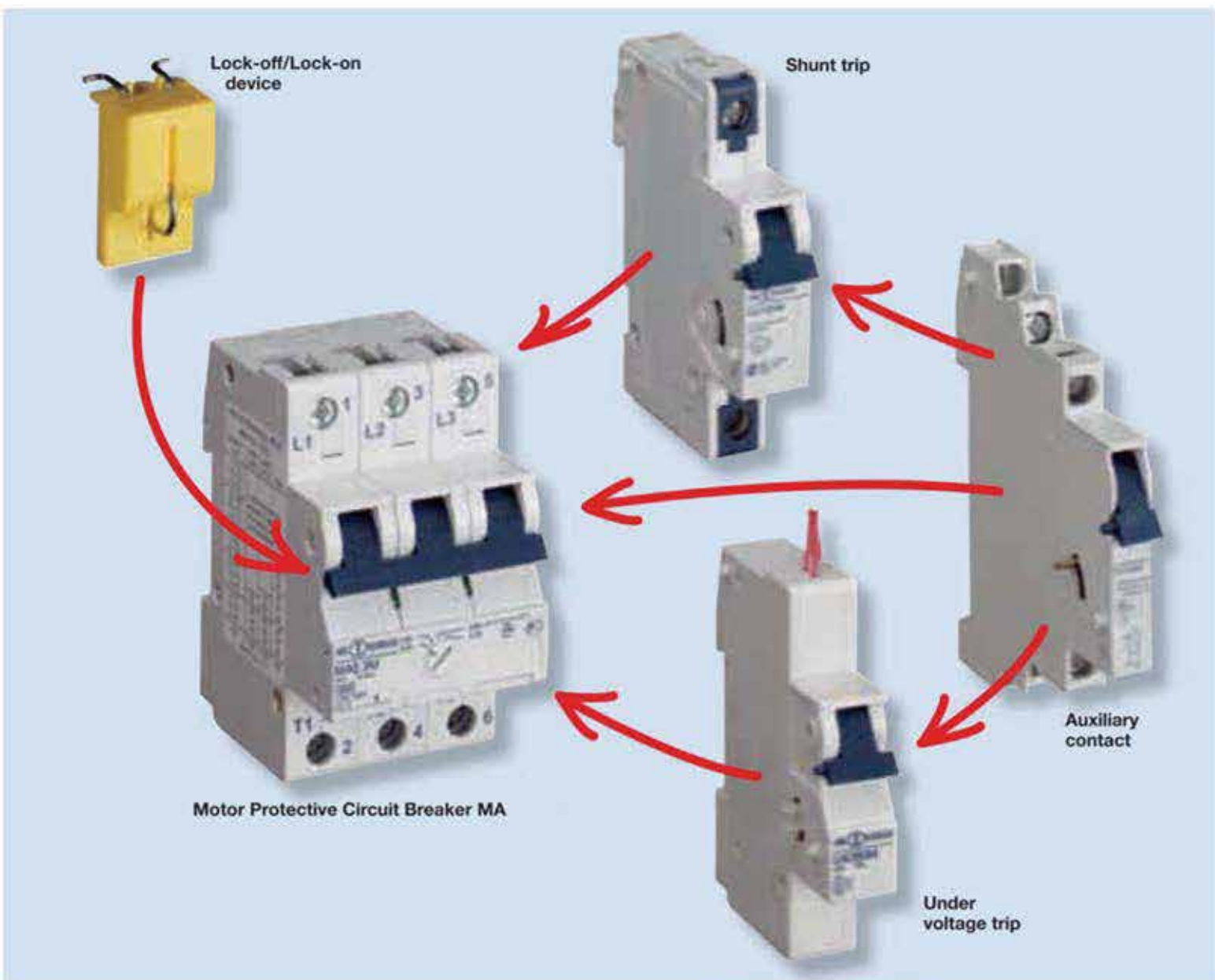

for UL miniature circuit breakers and motor protective circuit breakers MA



Shunt trip					
Module	Rated operating voltage	Max. operating current at U_n ($t < 10$ ms)	Article no.	Weight g/each	Packing unit
1	12 V =	1.3 A	FA12UM	105	5
1	24 V =	0.6 A	FA24UM	105	5
1	48 - 72 V =	0.2 A	FA48UM	105	5
1	110 - 240 V =, 415 V-	0.25 A at 110 V 0.5 A at 240 V 0.8 A at 415 V	FA110UM	105	5
Pull-in voltage $0.7 \times U_0$			Switch in duration for U_0 100%		



Undervoltage trip (50 Hz)					
Module	Rated voltage		Article no.	Weight g/each	Packing unit
1	24 V		UA24M	150	5
1	110 V		UA110M	150	5
1	220 V		UA220M	150	5
1	240 V		UA240M	150	5
1	380 V		UA380M	150	5
1	415 - 440 V		UA415M	150	5
Pull-in voltage $\geq 0.85 \times U_0$		Drop out voltage $0.35 - 0.7 \times U_0$		Switch in duration for U_0 100%	



Busbars							
Cross section (mm ²)	Busbar current Start of busbar/ Middle infeed	Modules/ Phases	Article no.	Weight g/each	Packing unit	Suitable end cape Article no.	
3 phase							
10	63/100	4/3	SB31210	84	25	SB.A1	
10	63/100	19/3	SB36010	420	20	SB.A1	
16	80/130	19/3	SB36016	675	20	SB.A2	
3 phase 3-pole circuit breaker + auxiliary contact							
16	80/130	16/3	SB36316	630	20	SB.A2	



Distance device 9 mm

Module	Article no.	Weight g/each	Packing unit
1/2	HDS	7	10



Lock-off/Lock-on device
For miniature circuit breakers and motor protective circuit breakers

Article no.	Weight g/each	Packing unit
EASS	4	10

Technical Data		
Standards	IEC 60947-2, DIN EN 60947-2, VDE 0660-101 IEC 60947-4-1, DIN EN 60947-4-1, VDE 0660-102 DIN VDE 0100, DIN VDE 0110, DIN VDE 0113	
Short circuit withstand rating	10 kA at 240/415 V~	
Utilization category	AC 3 at U_e 415 V~ (up to I_n 25 A)	
Max. back-up fuse	Fuse according to DIN-VDE 0636 100 A operating class gL for 240/415 V~ (only for $I_n > 10$ A)	
Rated voltage	500 V~ / 50-60 Hz	
Rated current range	15 setting ranges from 0,1 up to 40 A	
Rated uninterrupted current I_{cu}	40 A	
Tripping time at $6 \times I_n$	$> 5s/Tf$	
Test currents	Thermal not tripping I_1 (A) > 2 h	$1,05 \times I_n$
	Thermal tripping I_2 (A) < 2 h	$1,2 \times I_n$
	Electromagnetic not tripping I_4 (A) $> 0,1$ s	for the lower setting $16 \times I_n$ ($12,5 \times I_n > 16$ A) for the upper setting $10 \times I_n$
	Electromagnetic tripping I_5 (A) $< 0,1$ s	for the lower setting $19 \times I_n$ ($15 \times I_n > 16$ A) for the upper setting $12 \times I_n$
Temperature compensation	up to $+40^\circ$ C	
Permitted ambient temperature	open -20° C to $+50^\circ$ C, enclosure -20° C to $+40^\circ$ C storage/transport -40° C to $+70^\circ$ C	
Device depth according to DIN 43880	68 mm	
Mechanical endurance	30,000 switching cycles, (30,000 ON / 30,000 OFF)	
Permitted operating frequency	30 switching cycles/h	
Protection cover	Safe for fingers and back of hand acc. to DIN EN 50274, VDE 0660-514 BGV A2	
Degree of protection according to EN/IEC 60529	IP 20	
Installation position	Any	
Mounting	On din-rail acc. to DIN EN 60715 35 mm	
Lockability	The handle can be secured against manual switching in the on and off position by a lead seal	
Climatic resistance	Humid heat constant according to DIN IEC 60068-2 - 78 Humid heat cyclic according to DIN EN 60068-2 - 30	
Vibration resistance	> 15 g according to DIN EN 60068-2 - 59 for a load with I_1	
Resistance to mechanical shocks	25 g 11 ms	

Internal resistance per pole in mΩ and power loss in Watt of the complete device

Type	Lower setting	Upper setting	Internal resistance per pole mΩ	Power loss for the complete device for	
	A	A		lower setting Watt	upper setting Watt
MA016M	0.10	0.16	85500	2.6	6.6
MA025M	0.16	0.25	35000	2.7	6.6
MA040M	0.25	0.40	15000	2.8	7.2
MA063M	0.40	0.63	5200	2.5	6.2
MA1.0M	0.63	1.0	2300	2.7	6.9
MA1.6M	1.0	1.6	950	2.9	7.3
MA2.5M	1.6	2.5	355	2.7	6.7
MA4.0M	2.5	4.0	142	2.7	6.8
MA6.3M	4.0	6.3	54	2.6	6.4
MA10M	6.3	10	28	3.3	8.4
MA16M	10	16	13.9	4.2	10.7
MA20M	16	20	9.9	7.6	11.9
MA25M	20	25	6.3	7.6	11.8
MA32M	25	32	3.85	7.2	11.8
MA40M	32	40	3.1	9.5	14.9

Rated currents (A)	Rated short circuit withstand rating I_{cu} according to IEC 60947-2, DIN EN 60947-2			Back-up protection if the short circuit current exceeds the short circuit withstand rating Back-up fuse (gL, aM) A if $I_{sc} > I_{cn}$		
	230 V	I_{cu} (kA) 400 V	500 V	230 V	400 V	500 V
0.1 - 0.16						
0.16 - 0.25	No additional protective devices needed			No back-up fuse necessary		
0.25 - 0.4	inherently stable for any selected short circuit currents			inherently stable for any selected short circuit currents		
0.4 - 0.63						
0.63 - 1						
1 - 1.6						
1.6 - 2.5						
2.5 - 4			6			63
4 - 6.3			6			63
6.3 - 10			6			80
10 - 16		10	6		100	80
16 - 20	15	10	6	100	100	80
20 - 25	15	10	6	100	100	80
25 - 32	15	10	6	100	100	80
32 - 40	15	10	6	100	100	80

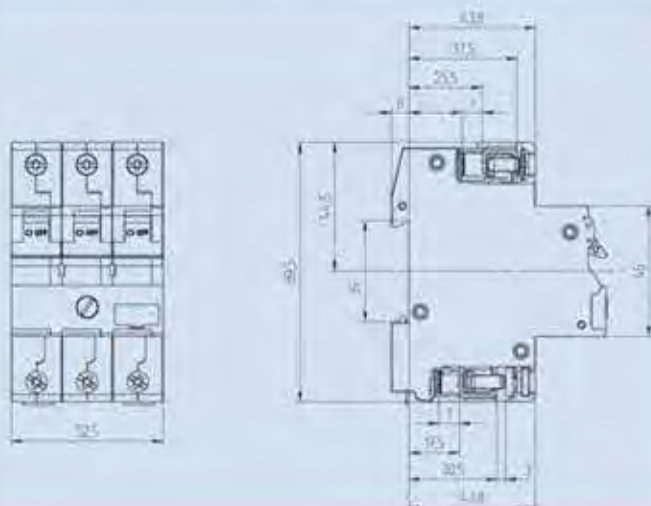

according to UL 508 und CSA-22.2 Nr.14 for
UL miniature circuit breakers and motor protective
circuit breakers MA



Auxiliary contact					
Module	Type of contact	Contacts	Article no.	Weight g/each	Packing unit
1/2	1 auxiliary contact	1NO	H10UM	35	10
1/2	2 auxiliary contacts	1NO + 1NC	H11UM	40	10
1/2	3 auxiliary contacts	1NO + 2NC	H12UM	45	10
1/2	3 auxiliary contacts	2NO + 1NC	H21UM	45	10

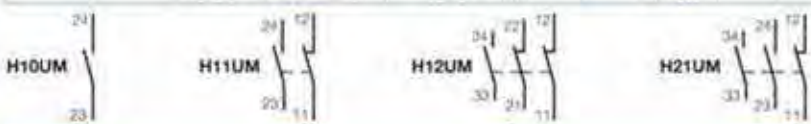

Shunt trip					
Module	Rated operating-voltage	Max. operating current at U_n ($t < 10$ ms)	Article no.	Weight g/each	Packing unit
1	12 V-	1,3 A	FA12UM	105	5
1	24V-	0,6 A	FA24UM	105	5
1	48 - 74 V -	0,2 A	FA48UM	105	5
1	110 - 240 V -, 415 V-	0,25 A bei 110 V 0,5 A bei 240 V 0,8 A bei 415 V	FA110UM	105	5



Undervoltage trip (60 Hz)					
Module	Rated Voltage		Article no.	Weight g/each	Packing unit
1	120 V		UA120UM	150	5
1	220 V		UA220UM	150	5

Pull-in voltage $\geq 0.85 \times U_n$ Drop-out voltage $0.35 - 0.7 \times U_n$ Switch-on duration for U_n 100%



Regardless of whether you are in the middle of new construction, renovation or extension, the expansion of an existing building or the renovation and modernisation of an older building or company – there is a suitable ABL SURSUM distribution board for every project.

We offer surface-mounting, flush-mounting, and hollow-wall variants in different sizes.

If you want to install e.g. indicator lamps, distribution boards with transparent doors of high-quality, blue plastic material are available. In addition, we have an extensive accessory range available, and you have the opportunity to clearly and durably label your fixtures with our pictoplan labelling program (see page 25).

Seite



Naturally we care about how practical our products are for fitters:

Large wiring spaces, easy installation and ruggedness of housing are the most important characteristics of our distribution board range. And to help you carry out your work as quickly as possible, you can opt for screwless terminal strips.



Patented cable entry

Our patented, self-latching sliding section with automatically retractable comb pins makes cable-laying easy. We save you the usual difficult punching out or cutting out of the cable entries. It's faster and also looks good.

Distribution Boards

according to DIN 43871, DIN VDE 0603 and EN 60439

Device support:

- mounting with steel quick-release screws
- ideal for large projects due to pre-mounting in the workshop
- lateral moulded cable duct
- adjustable in the wall box through oblong holes

Masking frame / door:

- from electroplated sheet steel
- lacquered in RAL 9010 pure white, free of lead and cadmium
- door can be hinged on either side, door can be opened from the left or right
- adjustment to plaster surface up to 22 mm
- large door-opening angle 180°



Easy installation:

large wiring spaces and additional space under the DIN rails.

Protection cover: snap-on mounting.

Tolerance adjustment on the device sections through membranes. Can also be taken off when the distribution board door is mounted.

Patented door handle:

- tilt-handle with retaining spring and locking technology
- lock with 19 different closures can be installed in a hidden position
- very fast lock installation



according to DIN 43871, DIN VDE 0603 and EN 60439
for installing 68 mm installation devices, In 63 A, IP 30

Surface mounted distribution boards

The totally insulated thermoplastic distribution board range in the colour RAL 9010 covers 1 to 4-row distribution boards for the installation of 68 mm installation devices.

The device support is closed at the back and enables wiring access not only from all sides but also by breaking open the rear panel from behind. The cover is mounted on the device support with quick-release screws.



Surface mounted distribution boards

1 row
with N and PE terminals
Dimensions: 275 x 221 x 74 mm

Colour	Article no.	Weight g/each	Packing unit
blue	AV12	732	1



Surface mounted distribution boards

2 rows
with N and PE terminals
Dimensions: 275 x 346 x 74 mm

Colour	Article no.	Weight g/each	Packing unit
white	AV24	1038	1



Surface mounted distribution boards

3 rows
with N and PE terminals
Dimensions: 275 x 491 x 74 mm

Colour	Article no.	Weight g/each	Packing unit
white	AV36	1385	1



Surface mounted distribution boards

4 rows
with N and PE terminals
Dimensions: 275 x 616 x 74 mm

Colour	Article no.	Weight g/each	Packing unit
white	AV48	1778	1

Surface mounted distribution boards with doors

The totally insulated thermoplastic distribution board range in the colour RAL 9010 covers 1 to 3-row distribution boards for the installation of 68 mm installation devices.



Surface mounted distribution boards with doors

1 row
with N and PE terminals
Dimensions: 275 x 221 x 103 mm

Colour	Article no.	Weight g/each	Packing unit
blue	AV12TB	962	1
white	AV12T	962	1



Surface mounted distribution boards with doors

2 rows
with N and PE terminals
Dimensions: 275 x 346 x 103 mm

Colour	Article no.	Weight g/each	Packing unit
blue	AV24TB	1378	1
white	AV24T	1378	1



Surface mounted distribution boards with doors

3 rows
with N and PE terminals
Dimensions: 275 x 491 x 103 mm

Colour	Article no.	Weight g/each	Packing unit
blue	AV36TB	1905	1
white	AV36T	1905	1



Complete door for surface mounted distribution boards

1 row TAV1 / TAV1B
2 rows TAV2 / TAV2B
3 rows TAV3 / TAV3B

Colour	Article no.	Weight g/each	Packing unit
blue	TAV1B	230	1
	TAV2B	340	1
	TAV3B	520	1
white	TAV1	230	1
	TAV2	340	1
	TAV3	520	1



Transparent window for surface mounted distribution boards

T1 – with frame to be snapped into the device section

TP1 – with frame to be snapped into the device section, sealable

Colour	Article no.	Weight g/each	Packing unit
white	T1	127	1
white	TP1	132	1

Special Distribution Boards



Surface mounted enclosure

for 2 modules
Dimensions: 46 x 145 x 58,5 mm

Colour	Article no.	Weight g/each	Packing unit
grey	IKV.2	87	10



Housing

Splash-proof IP 44
with DIN rail
for 5 modules
Dimensions: 118 x 170 x 131 mm

Colour	Article no.	Weight g/each	Packing unit
grey	B 40.01	510	1



Surface mounted enclosure

for 4 modules
without terminals
Dimensions: 82 x 145 x 58,5 mm

Colour	Article no.	Weight g/each	Packing unit
grey	IKV.4	110	5



Surface mounted enclosure

for 3 modules
with N and PE terminals
Dimensions: 82 x 145 x 58,5 mm

Colour	Article no.	Weight g/each	Packing unit
grey	IKV.4N1	110	5



Surface mounted enclosure

for 10 modules
without terminals
Dimensions: 200 x 145 x 58,5 mm

Colour	Article no.	Weight g/each	Packing unit
grey	IKV10	300	2



Surface mounted enclosure

for 10 modules
with N and PE terminals
Dimensions: 200 x 145 x 58,5 mm

Colour	Article no.	Weight g/each	Packing unit
grey	IKV10N1	300	2

The product range of ABL SURSUM



Regardless of whether you need building installation, industrial installation, switchgear manufacturing or cable pre-assembly: Whatever you need, you can be sure that you will find the right solution in our extensive range of approx. 7,000 products.

If you need a specific solution, let us know – our experts will find it!



Floor socket outlets

Rooms are more and more often planned down to the smallest detail. Our exclusive Design socket outlets are made from cast-aluminium-bronze and fit ideally into all sophisticated office and living quarters and come in different sizes and colours.

We also supply floor socket outlets in die-cast aluminium.



SCHUKO plug connections

Naturally, the inventor of the SCHUKO system has a large selection of SCHUKO plug connections in its product range. This range of products is actually so extensive that even experts are constantly surprised!



Outlet boxes

If safe connection conditions are required for large household appliances, then the outlet boxes from ABL SURSUM are just what you need. Quickly wired with screwless terminals and easy-to-install with large wiring spaces. They can be partially retrofitted for a second connecting cable or ready for the future by the use of a three-chamber outlet box. If not much space is available, use our extra flat version. For especially thick input leads, the outlet box with 6 mm² terminals is what you want. And, of course, the different versions are available for both surface mounting and flush mounting.



The most innovative electrotechnology for caravans and boats

Infeed sockets, multi-function outlets for electricity and TV/ satellite reception, fresh water connections and diesel filling connections, electricity distribution boxes, adapters, plugs and connectors, socket outlet cases or strips, but also lighting scene controls for boats and caravans ...

our product range is as varied as the requirements in this area!



Describing a product range of over 7,000 articles would go beyond the scope of this publication.

Detailed information can be found at:
www.abl-sursum.com



2009/10



Switching Devices

From conception to delivery

We are oriented towards the requirements of the national and international markets and the desires of our customers which we approach passionately with a wealth of ideas, engineering skills and the power of innovation.



Location:
Innovative products from Lauf

With a wide range of more than 7,000 products, the traditional Franconian company ABL SURSUM delivers to markets all around the world.

We are available for you – wherever you are

International representatives:

Egypt	Mexico
Argentina	New Zealand
Azerbaijan	Russia
Bolivia	Singapore
Bosnia Herzegovina	South Africa
Chile	Taiwan
China	Thailand
Georgia	Ukraine
India	USA
Iceland	Venezuela
Canada	United Arab Emirates
Croatia	Vietnam
Morocco	Belarus



Decisive advantages – combined in one product range

In this generation of miniature circuit breakers, all the decisive advantages are implemented consistently and with a view to capacity. Even today, they are focussed on the requirements of modern installation technology and designed for tomorrow's markets.

The result is three product ranges combining innovation and efficiency, flexibility and functionality as well as safety and speed – for a multitude of application and installation solutions.

We have consistently implemented the increased requirements. The three new product ranges are tailored to supply various needs:

The S Range

The installation-friendly 6-kA miniature circuit breakers for house installations.

The SL Range

The innovative 6 kA miniature circuit breakers with screwless top terminal for fast mounting.

The T Range

The flexible 10 kA miniature circuit breakers for industry applications on the highest level.



**More space for wiring –
when size is decisive**

2 Compact design

- Minimum dimensions – with an installation height of 82.5 mm, one of the smallest miniature circuit breakers on the market
- Maximum saving of space for comfortable wiring

Compact dimensions

At ABL SURSUM, we know that there is little space for wiring in a small installation distribution board. Every millimetre counts and creates advantages when installing. Therefore, our miniature circuit breakers have a particularly compact design.

With an installation height of only 82.5 mm, they rank among the smallest devices on the market. Thus a significantly larger wiring space is available. The extended installation space allows for easy, comfortable and thus quick installation or removal.

A clear advantage for more convenient mounting.

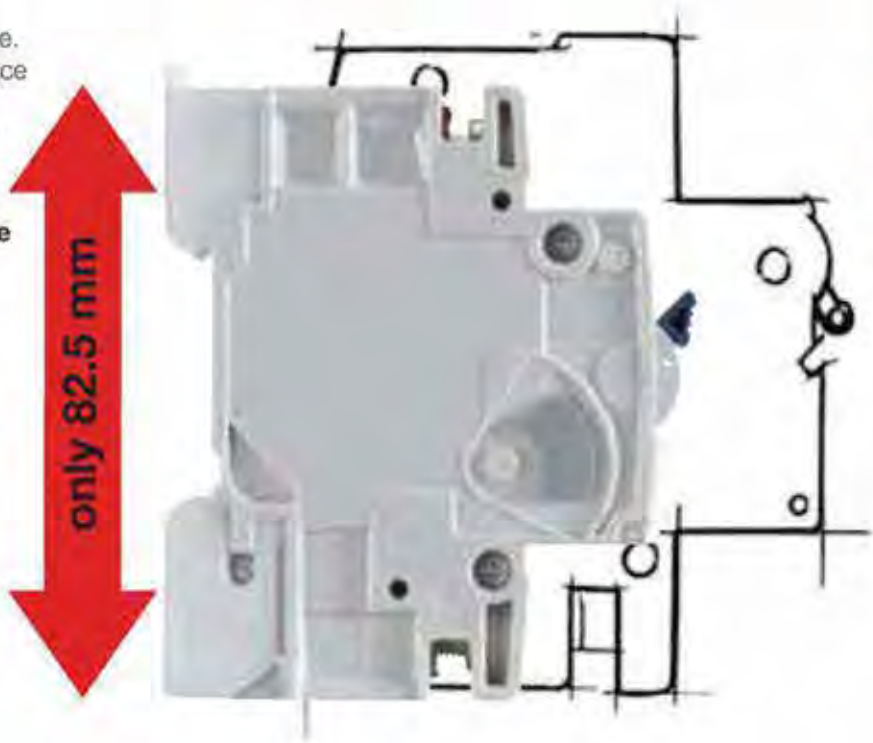
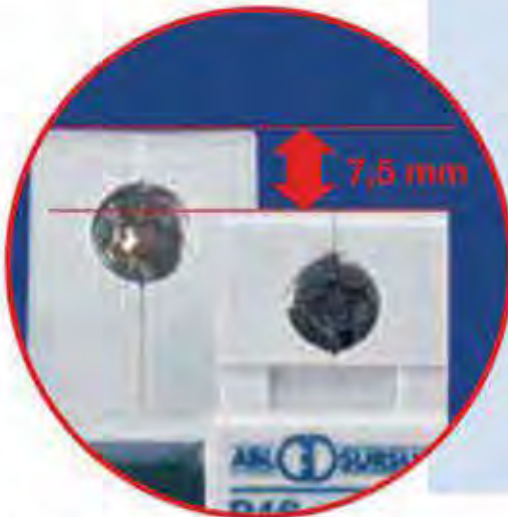

Speed and safety – screwless clamping technology

4 Screwless clamping technology

- Innovative, screwless connection technology "plug2power"
- Quick mounting – easy removal
- Highest wiring safety
- Extreme tensile load capacity
- Integrated test opening for voltage measurement

Quicker installation with "plug2power"

In present-day installation technology, saving time is an important competitive advantage. Our innovative, screwless clamping technology "plug2power" makes this time saving possible.

For "plug2power" connections, the screw terminal at the upper output is replaced by a plug terminal with particularly high clamping force

Safer installation with "plug2power"

Of course, our ABL SURSUM "plug2power" plug terminals are absolutely safe. In addition, their tensile load capacity is high and they are maintenance-free. Due to their special design, the terminals even allow higher tensile loads than screw terminals. An involuntary release is practically impossible due to the self-correcting forces of the tension spring

A clear advantage for more safety.

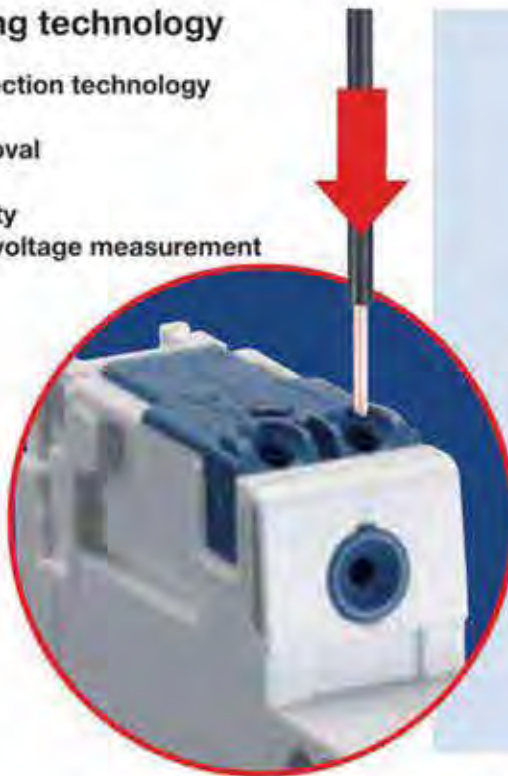

plug2power



Connectable conductor cross sections SL product range		
Screwless terminal top *		
Type of conductor	max.	min.
Single wire	4 mm ²	1 mm ²
Multiple wire	4 mm ²	1,5 mm ²
Fine wire	4 mm ²	1 mm ²

*Stripped length 12 - 14 mm

We have also considered the details for our "plug2power" technology: Measuring the voltage and releasing the connected conductor with a screwdriver through the practical measuring opening.



Quality und innovation

8 Highest quality

- Decades of experience and electro-technical expertise
- Consistent quality management without any compromises in the entire production cycle
- Tested three times and independently
- Optimum long-life cycle

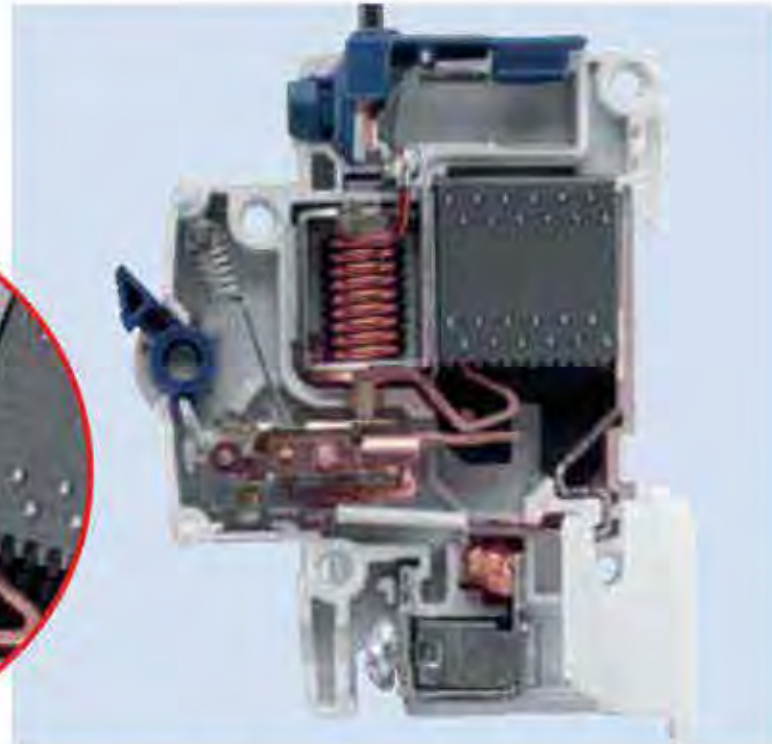

Quality must be developed
 Miniature circuit breakers have an extremely important protection function. That is why the highest quality ranks first at ABL SURSUM. And this applies to all ABL SURSUM products, without restrictions, for we do not accept any compromises in this important issue. ABL SURSUM miniature circuit breakers were tested three times during development: First, in numerous development tests; then, during approval testing and application testing.

Quality must be tested
 At ABL SURSUM, product testing has a huge significance. Every single miniature circuit breaker is thermally and electromagnetically tested in a modern automatic testing machine before it is delivered. In a high-voltage test, an insulation test is carried out in the mounting position. A laborious test method each of our products must pass without any errors.



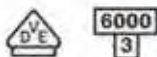

Rated current I_n A	Characteristic		Weight g/each	Packing unit
	B Article no.	C Article no.		



1-pole				
1		C1S1	120	12
2		C2S1	120	12
3		C3S1	120	12
4		C4S1	120	12
5		C5S1	120	12
6	B6S1	C6S1	120	12
10	B10S1	C10S1	120	12
13	B13S1	C13S1	120	12
16	B16S1	C16S1	120	12
20	B20S1	C20S1	120	12
25	B25S1	C25S1	120	12
32	B32S1	C32S1	120	12
40	B40S1	C40S1	125	12
50	B50S1	C50S1	135	12
63	B63S1	C63S1	135	12



3-pole				
1		C1S3	360	4
2		C2S3	360	4
3		C3S3	360	4
4		C4S3	360	4
5		C5S3	360	4
6	B6S3	C6S3	360	4
10	B10S3	C10S3	360	4
13	B13S3	C13S3	360	4
16	B16S3	C16S3	360	4
20	B20S3	C20S3	360	4
25	B25S3	C25S3	360	4
32	B32S3	C32S3	360	4
40	B40S3	C40S3	375	4
50	B50S3	C50S3	405	4
63	B63S3	C63S3	405	4



10 kA B, C and D characteristic acc. to IEC 60898-1, DIN EN 60898-1, VDE 0641-11
10 kA K and Z characteristic acc. to IEC 60947-2, DIN EN 60947-2, VDE 0660-101

This product range differentiates between:

- Standard products for normal market applications (shown in the table in bold – delivery time approx. 2 weeks)
- Exclusive products for sector-specific applications (shown in the table in normal print – longer delivery time)

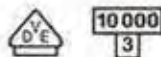

Rated current I_n A	B Article no.	C Article no.	Characteristic D Article no.	K Article no.	Z Article no.	Weight g/each	Packing unit
--------------------------	------------------	------------------	------------------------------------	------------------	------------------	------------------	-----------------



Also available:
Miniature circuit breakers with a CB
certificate in 80A / 100A / 125A type –
however, these have a different design
Only approved as an export version!!

1-pole							
0.3		C0.3T1	D0.3T1	K0.3T1	Z0.3T1	120	12
0.5		C0.5T1	D0.5T1	K0.5T1	Z0.5T1	120	12
0.8		C0.8T1	D0.8T1	K0.8T1	Z0.8T1	120	12
1	B1T1	C1T1	D1T1	K1T1	Z1T1	120	12
1.6		C1.6T1	D1.6T1	K1.6T1	Z1.6T1	120	12
2	B2T1	C2T1	D2T1	K2T1	Z2T1	120	12
2.5		C2.5T1	D2.5T1	K2.5T1	Z2.5T1	120	12
3	B3T1	C3T1	D3T1	K3T1	Z3T1	120	12
3.5		C3.5T1	D3.5T1	K3.5T1	Z3.5T1	120	12
4	B4T1	C4T1	D4T1	K4T1	Z4T1	120	12
5	B5T1	C5T1	D5T1	K5T1	Z5T1	120	12
6	B6T1	C6T1	D6T1	K6T1	Z6T1	120	12
8		C8T1	D8T1	K8T1	Z8T1	120	12
10	B10T1	C10T1	D10T1	K10T1	Z10T1	120	12
13	B13T1	C13T1	D13T1	K13T1	Z13T1	120	12
16	B16T1	C16T1	D16T1	K16T1	Z16T1	120	12
20	B20T1	C20T1	D20T1	K20T1	Z20T1	120	12
25	B25T1	C25T1	D25T1	K25T1	Z25T1	120	12
32	B32T1	C32T1	D32T1	K32T1	Z32T1	120	12
40	B40T1	C40T1	D40T1	K40T1		125	12
50	B50T1	C50T1	D50T1	K50T1		135	12
63	B63T1	C63T1	D63T1	K63T1		135	12



1-pole with switched neutral							
0.3		C0.3T8	D0.3T8	K0.3T8		240	6
0.5		C0.5T8	D0.5T8	K0.5T8		240	6
0.8		C0.8T8	D0.8T8	K0.8T8		240	6
1	B1T8	C1T8	D1T8	K1T8		240	6
1.6		C1.6T8	D1.6T8	K1.6T8		240	6
2	B2T8	C2T8	D2T8	K2T8		240	6
2.5		C2.5T8	D2.5T8	K2.5T8		240	6
3	B3T8	C3T8	D3T8	K3T8		240	6
3.5		C3.5T8	D3.5T8	K3.5T8		240	6
4	B4T8	C4T8	D4T8	K4T8		240	6
5	B5T8	C5T8	D5T8	K5T8		240	6
6	B6T8	C6T8	D6T8	K6T8		240	6
8		C8T8	D8T8	K8T8		240	6
10	B10T8	C10T8	D10T8	K10T8		240	6
13	B13T8	C13T8	D13T8	K13T8		240	6
16	B16T8	C16T8	D16T8	K16T8		240	6
20	B20T8	C20T8	D20T8	K20T8		240	6
25	B25T8	C25T8	D25T8	K25T8		240	6
32	B32T8	C32T8	D32T8	K32T8		240	6
40	B40T8	C40T8	D40T8	K40T8		250	6
50	B50T8	C50T8	D50T8	K50T8		270	6
63	B63T8	C63T8	D63T8	K63T8		270	6

Additional performance features of the T product range – rated switching capacity according to IEC 60947-2, DIN EN 60947-2

Tripping characteristic	B, C, D, K, Z		
1-pole	0.3 - 40 A	254/440 V	10 kA
2-pole / 3-pole	0.3 - 40 A	440 V	10 kA
Tripping characteristic	B, C		
1-pole	0.3 - 20 A	230/400 V	20 kA

Conductor cross sections product ranges S and T

Type of conductor *)	Box terminal bottom		Box terminal top	
	max.	min.	max.	min.
Single wire	35 mm ²	0.5 mm ²	25 mm ²	0.5 mm ²
Multiple wire	35 mm ²	1.5 mm ²	25 mm ²	1.5 mm ²
Stranded wire	25 mm ²	1 mm ²	16 mm ²	1 mm ²
Stranded wire with ferrule	16 mm ²	0.5 mm ²	16 mm ²	0.5 mm ²
Busbar cable lug	Up to 3 mm thickness		Up to 3 mm thickness	
Combined, connector and busbar or cable lug	Up to 35 mm ² and up to 2 mm thickness		Up to 25 mm ² and up to 2 mm thickness	
Torque	max. 2.5 Nm			

Conductor cross sections SL product range

Type of conductor *)	Box terminal bottom		Screwless terminal top	
	max.	min.	max.	min.
Single wire	35 mm ²	0.5 mm ²	4 mm ²	1 mm ²
Multiple wire	35 mm ²	1.5 mm ²	4 mm ²	1.5 mm ²
Stranded wire	25 mm ²	1 mm ²	4 mm ²	1 mm ²
Stranded wire with ferrule	16 mm ²	0.5 mm ²	2.5 mm ²	1 mm ²
Busbar cable lug	Up to 3 mm thickness		-	
Combined, connector and busbar or cable lug	Up to 35 mm ² and up to 2 mm thickness		-	
Torque	max. 2.5 Nm		-	

*) Stripped length 12 - 14 mm

The following tripping characteristics can be chosen:

- B characteristic for wiring protection
- C characteristic for device protection with higher starting current inrush
- D characteristic for the protection of power circuits, motors and transformers
- K characteristic for the protection of power circuits, motors and transformers
- Z characteristic for semiconductor protection at high impedances

No. of Poles	S Range		SL Range		T Range					
	1	3	1	3	1	2	3	4	1+N	3+N
B-characteristic	●	●	●	●	●	●	●	●	●	●
C-characteristic	●	●	●	●	●	●	●	●	●	●
D-characteristic					●	●	●	●	●	●
K-characteristic					●	●	●	●	●	●
Z-characteristic					●	●	●			
	↓		↓		↓					
	Standard products		Standard products		Standard products Exclusive products System products					

Internal resistances in mOhm and power losses in Watt per pole (at I_n)

Rated current I_n (A)	B-characteristic		C-characteristic		D-characteristic		K-characteristic		Z-characteristic	
	Internal resistance mOhm	Power loss Watt	Internal resistance mOhm	Power loss Watt	Internal resistance mOhm	Power loss Watt	Internal resistance mOhm	Power loss Watt	Internal resistance mOhm	Power loss Watt
0.3	-	-	16600	1.5	16600.0	1.5	16860.0	1.5	31500.0	2.8
0.5	-	-	6850	1.7	6850.0	1.7	6850.0	1.7	10250.0	2.6
0.8	-	-	3050	2.0	3050.0	2.0	3050.0	2.0	5150.0	3.3
1	1950	2.0	1750	1.8	1750.0	1.8	1750.0	1.8	2690.0	2.7
1.6	720	1.8	590	1.5	590.0	1.5	590.0	1.5	940.0	2.4
2	510	2.0	420	1.7	420.0	1.7	420.0	1.7	690.0	2.8
2.5	325	2.0	295	1.8	295.0	1.8	295.0	1.8	430.0	2.7
3	211	1.9	200	1.8	173.0	1.6	200.0	1.8	345.0	3.1
3.5	159	1.9	125	1.5	125.0	1.5	125.0	1.5	225.0	2.8
4	131	2.1	109	1.7	105.0	1.7	109.0	1.7	225.0	3.6
5	85	2.1	61.6	1.5	61.6	1.5	65.4	1.6	105.0	2.6
6	52.9	1.9	49.1	1.8	45.9	1.7	49.1	1.8	82.3	3.0
8	26	1.7	24	1.5	20.7	1.3	44.0	2.8	37.1	2.4
10	13.4	1.3	13.4	1.3	13.4	1.3	31.5	3.1	27.8	2.8
13	11.3	1.9	8.04	1.4	8.1	1.4	8.8	1.5	15.1	2.6
16	8.04	2.1	8.04	2.1	8.1	2.1	7.5	1.9	11.3	2.9
20	7.1	2.8	7.45	3.0	6.4	2.5	6.3	2.5	7.4	3.0
25	5	3.1	5	3.1	4.1	2.5	4.7	2.9	5.8	3.7
32	3.6	3.7	3.6	3.7	2.7	2.8	2.8	2.9	3.6	3.7
40	2.2	3.5	2.2	3.5	2.2	3.5	2.2	3.5	-	-
50	1.95	4.9	1.9	4.8	1.8	4.6	2.0	4.9	-	-
63	1.77	7.0	1.77	7.0	1.7	6.8	1.8	7.0	-	-

Overload and short circuit currents

I_n (A)	Overload						Short circuit									
	B, C, D		K		Z		B		C		D		K		Z	
	I_1	I_2	I_1	I_2	I_1	I_2	I_4	I_5	I_4	I_5	I_4	I_5	I_4	I_5	I_4	I_5
0.3	0.339	0.435	0.315	0.360	0.315	0.405	0.9	1.5	1.5	3	3	6	2.4	3.6	0.6	0.9
0.5	0.565	0.725	0.525	0.600	0.525	0.675	1.5	2.5	2.5	5	5	10	4	6	1	1.5
0.75	0.848	1.088	0.788	0.900	0.788	1.013	2.25	3.75	3.75	7.5	7.5	15	6	9	1.5	2.25
1	1.13	1.45	1.05	1.20	1.05	1.35	3	5	5	10	10	20	8	12	2	3
1.6	1.81	2.32	1.68	1.92	1.68	2.16	4.8	8	8	16	16	32	12.8	19.2	3.2	4.8
2	2.26	2.90	2.10	2.40	2.10	2.70	6	10	10	20	20	40	16	24	4	6
2.5	2.83	3.63	2.63	3.00	2.63	3.38	7.5	12.5	12.5	25	25	50	20	30	5	7.5
3	3.39	4.35	3.15	3.60	3.15	4.05	9	15	15	30	30	60	24	36	6	9
3.5	3.96	5.08	3.68	4.20	3.68	4.73	10.5	17.5	17.5	35	35	70	28	42	7	10.5
4	4.52	5.80	4.20	4.80	4.20	5.40	12	20	20	40	40	80	32	48	8	12
5	5.65	7.25	5.25	6.00	5.25	6.75	15	25	25	50	50	100	40	60	10	15
6	6.78	8.70	6.30	7.20	6.30	8.10	18	30	30	60	60	120	48	72	12	18
8	9.04	11.60	8.40	9.60	8.40	10.80	24	40	40	80	80	160	64	96	16	24
10	11.3	14.5	10.5	12.0	10.5	13.5	30	50	50	100	100	200	80	120	20	30
13	14.7	18.9	13.7	15.6	13.7	17.6	39	65	65	130	130	260	104	156	26	39
16	18.1	23.2	16.8	19.2	16.8	21.6	48	80	80	160	160	320	128	192	32	48
20	22.6	29.0	21.0	24.0	21.0	27.0	60	100	100	200	200	400	160	240	40	60
25	28.3	36.3	26.3	30.0	26.3	33.8	75	125	125	250	250	500	200	300	50	75
32	36.2	46.4	33.6	38.4	33.6	43.2	96	160	160	320	320	640	256	384	64	96
40	45.2	58.0	42.0	48.0	-	-	120	200	200	400	400	800	320	480	-	-
50	56.5	72.5	52.5	60.0	-	-	150	250	250	500	500	1000	400	600	-	-
63	71.2	91.4	66.2	75.6	-	-	189	315	315	630	630	1260	504	756	-	-

Characteristic

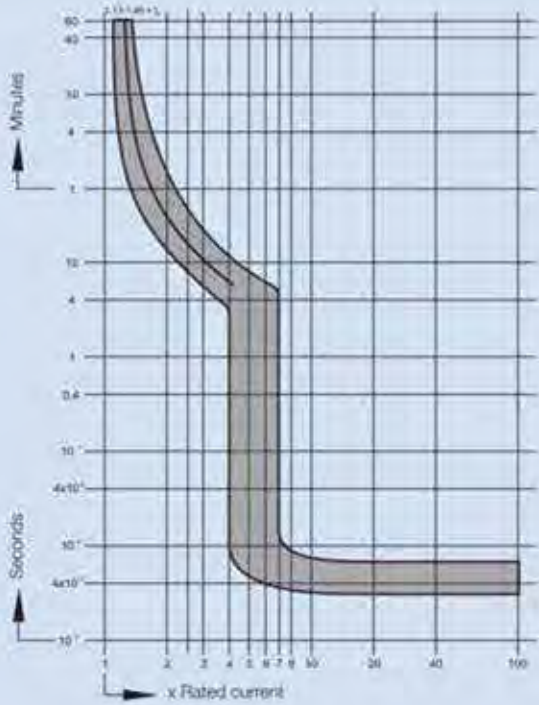

B characteristic $I_n = 0.3 - 8 \text{ A}$

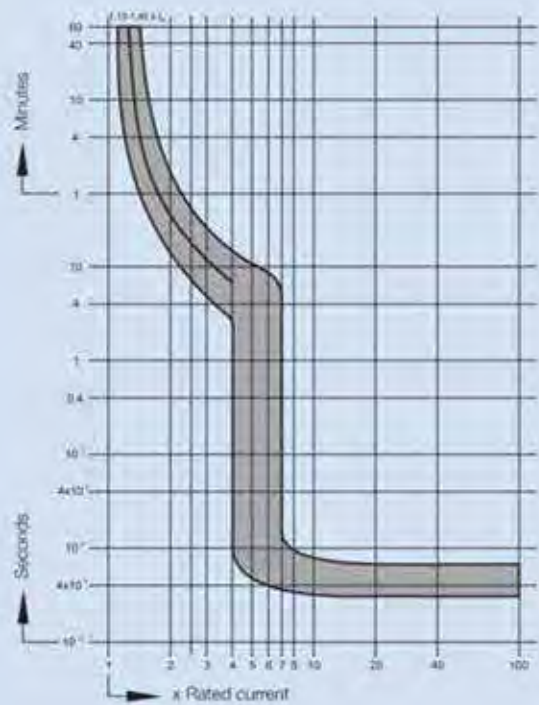

B characteristic $I_n = 10 - 40 \text{ A}$

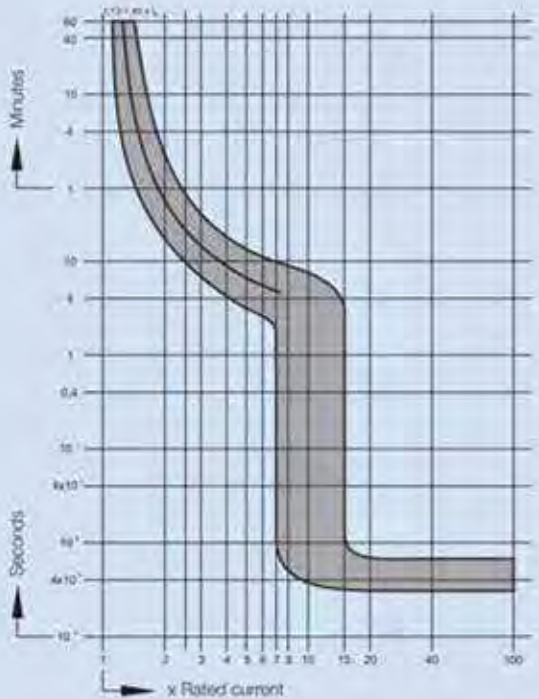

C characteristic $I_n = 0.3 - 8 \text{ A}$

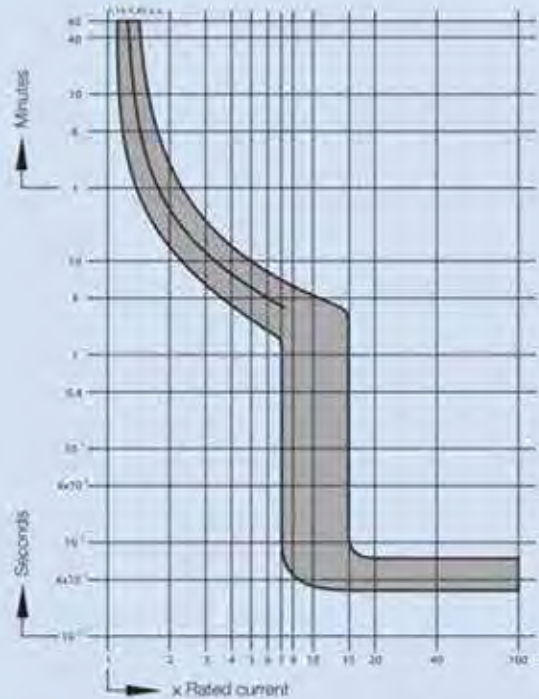

C characteristic $I_n = 10 - 40 \text{ A}$

Busbars for S, SL and T miniature circuit breakers, MA motor circuit breakers and residual current circuit breakers

Cross section (mm ²)	Busbar current Start of busbar/ Middle infeed	Modules/ Phases	Article no.	Weight g/each	Packing unit	Suitable end cap Article no.
----------------------------------	---	-----------------	-------------	---------------	--------------	------------------------------



Busbars fork type						
1-phase						
12	65/110	56	SB16010	250	50	
1-phase 1-pole circuit breaker + auxiliary contact						
24	90/150	37/1	SDO.124	200	50	
2-phase and 1-phase + N						
10	63/100	28/2	SB26010	390	20	SB.A5
2-phase 2-pole circuit breaker + auxiliary contact						
16	80/130	22/2	SB26216	310	20	SB.A2
3-phase						
10	63/100	4/3	SB31210	84	25	SB.A1
10	63/100	19/3	SB36010	420	20	SB.A1
16	80/130	19/3	SB36016	675	20	SB.A2
3-phase 3-pole circuit breaker + auxiliary contact						
16	80/130	16/3	SB36316	630	20	SB.A2
3-phase 1-pole circuit breaker + auxiliary contact						
16	80/130	36/1	SDO.316	500	20	SB.A2
4-phase and 3-phase + N						
16	80/130	14/4	SB46016	835	15	SB.A3



End caps for busbars				
for busbars article no.	Article no.	Weight g/each	Packing unit	
SB31210, SB36010	SB.A1	0,8	10	
SB36016, SB36316, SDO.316, SB718U, SB26216	SB.A2	1	10	
SB46016	SB.A3	1,1	10	
SB26010	SB.A5	0,8	10	



ABL SURSUM miniature circuit breakers according to UL 508 have been approved for the following applications:

- Group installations
- Motor starting across the line
- AC general applications (general use)
- AC ohmic loads (resistance)
- AC incandescent lamps (discharge lamps)
- AC fluorescent lamps (incandescent lamps)
- Switching under load for all load types

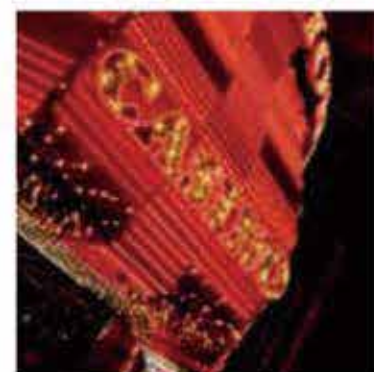

according to UL 508 and CSA-22.2 No.14

B, C und D also acc. to IEC 60898-1, DIN EN 60898-1, VDE 0641-11

This product range differentiates between:

- Standard products for normal market applications (shown in the table in bold – delivery time approx. 2 weeks)
- Exclusive products for sector-specific applications (shown in the table in normal print – longer delivery time)

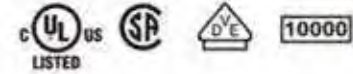

Rated current I_n A	Characteristic						Weight g/each	Packing unit
	B	C	D	G	E	Z		

3-pole								
0.3		3C03UM	3D03UM	3G03UM	3E03UM	3Z03UM	450	4
0.5		3C05UM	3D05UM	3G05UM	3E05UM	3Z05UM	450	4
0.75		3C075UM	3D075UM		3E075UM	3Z075UM	450	4
0.8				3G08UM				
1	3B1UM	3C1UM	3D1UM	3G1UM	3E1UM	3Z1UM	450	4
1.6	3B1.6UM	3C1.6UM	3D1.6UM	3G1.6UM	3E1.6UM	3Z1.6UM	450	4
2	3B2UM	3C2UM	3D2UM	3G2UM	3E2UM	3Z2UM	450	4
2.5	3B2.5UM	3C2.5UM	3D2.5UM	3G2.5UM	3E2.5UM	3Z2.5UM	450	4
3	3B3UM	3C3UM	3D3UM	3G3UM	3E3UM	3Z3UM	450	4
3.5	3B3.5UM	3C3.5UM	3D3.5UM	3G3.5UM	3E3.5UM	3Z3.5UM	450	4
4	3B4UM	3C4UM	3D4UM	3G4UM	3E4UM	3Z4UM	450	4
5	3B5UM	3C5UM	3D5UM	3G5UM	3E5UM	3Z5UM	450	4
6	3B6UM	3C6UM	3D6UM	3G6UM	3E6UM	3Z6UM	450	4
8		3C8UM	3D8UM	3G8UM	3E8UM	3Z8UM	450	4
10	3B10UM	3C10UM	3D10UM	3G10UM	3E10UM	3Z10UM	450	4
12				3G12UM		3Z12UM		
13	3B13UM	3C13UM	3D13UM	3G13UM	3E13UM	3Z13UM	450	4
15	3B15UM	3C15UM	3D15UM	3G15UM	3E15UM	3Z15UM		
16	3B16UM	3C16UM	3D16UM	3G16UM	3E16UM	3Z16UM	450	4
20	3B20UM	3C20UM	3D20UM	3G20UM	3E20UM	3Z20UM	450	4
25	3B25UM	3C25UM	3D25UM	3G25UM	3E25UM	3Z25UM	450	4
30	3B30UM	3C30UM	3D30UM	3G30UM	3E30UM	3Z30UM		
32	3B32UM	3C32UM	3D32UM	3G32UM	3E32UM	3Z32UM	450	4
40	3B40UM	3C40UM	3D40UM	3G40UM	3E40UM	3Z40UM	450	4
50	3B50UM	3C50UM	3D50UM	3G50UM	3E50UM	3Z50UM	450	4
60	3B60UM	3C60UM	3D60UM	3G60UM	3E60UM		450	4
63	3B63UM	3C63UM	3D63UM	3G63UM	3E63UM		450	4



Neutral switches

can be mounted on the right-hand side, suitable for all UL miniature circuit breakers and all current strengths

	Article no.	Weight g/each	Packing unit
1 M	N63UM	150	5



Applies to all circuit breakers...UM and N63UM and FA...UM:

Can either be connected by means of a busbars fork/ busbar or by a ring cable lug (screw can be released completely) using the upper mounting possibility (1). A box terminal (2) is available to use a stripped wire.



Applies to N63UM and FA...UM:

1. Bring the knobs of both devices into "OFF" position
2. Remove grey cover from the circuit breaker
3. Insert drive plate between the circuit breaker and N63UM
4. Combine circuit breaker and N63UM
5. Screw the two devices together

for S, SL and T miniature circuit breakers,
MA motor circuit breakers and residual current circuit breakers,
 also useable for UI and CSA miniature circuit breakers

Cross section (mm ²)	Busbar current Start of busbar/ End of busbar/	Number of poles	Article no.	Weight g/each	Packing unit
----------------------------------	--	-----------------	-------------	---------------	--------------



Busbars fork type						
3-phase						
10	63	6	G31006	37	25	
10	63/100	9	G31009	80	25	
10	63/100	12	G31012	84	25	
16	80	6	G31606	52	20	
16	80/130	9	G31609	87	20	
16	80/130	12	G31612	119	20	



Busbars fork type						
3-phase for left-hand RCCB installation in the distribution board (N omitted)						
10	63	11	G31011S	82	25	
16	80	11	G31611S	117	20	
3-phase for right-hand RCCB installation in the distribution unit						
16	80	11	G31611	108	20	

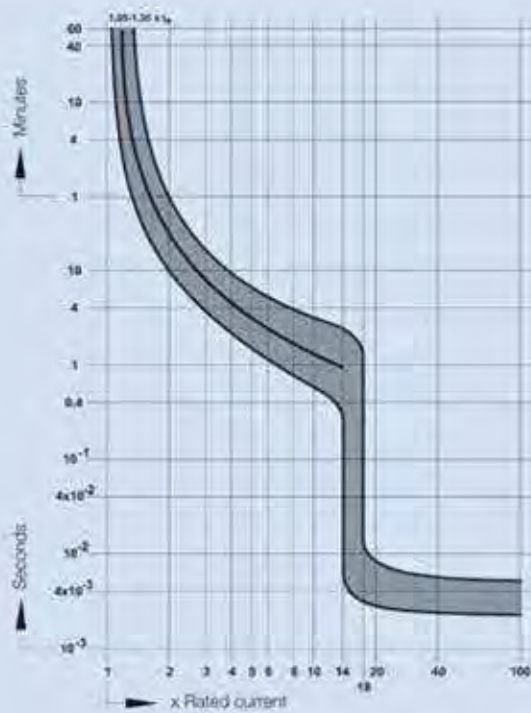

E characteristic $I_n = 0.3 - 10 \text{ A}$
UL

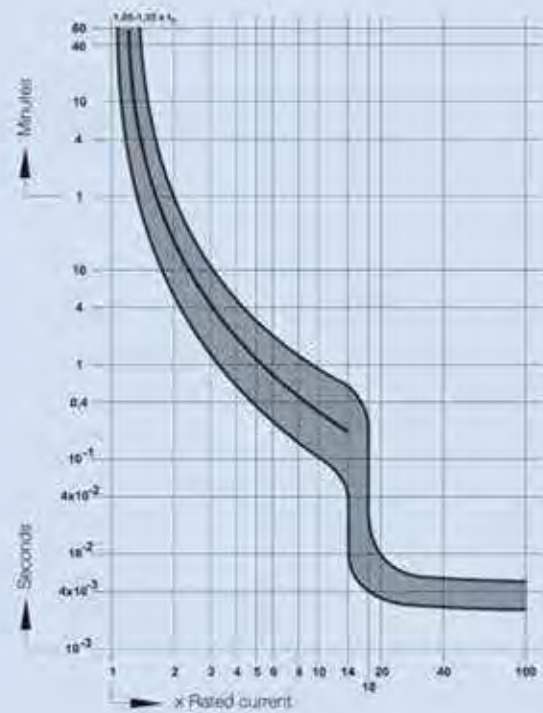

E characteristic $I_n = 12 - 50 \text{ A}$
UL

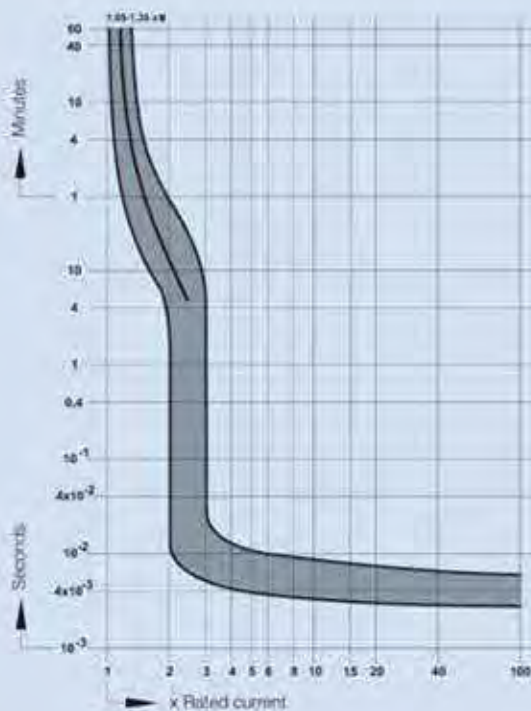

Z characteristic $I_n = 0.3 - 10 \text{ A}$
UL

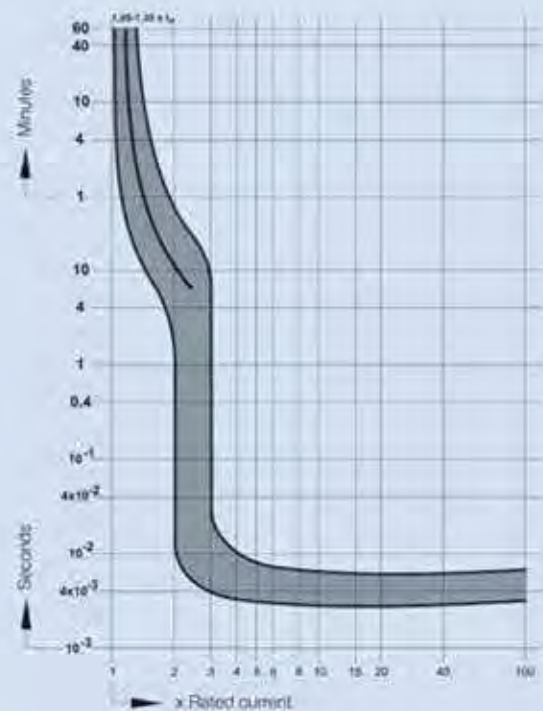

Z characteristic $I_n = 12.5 - 32 \text{ A}$
UL

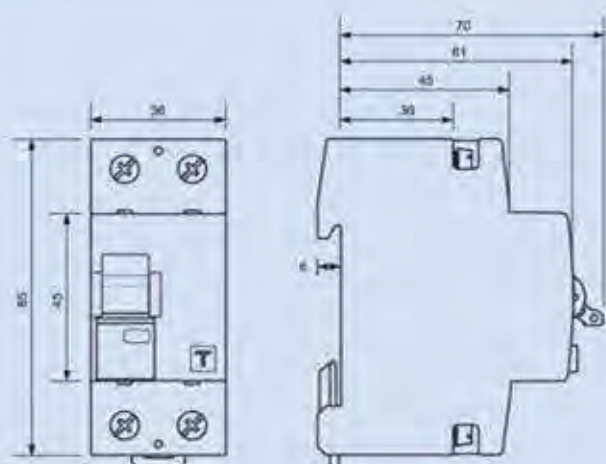

RP product range, 2-pole

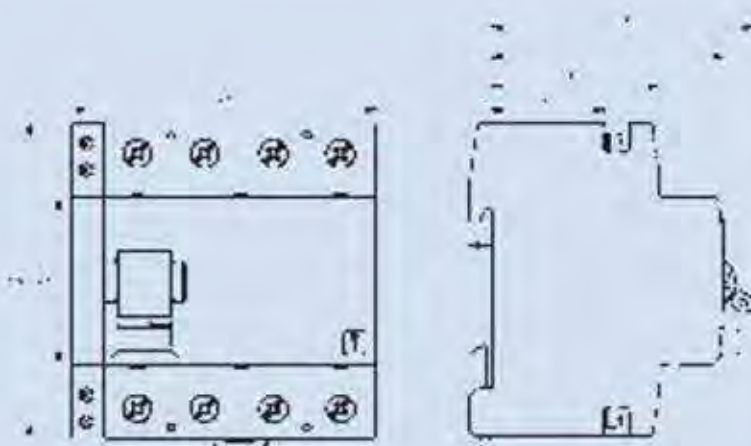

RP product range 4-pole

Function

RCCB independent of the mains voltage for realising the protective measure "protection through automatic power-supply cut-off", in compliance with the requirements of VDE 0100 part 410 and corresponding international construction regulations,

Characteristics

- 2-pole or 4-pole
- Large range of products with
 - Rated currents from 16 A to 125 A
 - Rated residual currents 0.03 A to 0.5 A
- Tripping independent of supply and auxiliary voltage
- Sensitive to AC and pulsating DC residual currents (type A)
- High short-circuit strength
- Double-sided two-tier terminals for large conductor cross-section and busbar
- Switch-position display
- Viewing window for labels
- Multi-functional switching knob with three functions:
 - **On** (top position)
 - **Off** (bottom position)
 - Display **"tripped"** (centre position)
 If the RCCB trips due to a fault, the switching knob stays in the centre position.

Type of mounting

- Quick mounting on DIN-rail according to EN 50022 in any standard distribution
- Any mounting position



RP product range, 2-pole



RP product range, 4-pole
25-80 A

Function

RCCBs independent of the mains voltage for realising the protective measure "protection through automatic power-supply cut-off", in compliance with the requirements of VDE 0100 part 410 or corresponding international construction regulations.

Due to a response delay, RCCBs of the RP4xxxK range react to pulse-shaped, short-time residual currents much less sensitively than undelayed RCCBs.

These RCCBs thus allow for fault-free operation even of those systems in which surge residual currents are created by switching actions or lightning effects.

The tripping times for undelayed RCCBs specified in the national and international building regulations are also met by the devices of this range. They can therefore generally be used instead of a standard switch.

Characteristics

- 4-pole
- Large range of products with
 - Rated currents from 16 A to 125 A
 - Rated residual currents 0.03 A to 0.5 A
- Tripping independent of supply and auxiliary voltage
- Sensitive to AC and pulsating DC residual currents (type A)
- Sensitive to AC residual currents (type AC)
- High short-circuit strength
- Double-sided two-tier terminals for large conductor cross-section and busbar
- Switch-position display
- Viewing window for labels
- Multi-functional switching knob with three functions:
 - **On** (top position)
 - **Off** (bottom position)
 - Display "**tripped**" (centre position)
 If the RCCB trips due to a fault, the switching knob stays in the centre position.

Type of mounting

- Quick mounting on DIN-rail according to EN 50022 in any standard distribution
- Any mounting position

Areas of application

Power supplies of residential and single-purpose buildings as well as industrial facilities with TN-S and TN-C-S networks, where normal RCCBs unwantedly trip as a result of transient drainage currents, such as

- Systems with long cable lengths behind the RCCB
- Lighting systems with many fluorescent lamps (> 20 pieces)
- Computer systems
- Solaria
- X-ray systems

The use in TN-C networks and in systems in which electronic equipment might cause smooth DC residual currents or residual currents with frequencies of $\neq 50$ Hz is excluded.

Accessories

- RH11 auxiliary contact
- Label sheet
- Free pictoplan labelling software (see page 25)

Seit

This product range differentiates between:

- Standard products for normal market applications (**shown in the table in bold – delivery time approx. 2 weeks**)
- Exclusive products for sector-specific applications (shown in the table in normal print – longer delivery time)

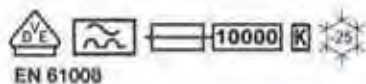

Rated resid. current $I_{\Delta n}$ mA	Rated current I_n A	Surge current strength -> A	Max. back-up fuse A	Modules	Article no.	Weight g/each	Packing unit
--	-----------------------------	--------------------------------	------------------------	---------	-------------	------------------	-----------------



4-pole, short-time delayed switch-off							
30	40	3,000	80	4	RP4303K	430	1
30	63	3,000	100	4	RP4403K	430	1

Type of mounting

- Quick mounting on DIN rail in accordance with EN 50022 in any standard distribution
- Any mounting position
- Infeed direction from above (N, 1, 3, 5)

Areas of application

Commercial or industrial installations where power electronics equipment is used or can be connected, such as:

- Frequency converters
- UPS systems
- Switched-mode power supplies
- High-frequency converters
- On-site power supply distribution boards
- Photovoltaic systems

Accessories

- RH11 auxiliary contact
- Label sheet
- Free pictoplan labelling software (see page 25)

Seit

Notes

- Not intended for use in DC power supplies
- In most cases, selective RCCBs protect the cable up to its sub-distribution
- To ensure the selectivity of the RCCB, the rated residual current of the RA4xxxS must be selected at least one level higher than that of the undelayed switch connected downstream.

This product range differentiates between:

- Standard products for normal market applications (**shown in the table in bold – delivery time approx. 2 weeks**)
- Exclusive products for sector-specific applications (shown in the table in normal print – longer delivery time)



Rated resid. current $I_{\Delta n}$ mA	Rated current I_n A	Surge current strength > A	Max. back-up fuse A	Modules	Article no.	Weight g/each	Packing unit
--	-----------------------------	-------------------------------	------------------------	---------	-------------	------------------	--------------



4-pole, selective switch-off							
300	40	5,000	80	4	RA4330S	450	1
300	63	5,000	100	4	RA4430S	500	1
300	80	5,000	125	4	RA4530S	500	1
300	100	5,000	125	4	RA4630S	500	1
300	125	5,000	125	4	RA4730S	500	1

Approved
as an export
version only!

RCCB – sensitive to alternating current Type AC

Short-time delayed switch-off
Export version – not approved in Germany

Function

RCCB independent of the supply voltage for realising the protective measure "protection through automatic power supply cutoff", in compliance with the requirements of international construction regulations.

Due to a response delay, RCCBs of the DFS 4 A KV and DFS 4 AC KV series will respond to impulse-type, short-time fault currents much less sensitively than undelayed RCCBs. These RCCBs thus allow for fault-free operation even of those systems in which surge residual currents are created by switching actions or lightning effects.

The tripping times for undelayed RCCBs specified in the national and international building regulations are also met by the devices of the DFS 4 A KV and DFS 4 AC KV series. They can therefore generally be used instead of a standard switch.

Characteristics

- 4-pole
- Low sensitivity for surge residual currents
- Large range of products with
 - Rated currents from 16 A to 125 A
 - Rated residual currents 0.03 A to 0.5 A
- Tripping independent of supply and auxiliary voltage
- Sensitive to AC and pulsating DC residual currents (type A)
- Sensitive to AC residual currents (type AC)
- High short-circuit strength
- Double-sided two-tier terminals for large conductor cross-section and busbar
- Switch-position display
- Viewing window for labels
- Multi-functional switching knob with three functions:
 - **On** (top position)
 - **Off** (bottom position)
 - Display "**tripped**" (centre position)

If the RCCB trips due to a fault, the switching knob stays in the centre position

Type of mounting

- Quick mounting on DIN rail in accordance with EN 50022 in any standard distribution
- Any mounting position

Areas of application

Power supplies of residential and single-purpose buildings as well as industrial facilities with TN-S and TN-C-S networks, where normal RCCBs have undesired trippings as a result of transient drainage currents, such as

- Systems with large cable lengths behind the RCCB
- Lighting installations with many fluorescent lamps (>20 pieces)
- Computer systems
- Solaria
- X-ray systems

The use in TN-C networks and in systems in which electronic equipment might cause smooth DC residual currents or residual currents with frequencies of $\neq 50$ Hz is excluded.

Accessories

- RH11 auxiliary contact
- Label sheet
- Free pictoplan labelling software (see page 25)

Seite

Exclusive products for sector-specific uses – please note longer delivery periods!

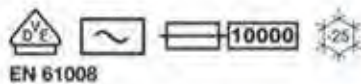

EN 61008

Rated resid. current $I_{\Delta n}$ mA	Rated current I_n A	Surge current strength - A	Max. back-up fuse A	Modules	Article no.	Weight g/each	Packing unit
--	-----------------------------	-------------------------------	------------------------	---------	-------------	---------------	--------------

4-pole, short-time delayed switch-off							
30	40	3,000	80	4	RW4303K	450	1
30	63	3,000	100	4	RW4403K	450	1



General explanations

Additional protection in case of direct contact according to VDE 0100-410 (operator protection)

By using high-sensitivity RCDs with a rated residual current of $I_{\Delta n} \leq 30$ mA, additional protection in case of direct contact with an (unearthed) part conducting voltage is achieved (see Figure 2).

This additional protection is necessary if

- The insulation of totally-insulated devices or a feed cable is damaged,
- The protective conductor is interrupted,
- The protective and active conductor got mixed up and conductive parts which are normally earthed are thus energised, or
- There is contact with a part which is energised under normal operating conditions during repair work.

Based on this extended protection scope, the VDE set of standard specifications stipulates the use of a residual current circuit breaker according to VDE 0664-10 or an RCBO according to VDE 0664-20 with $I_{\Delta n} \leq 30$ mA for the construction of systems in areas that are particularly accident-prone.

This applies to, for example,

- Outlet circuits in rooms with a bath tub or a shower (VDE 0100-701)
- Caravans, boats and yachts as well as their power supplies
- Camping sites or moorings (VDE 0100-721)
- Rooms used for medical purposes (VDE 0107).

By no means must this additional protection be considered a basic protection measure since the residual current flows through the human body into the earth in case of direct contact. It is rather an "emergency brake" for the fault events mentioned above. According to VDE 0100-530, only RCDs in compliance with section 1.5 may be used for additional protection.

Fire protection

Effective protection against fires caused by earth faults can even be achieved with relatively insensitive RCDs ($I_{\Delta n} \leq 300$ mA). For earth residual currents ≤ 300 mA, the electric power transferred at the fault location is normally not sufficient to ignite standard flammable materials.

Although ignition is possible for higher residual currents because of the power, the RCD switches off the power supply in less than 0.3 seconds and thus limits the electric ignition power to harmless values.

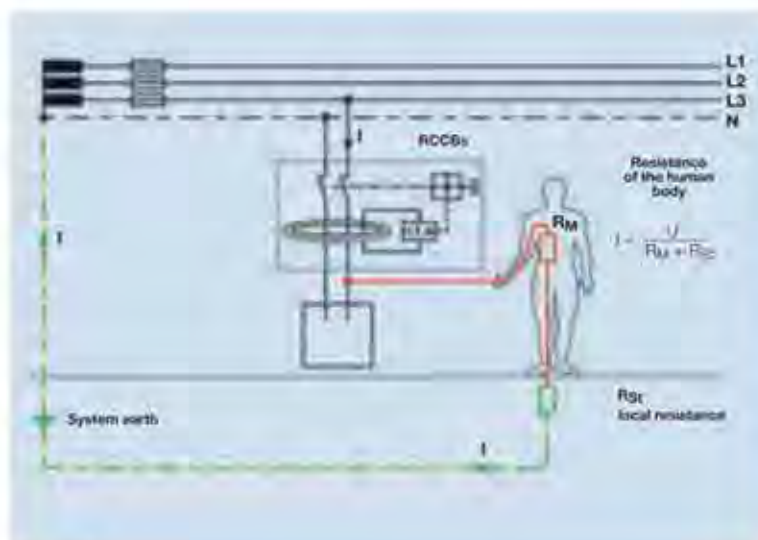
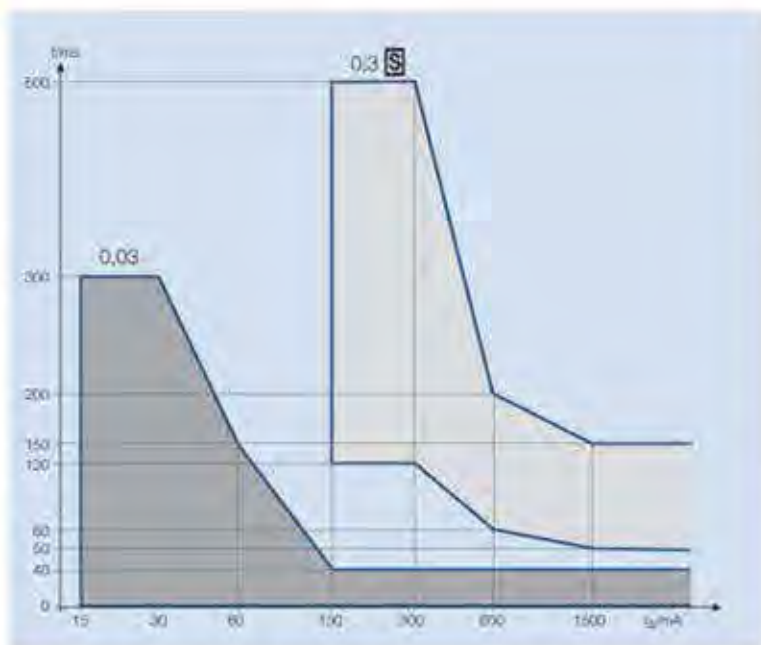

Figure 2

RCDs for fault protection, operator protection and fire protection

According to VDE 0100-530 (construction of non-voltage systems - part 530: selecting and setting up electrical equipment, switchgears and control gears), the following RCDs can be used for the protection targets mentioned above:

- Residual current circuit breakers according to DIN EN 61008-1 VDE 0664-10
Abbreviation: **RCCB**
(Residual Current operated Circuit Breaker without integral overcurrent protection)
- RCBOs according to DIN EN 61009-1 VDE 0664-20
Abbreviation: **RCBO**
(Residual Current operated Circuit Breaker with integral Overcurrent Protection)
- Circuit breakers with residual current trip according to DIN EN 60947-2 VDE 660-101 Appendix B
Abbreviation: **CBR**
(Circuit Breaker providing Residual current protection)
- Modular Residual Current Protective Devices (abbreviation: **MRCD**) according to DIN EN 60947-2 VDE 0660-101 Appendix M whose units for measuring differential current (transformers), assessing differential current (differential current relays) and the load switch unit are accommodated in separated enclosures can be used in systems that are operated and, on a regular basis, maintained by people with electrotechnical expertise.
In systems where it is not possible to install the devices mentioned above – e.g. because an instant switch-off means endangering people or creating a lot of material damage – **RCM** differential current monitoring devices (abbreviation for Residual Current Monitor) according to DIN EN 62020 VDE 0662 can be used.



Switch-off times of an RCCB responding in an undelayed and in a delayed (selective) manner

Selectivity

Selective RCDs only react to the occurrence of residual current after a current flow duration of several supply-frequency periods. This makes selective switch-off possible if, for example, two RCD residual current circuit breakers are connected in series, i.e. even for high residual currents, only that RCD in whose downstream system part the earth fault occurs reacts in the event of fault.

The figure below makes this correlation clear.

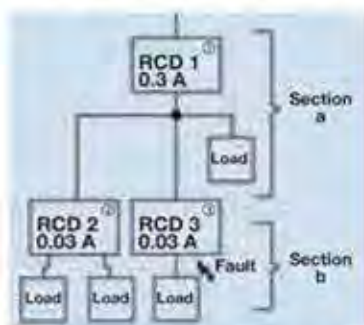

Selective switch-off if two RCDs for sequenced residual current protection are connected in series

If an undelayed RCD was used instead of an RCD 1, every residual current $I_{\Delta} > 0.3 \text{ A}$ in system part b would trip both RCD 1 and RCD 3.

Only the response delay of the selective RCD 1 ensures that only RCD 3 responds.

The response time of both selective and normal RCDs can depend on the amount and type of the residual current.

The above figure (Switch-off times) gives an example of a normal residual current circuit breaker with $I_{\Delta n} = 30 \text{ mA}$ and a selective circuit breaker with $I_{\Delta n} = 300 \text{ mA}$ to illustrate this.

The rated residual current of the delayed RCD must, compared to the undelayed RCD, be chosen at least one level higher to ensure selectivity in any case (i.e. also for small residual currents). In a system with selective sequences, the earth resistance R_A must not be any greater than half the value to be found in table 1.

In the event of fault, this enables a residual current with twice the value of the rated residual current to flow without the permitted touch voltage $U_{t,zul}$ being exceeded so that also the delayed RCCB is activated within a period of $< 300 \text{ ms}$.

Selective RCCBs have a surge current strength of $> 5 \text{ kA}$.

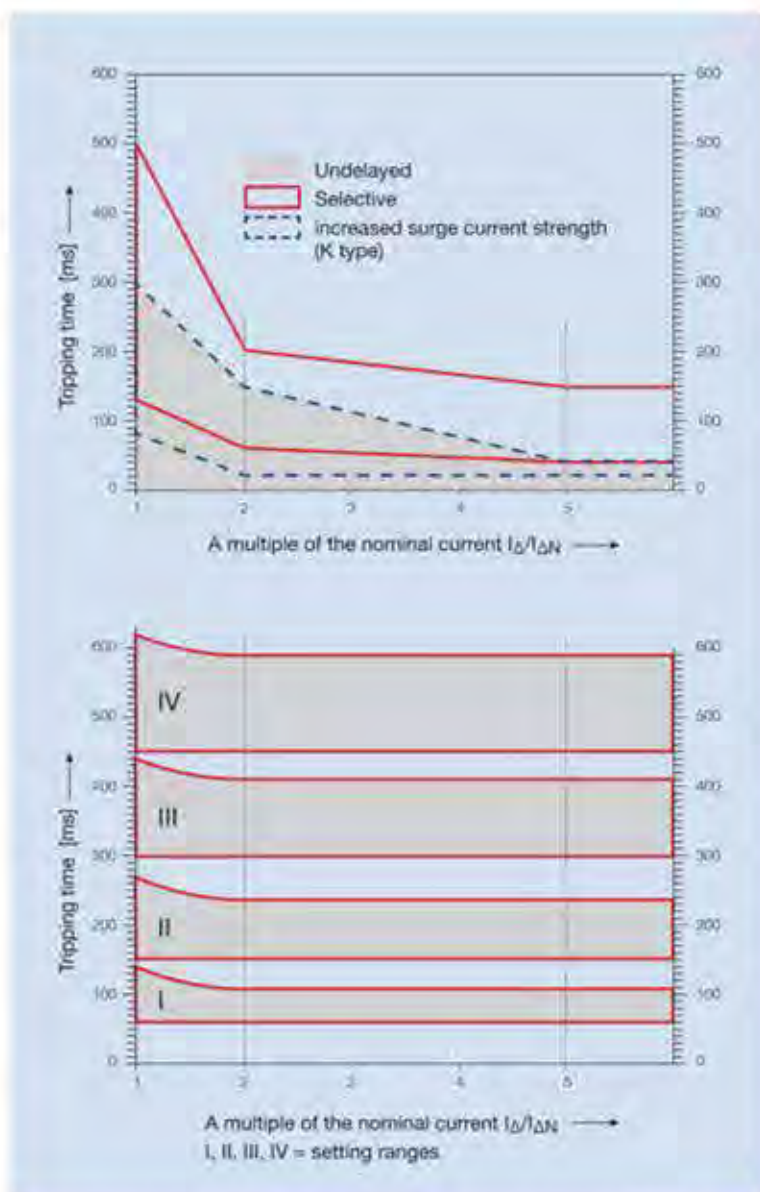

Total switch-off times for undelayed and delayed RCCBs

RA (sensitive to universal current), 4 pole
short-time delayed, selective

Technical data						
Characteristic	Type B (sensitive to universal current)					
No. of poles	4					
Rated current I_n	25 A	40 A	63 A	80 A	100 A	125 A
Rated residual current $I_{\Delta n}$	0.03 A / 0.3 A / 0.5 A					
Tripping frequency range	Short-time delayed: 0 – 1 MHz / selective: 0 – 100 kHz					
Surge current strength	Short-time delayed: 3 kA / selective: 5 kA lightning impulse current 8/20 μ s					
Rated voltage U_n	230 V AC / 400 V AC					
Minimum operating voltage necessary for detecting residual currents of type A for detecting residual currents of type B	0 V (independent of mains voltage) ²⁾ 30 V AC					
Max. permissible operational voltage	$U_n + 10\%$					
Rated frequency	50 Hz					
Voltage operating area of the test equipment	185 V AC – 440 V AC					
Maximum switch-off times	$1 \times I_{\Delta n} : \leq 300 \text{ ms} / 5 \times I_{\Delta n} : \leq 40 \text{ ms}$					
Response delay	$1 \times I_{\Delta n} : 130 \text{ ms} < T \leq 500 \text{ ms} / 5 \times I_{\Delta n} : 50 \text{ ms} < T \leq 150 \text{ ms}$					
Rated switching capacity I_m	500 A	500 A	800 A	800 A	1000 A	1250 A
Rated fault switching capacity $I_{\Delta m}$	500 A	500 A	800 A	800 A	1000 A	1250 A
Conditional rated short-circuit current I_c	10 kA					
Conditional rated fault short-circuit current $I_{\Delta c}$	10 kA					
Short-circuit back-up fuse DIN VDE 0636 / IEC 60269-1	see table on page 97			Seite		
Power loss	1.5 W	4.0 W	8.5 W	14 W	22 W	30 W
Intrinsic consumption	max. 3.5 W					
Infeed side (res. current to 80 A)	Terminals 1, 3, 5, N ¹⁾					
Infeed side (res. current 100/125 A)	Terminals N, 3, 5, 7 ¹⁾					
Operating position	Any					
Degree of protection	IP 40 (acc. to distribution board install.)					
Resistance to mechanical shocks	20 g / 20 ms duration					
Vibration resistance	> 5g ($f \leq 80 \text{ Hz}$, duration > 30 min)					
Ambient temperature range	- 25 °C to + 40 °C					
Resistance to climate	Acc. to DIN IEC 60068-2-30: Moist heat / cyclical (25 °C / 55 °C : 93 % / 97 % rH)					
Cross sections of connection lines						
Circular conductor, solid	1 x 1.5 – 50 mm ² (1-conductor connection) / 2 x 1.5 – 16 mm ² (2-conductor connection)					
Multiple wire	1 x 1.6 – 50 mm ² (1-conductor connection) / 2 x 1.6 – 16 mm ² (2-conductor connection)					
Fine wire	1 x 1.5 – 35 mm ² (1-conductor connection) / 2 x 1.5 – 16 mm ² (2-conductor connection)					
Terminal screw torque	3 Nm					
Minimum conductor cross section	50 mm ²					
Mechanical service life	> 5,000 switching cycles					
Electrical service life	> 2,000 switching cycles					
Building regulations	Standards??? DIN VDE 0664 T 10, E DIN VDE 0664 T 100					
Electromagnetic compatibility	DIN VDE 0664 T 30, DIN VDE 0839 T 6 – 2 (interference resistance – industrial applications)					

¹⁾ Recommended for simple insulation tests on the system side, because in this way the internal overvoltage-protection elements can be disconnected from the load side of the system by switching off the B-type RCCB.

²⁾ For supply voltages below 30 V AC, tripping caused by A and AC-type residual currents is guaranteed due to a function independent of mains voltage.

Short circuit selectivity to fuses in kA													
RCBO 6 kA													
		Rated current I_n (A)											
Characteristic	B	6	10	13	16	20	25	32	40				
	C	6	10	13	16	20	25	32	40				
I_n (A)													
Fuse according to DIN VDE 0636 operating class	16	0.4											1.)
		0.35											
	20	0.7	0.5	0.45	0.45								
		0.55	0.45	0.4	0.4								
	25	1.1	0.75	0.7	0.7	0.7							
		0.8	0.7	0.6	0.6	0.6							
	35	2.0	1.4	1.3	1.3	1.3	1.3						
		1.5	1.4	1.2	1.2	1.2	1.2	1.2					
	50	4.1	2.4	2.0	2.0	2.0	2.0	2.0	2.0	2.0	2.0	1.8	1.8
	2.8	2.3	2.0	2.0	2.0	2.0	2.0	2.0	2.0	2.0	2.0	1.8	
63	6.0	3.4	2.7	2.7	2.7	2.7	2.7	2.7	2.7	2.7	2.7	2.7	
	4.7	3.3	3.0	3.0	3.0	3.0	3.0	3.0	3.0	2.8	2.8	2.8	
80	6.0	4.2	3.6	3.6	3.6	3.6	3.6	3.6	3.6	3.6	3.6	3.6	
	6.0	4.2	3.5	3.5	3.5	3.5	3.5	3.5	3.5	3.5	3.5	3.5	
100	6.0	6.0	6.0	6.0	6.0	6.0	6.0	6.0	6.0	6.0	6.0	6.0	
	6.0	6.0	6.0	6.0	6.0	6.0	6.0	6.0	6.0	6.0	6.0	6.0	

1.) There is no more overload selectivity above the step line.

Short circuit selectivity to fuses in kA					
RCBO 10 kA					
		Rated current I_n (A)			
Characteristic	B	10	13	16	
	C	10	13	16	16
I_n (A)					
Fuse according to DIN VDE 0636 operating class	16				1.)
	20	0.55	0.5	0.5	
		0.5	0.5	0.5	0.5
	25	0.8	0.75	0.75	
		0.8	0.7	0.7	0.7
	35	1.5	1.4	1.4	
		1.5	1.3	1.3	1.3
	50	2.8	2.3	2.3	2.3
	2.7	2.3	2.3	2.3	
63	4.6	3.9	3.9	3.9	
	5.0	4.0	4.0	4.0	
80	7.0	6.0	6.0	6.0	
	7.0	5.0	5.0	5.0	
100	10.0	10.0	10.0	10.0	
	10.0	10.0	10.0	10.0	

1.) There is no more-overload selectivity above the step line