

Monitoring Relays

True RMS 3-Phase, 3-Phase+N, Multifunction

Types DPC01, PPC01

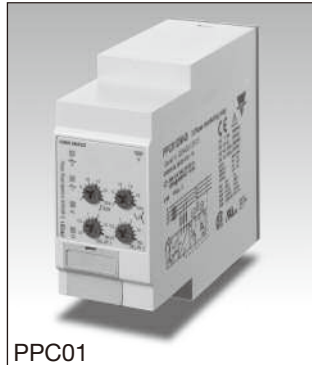
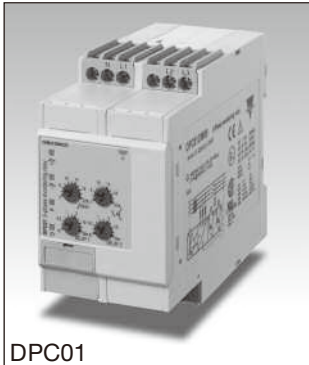

- TRMS 3-phase over and under voltage, phase sequence, phase loss, asymmetry and tolerance monitoring relay
- Detect when all 3 phases are present and have the correct sequence
- Detect if all the 3-phase-phase or phase-neutral voltages are within the set limits
- Detect if asymmetry and tolerance are within the set value
- Separately adjustable setpoints
- Separately adjustable delay functions (0.1 to 30 s)
- Output: 2 x 8 A relay SPDT NE
- For mounting on DIN-rail in accordance with DIN/EN 50 022 (DPC01) or plug-in module (PPC01)
- 45 mm Euronorm housing (DPC01) or 36 mm plug-in module (PPC01)
- LED indication for relays, alarm and power supply ON

Product Description

3-phase or 3-phase+neutral line voltage monitoring relay for phase sequence, phase loss, asymmetry, tolerance, over and under voltage (separately adjustable set points)

with built-in time delay function. Supply ranges from 100 to 690 VAC covered by three multivoltage relays.

Ordering key

DPC 01 D M48



Type Selection

Mounting	Output	Frequency	Supply: 100 to 115 VAC	Supply: 208 to 240 VAC	Supply: 380 to 415 VAC
DIN-rail	2 x SPDT	50 - 60 Hz	DPC 01 D M11 400HZ	DPC 01 D M23	DPC 01 D M48 400HZ PPC 01 D M48
DIN-rail	2 x SPDT	50 - 400 Hz		DPC 01 D M23 400HZ	
Plug-in	2 x SPDT	50 - 60 Hz		PPC 01 D M23	
Mounting	Output	Frequency	Supply: 440 to 480 VAC	Supply: 380 to 480 VAC	Supply: 600 to 690 VAC
DIN-rail	2 x SPDT	50 - 60 Hz	DPC 01 D M49 400HZ	DPC 01 D M48	DPC 01 D M69 DPC 01 D M69 400HZ
DIN-rail	2 x SPDT	50 - 400 Hz			

Input Specifications

Input	DPC01: PPC01:	Terminals	Ranges	
L1, L2, L3, N		L1, L2, L3, N 5, 6, 7, 11	Upper level Lower level Asymmetry Tolerance	+2 to +22% of the nominal voltage -22 to -2% of the nominal voltage 2 to 22% of the nominal voltage 2 to 22% of the nominal voltage
Note: Connect the neutral only if it is intrinsically at the star centre			Note: The input voltage must not exceed the maximum rated voltage or drop below the minimum rated voltage reported above.	
Measuring ranges			Hysteresis	
M11		85 to 132 ΔVAC	Set points from 2 to 5%	1%
M23		177 to 275 ΔVAC	Set points from 5 to 22%	2%
M48	DPC01	323 to 550 ΔVAC		
	DPC01 400HZ	323 to 475 ΔVAC		
	PPC01	323 to 475 ΔVAC		
M49	DPC01	375 to 550 ΔVAC		
M69	DPC01	510 to 793 ΔVAC		

Output Specifications

Output Rated insulation voltage	2 x SPDT relays N.E. 250 VAC
Contact ratings (AgSnO₂) Resistive loads AC 1 DC 12 Small inductive loads AC 15 DC 13	μ 8 A @ 250 VAC 5 A @ 24 VDC 2.5 A @ 250 VAC 2.5 A @ 24 VDC
Mechanical life	≥ 30 x 10 ⁶ operations
Electrical life	≥ 10 ⁵ operations (at 8 A, 250 V, cos φ = 1)
Operating frequency	≤ 7200 operations/h
Dielectric strength Dielectric voltage Rated impulse withstand volt.	≥ 2 kVAC (rms) 4 kV (1.2/50 μs)

Supply Specifications

Power supply Rated operational voltage through terminals: L1, L2, L3, N (DPC01) 5, 6, 7, 11 (PPC01) M11 - Delta Voltage: M23 - Delta Voltage: DPC01 M48 - Delta Voltage: DPC01 M48 - Star Voltage: PPC01 M48 - Delta Voltage: PPC01 M48 - Star Voltage: M48 400HZ - Delta Voltage: M48 400 HZ- Star Voltage: M49 400HZ - Delta Voltage: M49 400 HZ- Star Voltage: M69 - Delta Voltage: M69 - Star Voltage: M69 400HZ- Delta Voltage: M69 400HZ- Star Voltage:	Overvoltage cat. III (IEC 60664, IEC 60038) 100 to 115VAC ±15%; 45 to 65Hz 208 to 240VAC ±15%; 45 to 65Hz 380 to 480VAC ±15%; 45 to 65Hz 220 to 277VAC ±15%; 45 to 65Hz 380 to 415VAC ±15%; 45 to 65Hz 220 to 240VAC ±15%; 45 to 65Hz 380 to 415VAC ±15%; 45 to 440Hz 220 to 240VAC ±15%; 45 to 440Hz 440 to 480VAC ±15%; 45 to 440Hz 254 to 277VAC ±15%; 45 to 440Hz 600 to 690VAC ±15%; 45 to 65Hz 347 to 400VAC ±15%; 45 to 65Hz 600 to 690VAC ±15%; 45 to 440Hz 347 to 400VAC ±15%; 45 to 440Hz
Rated operational power M11 M23 M48 M69	8 VA @ Δ115 VAC, 50 Hz 9 VA @ Δ230 VAC, 50 Hz 13 VA @ Δ400 VAC, 50 Hz 21 VA @ Δ600 VAC, 50 Hz Supplied by L2 and L3 for the DIN-rail versions and by L1 and L2 for the Plug-in versions

General Specifications

Power ON delay	1 s ± 0.5 s or 6 s ± 0.5 s	Housing	
Accuracy Temperature drift Delay ON alarm Repeatability	(15 min warm-up time) ± 1000 ppm/°C ± 10% on set value ± 50 ms ± 0.5% on full-scale	Dimensions	DPC01 45 x 80 x 99.5 mm PPC01 36 x 80 x 94 mm
Reaction time Incorrect phase sequence or total phase loss Voltage level Asymmetry level Alarm ON delay: Alarm OFF delay:	< 200 ms (input signal variation from -20% to +20% or from +20% to -20% of set value) < 200 ms (delay < 0.1 s) < 200 ms (delay < 0.1 s)	Weight	Approx. 220 g
Indication for Power supply ON Alarm ON Output relays ON	LED, green LED, red (flashing 2 Hz during delay time) 2 x LED, yellow	Screw terminals Tightening torque	(DPC01) Max. 0.5 Nm acc. to IEC 60947
Environment Degree of protection Pollution degree Operating temperature @ Max. voltage, 50 Hz @ Max. voltage, 60 Hz Storage temperature	(EN 60529) IP 20 3 (DPC01), 2 (PPC01) -20 to +60°C, R.H. < 95% -20 to +50°C, R.H. < 95% -30 to +80°C, R.H. < 95%	Approvals	UL, CSA GL (DPC01 only, except 400Hz, M11)
		CE Marking	Yes
		EMC Immunity Emissions	Electromagnetic Compatibility According to EN 61000-6-2 According to EN 61000-6-3

Mode of Operation

Asymmetry definition.

Asymmetry is an indicator of the mains quality and it is defined as the absolute value of the maximum deviation among the mains voltages, divided by the nominal voltage of the 3-phase system. The definition changes according to the voltage reference:

- 1) in case of measuring phase-phase voltages:

$$\frac{\max |\Delta V_{PH-PH}|}{V_{\Delta NOM}} \times 100$$

- 2) in case of measuring phase-neutral voltages:

$$\frac{\max |\Delta V_{PH-N}|}{V_{\Delta NOM}} \times 100$$

Tolerance definition.

Tolerance is another indicator of the mains quality and it is defined as the absolute value of the maximum deviation of the mains voltages from the nominal voltage, divided by the nominal voltage of the 3-phase system. The definition changes according to the voltage reference:

- 1) in case of measuring phase-phase voltages:

$$\frac{\max |V_{\Delta NOM} - V_{PH-PH}|}{V_{\Delta NOM}} \times 100$$

- 2) in case of measuring phase-neutral voltages:

$$\frac{\max |V_{\Delta NOM} - V_{PH-N}|}{V_{\Delta NOM}} \times 100$$

Connected to the 3 phases (and neutral) DPC01 and PPC01 operate when all 3 phases are present at the same time and the phase sequence is correct. It can be decided whether to monitor upper and lower voltage level of each phase or their asymmetry and tolerance.

Voltage level monitoring:

if one or more phase-phase or phase-neutral voltage exceed the upper set level or drop below the lower set level, the red LED starts flashing 2 Hz and the respective output relay releases after the set time period.

Asymmetry and tolerance monitoring:

if one or more phase-phase or phase-neutral voltage exceed the set levels the red LED starts flashing 2 Hz and the respective output relay releases after the set time period.

Note: For both functions, if the phase sequence is wrong or one phase is lost, both output relays release immediately. Only 200 ms delay occurs. The failure is indicated by the red LED flashing 5 Hz during the alarm condition.

Example 1

(Mains monitoring - over and under phase-phase voltage) The relay monitors over and under voltage, phase loss and correct phase sequence.

Example 2

(Motor monitoring - starting and operating load -asymmetry and tolerance of phase-neutral voltage) DPC01 and PPC01 ensure correct starting and operating conditions. They monitor the voltage level, phase sequence (correct direction of the motor rotation) and asymmetry.

Frequent failures are fuse blowing and incorrect voltage level. In case of fuse blowing the motor regenerates a voltage in the interrupted phase. The relay detects the failure and reacts due to excessive imbalance among the phases.

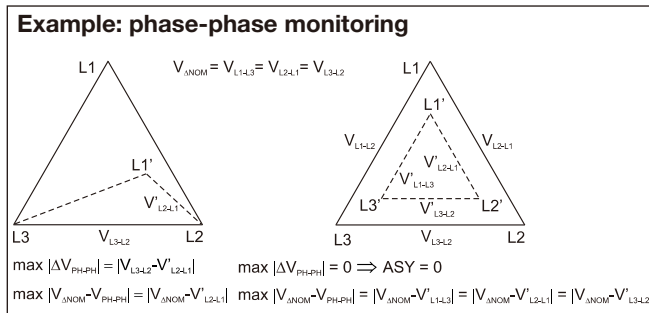
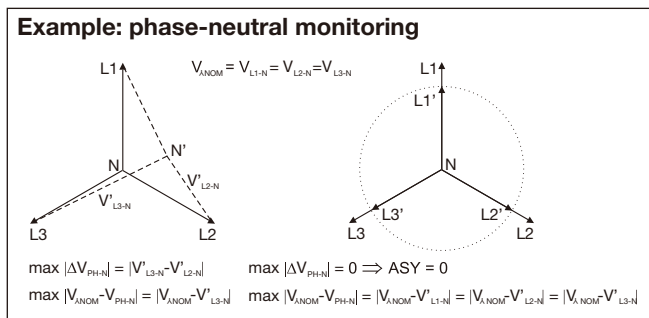

Function/Range/Level/Time Setting

Adjust the input range setting the DIP-switches 3 and 4. Select the desired function setting the DIP-switches 5 and 6 as shown below. To

access the DIP-switches open the plastic cover using a screwdriver as shown below.

Centre knobs:

Setting of upper (r) and lower (λ) level or setting of asymmetry (ASY) and tolerance (ζ) on relative scale.

Lower knobs:

Setting of delay on alarm times (DELAY 1, DELAY 2) on absolute scale: 0.1 to 30 s.

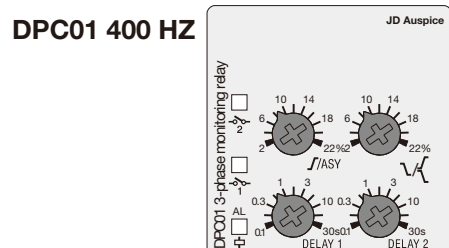
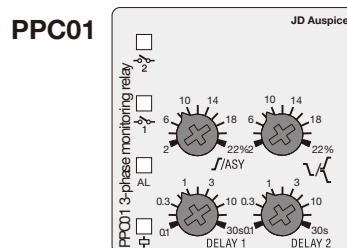
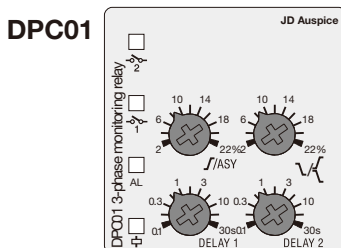

Function/Range/Level/Time Setting (cont.)

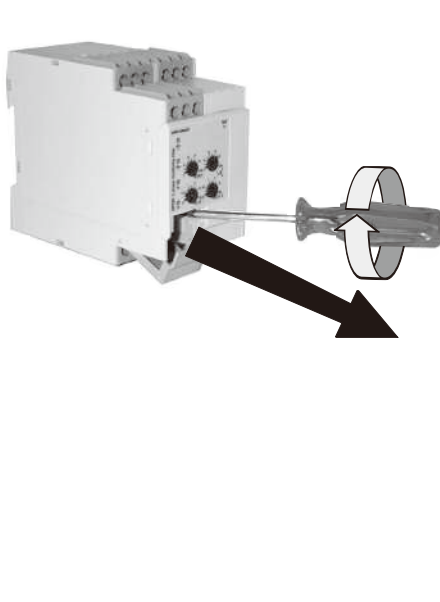

Power-ON delay
ON: 6 s ± 0.5 s
OFF: 1 s ± 0.5 s

Monitoring
ON: Phase-Neutral voltages
OFF: Phase-Phase voltages

Measuring range

SW3	ON	ON	OFF	OFF
SW4	ON	OFF	ON	OFF
M11 Ph-Ph Voltage	100 VAC	100 VAC	115 VAC	115 VAC
M23 Ph-Ph Voltage	208 VAC	220 VAC	230 VAC	240 VAC
M48 Ph-Ph Voltage	380 VAC	400 VAC	415 VAC	480 VAC DPC01 only
M48 Ph-N Voltage	220 VAC	230 VAC	240 VAC	277 VAC DPC01 only
M49 Ph-Ph Voltage	440 VAC	440 VAC	480 VAC	480 VAC
M49 Ph-N Voltage	254 VAC	254 VAC	277 VAC	277 VAC
DPC01DM69 Ph-Ph Volt.	600 VAC	600 VAC	690 VAC	690 VAC
DPC01DM69 Ph-N Volt.	347 VAC	347 VAC	400 VAC	400 VAC

Output
ON: 2 x SPDT relays
OFF: 1 x DPDT relay

Function
ON: Asymmetry and tolerance monitoring
OFF: Over and undervoltage monitoring

Operation Diagrams

Over and undervoltage monitoring (2 x SPDT relays)

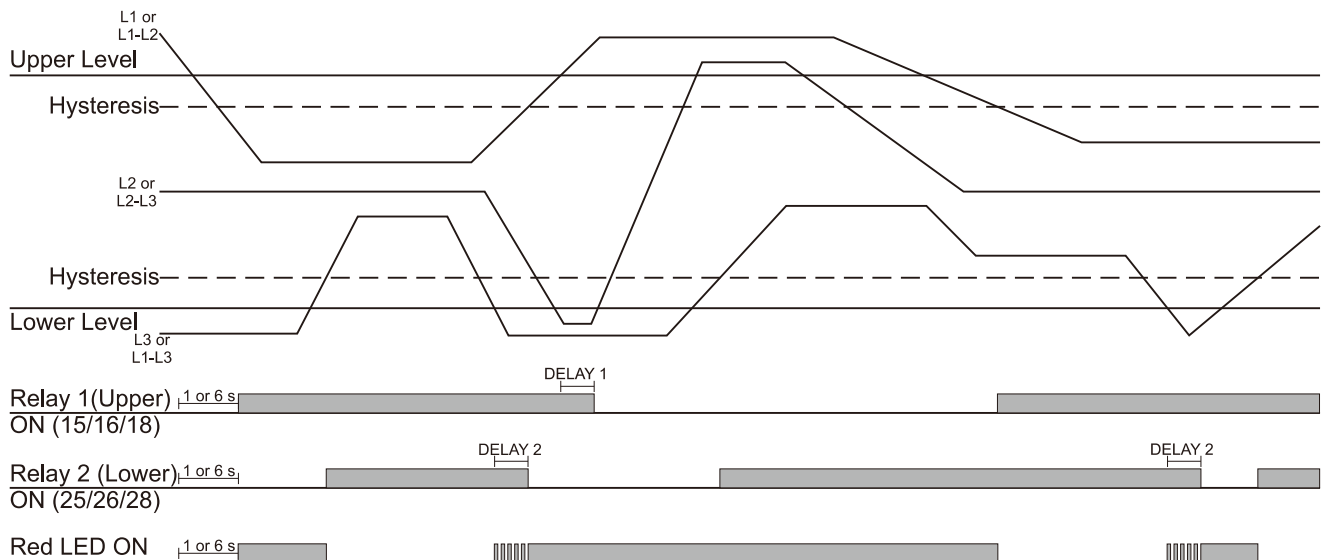

Operation Diagrams (cont.)

Asymmetry and tolerance monitoring (2 x SPDT relays)

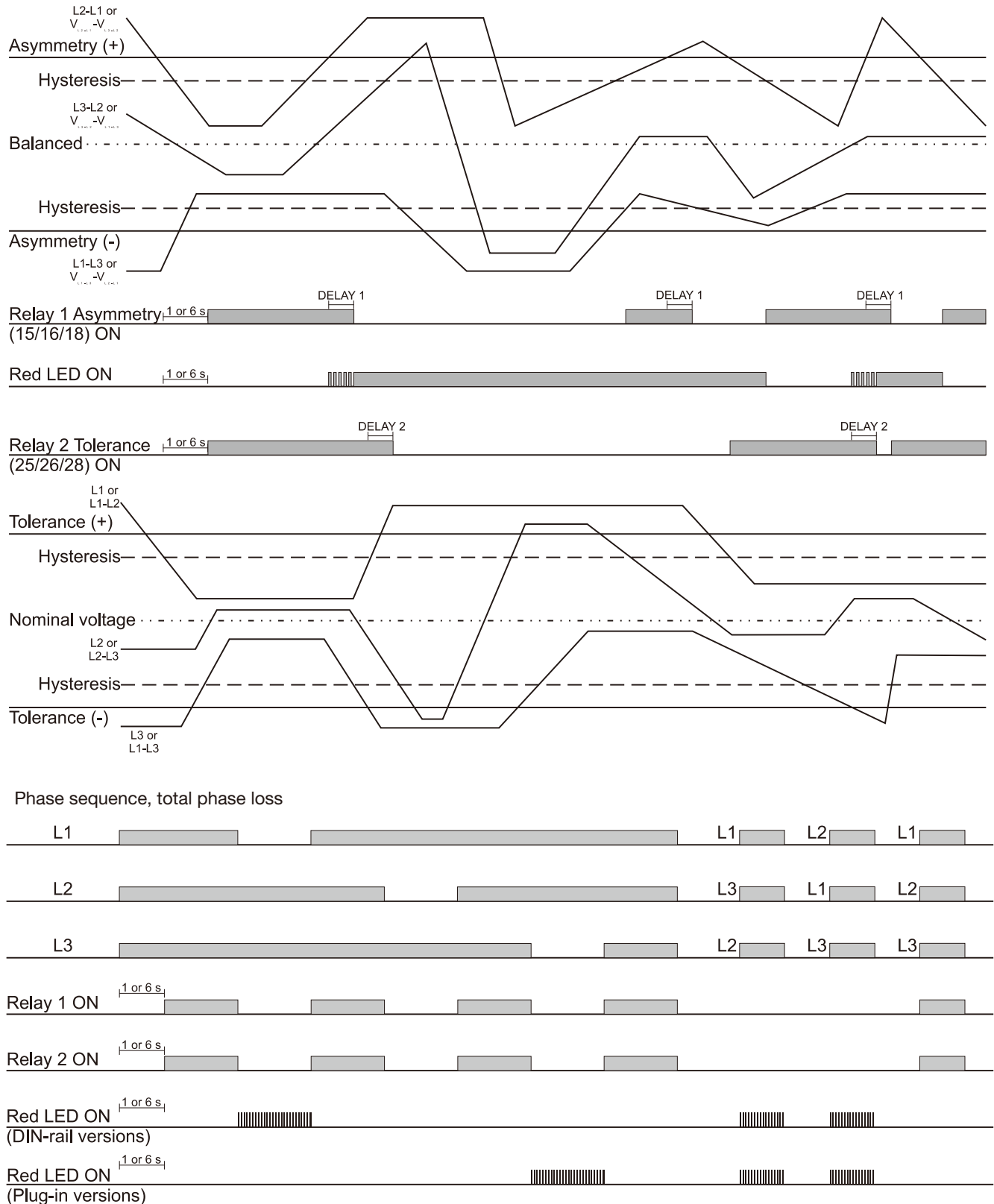

Wiring Diagrams

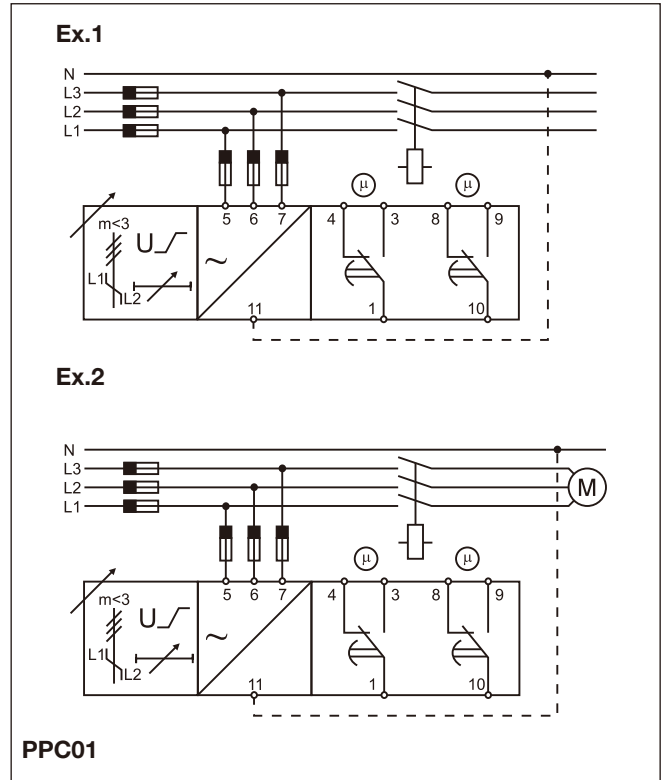
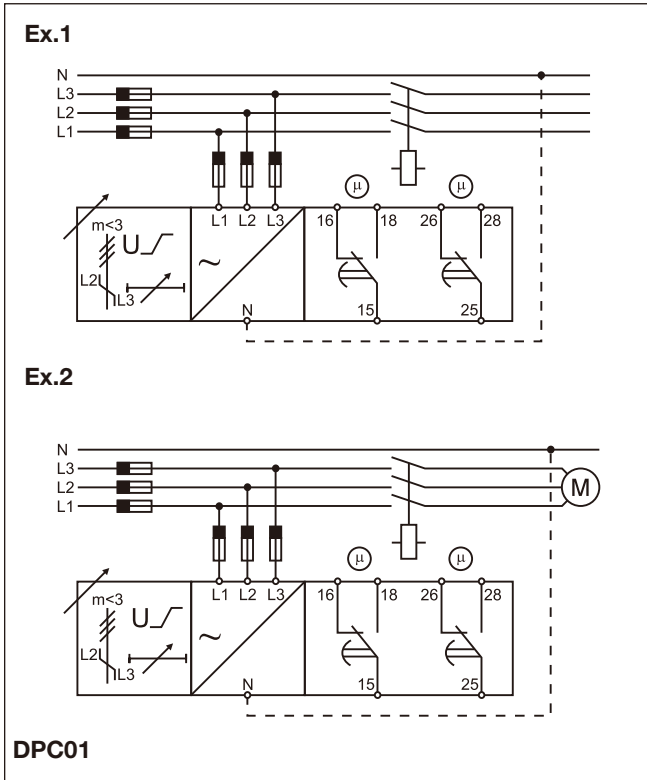

Dimensions

