



日燭科技有限公司  
JD Auspice Co., Ltd.



# 綜合型錄

Products Brochure  
PV BOS

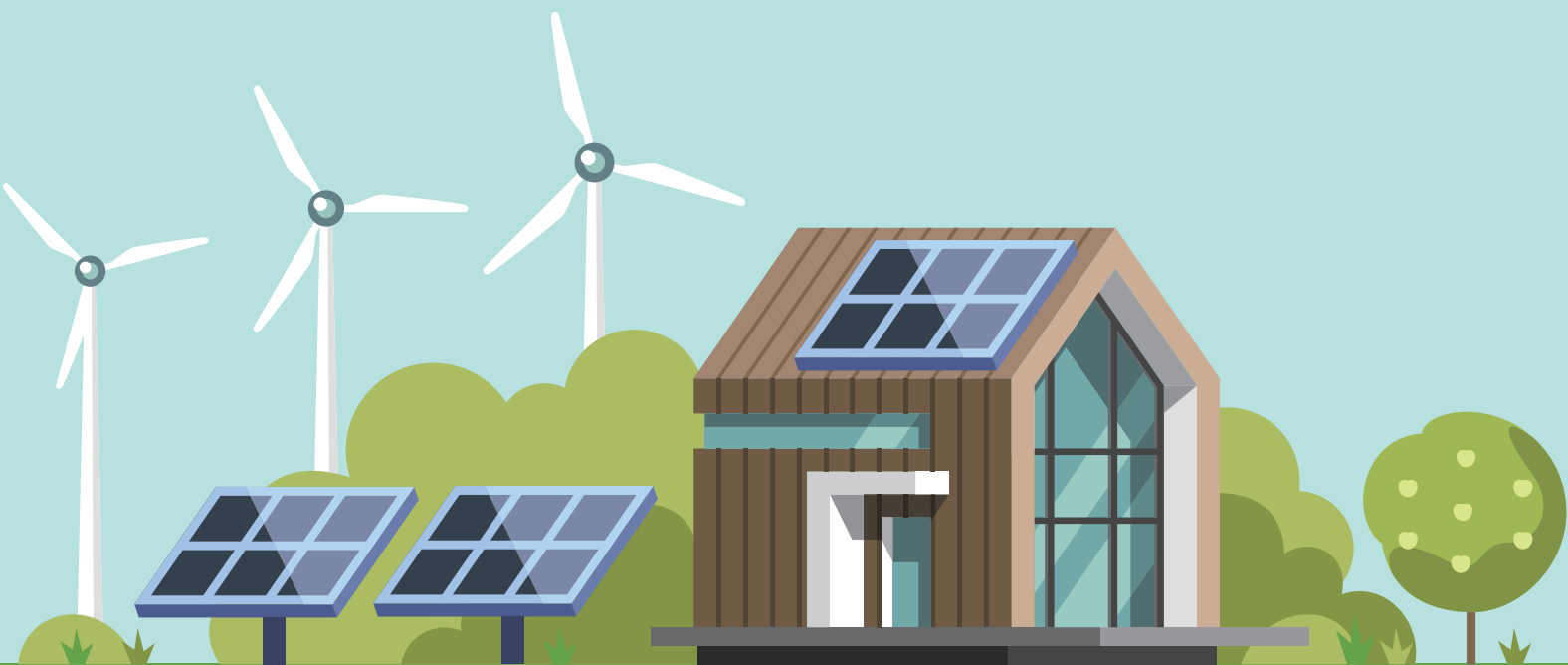

1. 太陽能應用示意圖 Application scheme .....	p03
2. 環境監測系列 Environmental sensors .....	p04
3. 太陽能直流組件系列 Solar BOS series .....	p11
4. 直流斷路器 MCCB for DC Application .....	p35
5. 太陽能發電監測系列 PV farm <b>stringMoni</b> <sup>®</sup> Monitoring system .....	p37
6. 追日控制器 Tracker controller <b>sunOrbit</b> <sup>®</sup> , <b>iMorePV</b> <sup>®</sup> .....	p39
7. 不銹鋼水面太陽能漂浮系統 <b>floSolar</b> <sup>®</sup> Stainless steel floating PV mounting system .....	p40
8. 漂浮光伏系統 <b>floPV</b> <sup>®</sup> Floating PV mounting system HDPE .....	p41
9. 直交流突波吸收器 DC/AC Surge protection device .....	p42
10. 訊號雷擊計數器、訊號突波保護器 Network protector .....	p48
11. 直流開關箱 <b>pvBos</b> <sup>®</sup> PV array Combiner Box .....	p49
12. IP 67 防水箱 IP 67 Enclosure .....	p50
13. 太陽能變流器系列 PV Inverter .....	p51
14. 太陽能功率優化器 <b>mppGuard</b> <sup>®</sup> Optimizer mppGuard .....	p57
15. 阻抗絕緣偵測 Insulation monitoring .....	p58
16. 充電控制器 PV solar charge controller <b>HelliStar</b> <sup>®</sup> .....	p60

太陽能發電用直流平衡系統組件供應商

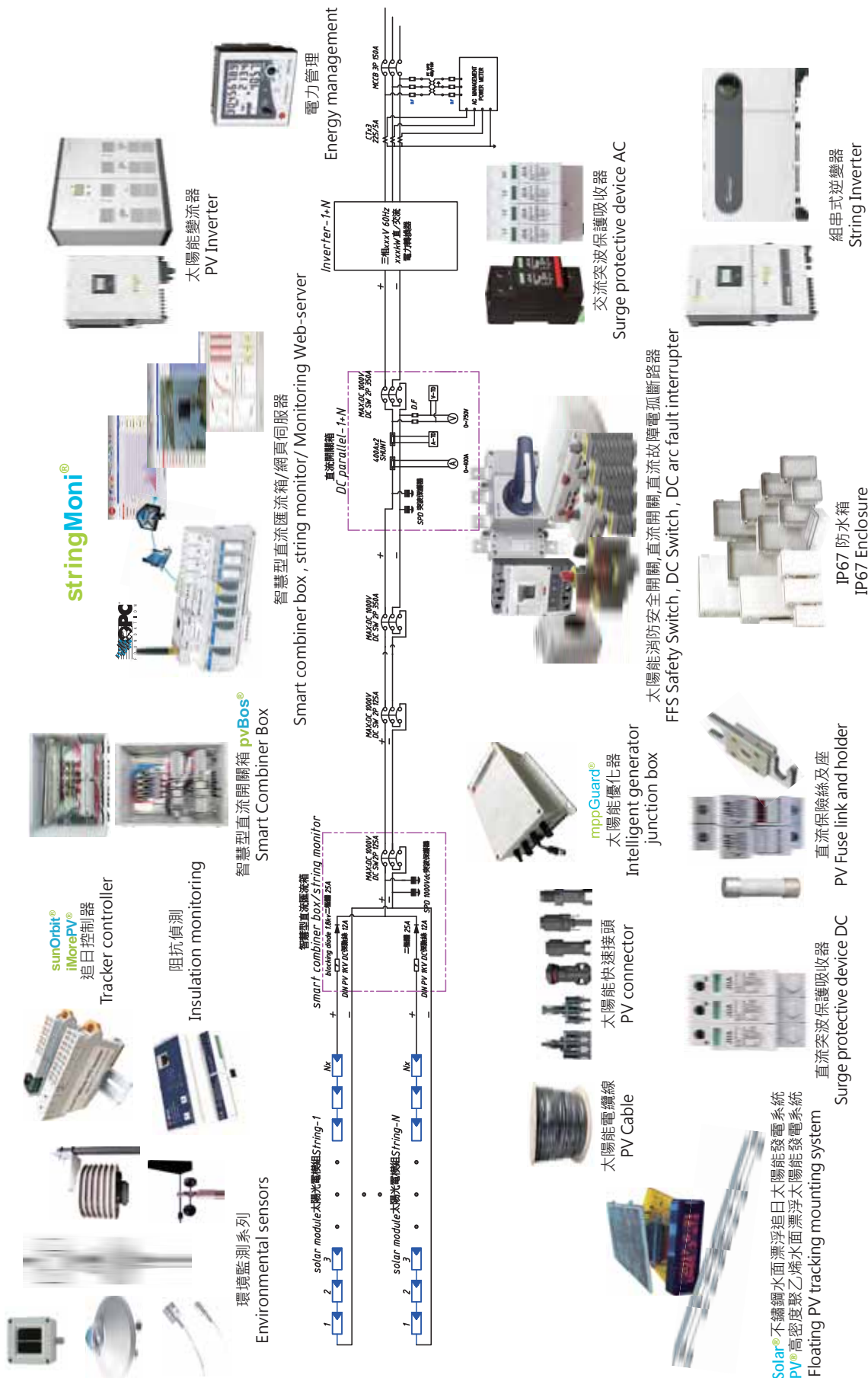



### Pyranometer

日照計 LP 03/03AC/Pyrsi-03 矽晶日照計

日照計

Typical sensitivity : 10MV/(W/m2), output : 4-20mA, Measuring range : 0 ~ 2000W/m2, for Pyrsi-03, 0-1500w/m<sup>2</sup>, Operating temperature: -40°C ~ 60°C, Fully comply with

ISO 9060 second class standards.

全天空輻射計：ISO 9060 等級II · 量測範圍0-2000W/M2 · 輸出4-20mA · 操作溫度-40~+60°C · 反應<30秒。



### Portable pyranometer

攜帶型日照計 LP 471 + Pyra 03.5

Type : LP 471 PYRA 03.5 + HD2302, Typical sensitivity : 10MV/(W/m2), Spectral field : 305nm ~ 2800nm, Measuring range : 0 ~ 2000W/m2, Viewing field : 2πsr, Operating temperature : -40°C ~ 80°C, Fully comply with ISO 9060 second class standards.

靈敏度：10uA/(W/m2) · 光譜範圍：305nm ~ 2800nm · 量測範圍：0 ~ 2000W/m2, 監測角度：2πsr · 工作溫度：-40°C ~ 80°C · 符合ISO9060 second class 標準。



### SolmoTemp / Solar module surface temperature sensor

薄片型溫度感測器 TS-01系列

表面溫度センサー

PT100 3 wire surface temperature sensor for solar module temperature sensing.

厚度3mm × 長50mm × 寬50mm · 線長 1.5~3米(長度另可客製) · 量測範圍：20°C ~ 150°C · 輸入型式3 wire PT100。



### Data Network Protector for high-frequency signal transmission

戶外型溫溼度信號傳送器TH-3200

溫濕度トランスミッター

Measuring range : 0~100%RH, -40~+100°C, output : 4-20mA two wire, power : 12-36VDC > 150mA, ingress protection : IP65.

測量範圍：0~100%RH, -40~+100°C · 訊號輸出：4-20mA two wire · 電壓供給：12-36VDC > 150mA · 防護等級：ABS 耐候外殼 IP65。



### 風速風向計

Wind speed and Direction

風速風向計 WS 420 / 超音波風速計 HD 52.3DP147

風速計

Wind speed : 0-60m/s, Wind direction : 0-360°.

風速計：0-60m/s · 風向計：0-360°。



# PYRANOMETER

Class II ISO 9060

LP PYRA 03/03AC/03AV

Typical sensitivity: 10mV/(W/m<sup>2</sup>), output: 4-20mA,

Measuring range: 0~2000W/m<sup>2</sup>,

Operating temperature: -40°C~80°C,

Fully comply with ISO 9060 second class standards



型號 Model	LP PYRA 03	LP PYRA 03 AC	LP PYRA 03 AV
電源 Power	10...30Vdc	10...30Vdc	10...30Vdc, 15...30Vdc 輸出 0...10Vdc
輸出信號 Output signal	10μV=1W/m <sup>2</sup> 2000W/m <sup>2</sup> =0.02V	4...20mA 4mA=0 W/m <sup>2</sup> 20mA=2000W/m <sup>2</sup>	0...1Vdc, 0...5Vdc, 0...10Vdc 0Vdc=0W/m <sup>2</sup> 1/5/10Vdc=2000W/m <sup>2</sup>
靈敏度 Typical sensitivity	10μV/(W/m <sup>2</sup> )	10μV/(W/m <sup>2</sup> )	10μV/(W/m <sup>2</sup> )
阻抗 Impedance	33Ω ... 45Ω	33Ω ... 45Ω	33Ω ... 45Ω
測量範圍 Measuring range	0...2000W/m <sup>2</sup>	0...2000W/m <sup>2</sup>	0...2000W/m <sup>2</sup>
視場 Viewing field	2πsr	2πsr	2πsr
光譜範圍 Spectral field	305nm...2800nm(50%)	305nm...2800nm(50%)	305nm...2800nm(50%)
操作溫度 Operating temperature	-40°C... +80°C	-40°C... +80°C	-40°C... +80°C
響應時間(95%) Response time (95%)	<30 sec	<30 sec	<30 sec
熱輻射響應(200Wm <sup>2</sup> ) Response to thermal radiation (200Wm <sup>-2</sup> )	25W/m	25W/m	25W/m
溫度變化的響應5K/h Response to temperature change 5K/h	<I±6 I W/m <sup>2</sup>	<I±6 I W/m <sup>2</sup>	<I±6 I W/m <sup>2</sup>
一年後非穩定性 Non stability over 1 year	<I±2.5 I %	<I±2.5 I %	<I±2.5 I %
非線性 Non linearity	<I±2 I %	<I±2 I %	<I±2 I %
餘弦響應 Spectral selectivity	<I±22 I W/m <sup>2</sup>	<I±22 I W/m <sup>2</sup>	<I±22 I W/m <sup>2</sup>
光譜選擇 Response with regard to temperature	<I±7 I %	<I±7 I %	<I±7 I %
溫度響應 Tilt-response	<8%	<8%	<8%
Tilt響應 Risposta in funzione del Tilt	<I±4 I %	<I±4 I %	<I±4 I %
連接線 Cable	CP AA1.5(5m)/CP AA1.10(10m)	CP AA1.5(5m)/CP AA1.10(10m)	CP AA1.5(5m)/CP AA1.10(10m)

# 表面溫度貼片 Solmo Temp 高精度超導 TS-01 系列



適用：各種金屬、塑膠和不規則表面測溫及半導體面板、太陽能板、氣象觀測等。

Applications: Variety of metals, Plastics, Irregularly surface, Semiconductor, Panel, Solar panels, Meteorological observations.

- 使用溫度範圍：-40~+250°C。  
(可訂製更高溫型)  
Measurement Range: -40~+250°C  
(Higher temperature model can be customized)
- 精確度：DIN IEC751 A Class。  
Accuracy: DIN IEC751 A Class
- 超導測溫反應快速、精確度高。  
Fast Response, High Accuracy
- 易於安裝、耐惡劣環境及化學物。  
Easy to Installation  
Resistance to Harsh Environments and Chemicals

## 主要規格 Specifications

外 型：TS-01A 貼附式 / TS-01S 螺絲固定式  
TS-01A (Attachble type) / TS-01S (Screws mounting type)

感 溫 元 件：PT100Ω class A；亦可訂購各式測溫體或熱電偶型式  
PT100Ω Class A (thermocouple type optioned)

貼 片 尺 寸：TS-01A型：10 × 16mm · t = 1mm / TS-01S 型：19 × 22mm · t = 1.5mm  
TS-01A: 10 × 16mm, t = 1.0mm / TS-01S: 19 × 22mm, t = 1.5mm

反 應 速 度：約15秒 ※ 表面完全密貼狀況下  
Approx. 15 sec. ※ Surface completely fit circumstances

導 熱 係 數：低於100°C · ≥ 0.8W/mk · 高於120°C · > 1.5w/mk ASTM D5470  
Lower than 100°C, ≥ 0.8W/mk, Higher than 120°C, > 1.5W/mk

延 伸 信 號 線：耐候型鐵氟龍線；亦可訂製信號線材質、長度  
Climate-bearable for outdoor use (The length can be customized)

## 選購方式 Option Accessories

測溫元件種類： A、白金 PT100Ω/50Ω/1000Ω DIN-Class A  
Platinum PT100Ω/50Ω/1000Ω DIN - Class A

B、熱電偶K、J、E、T、N  
Thermocouple K、J、E、T、N Type

導 線 種 類： 1、PVC導線 2、矽膠導線 3、鐵氟龍導線  
(長度可指定) PVC cable Silicone cable Teflon cable

## 安裝方式 Installation

- a.耐溫超強背膠 Heat-Resistant Adhesive    b.白鐵固定夾 Galvanized Iron Retainer Clip
- c.高溫鋁膠帶 High-Temperature Aluminum Tape    d.螺絲固定孔 Screw Retainer Hole

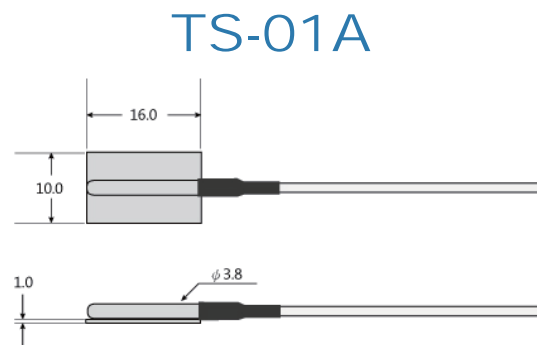
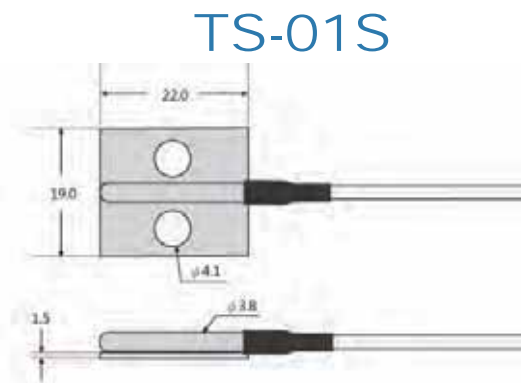

# 溫溼度信號傳送器 戶外型

## TH-3200 series



適用於戶外環境監控、溫室、農業、船運、氣象資料收集、氣候實驗及工業應用之程序控制等。

TRH-3200 series is specially designed to prevent various difficult climates, ensure rapid response and long-term use since it takes advantage of remarkably convection structure of radiation multi-wing and outdoor climate-bear design. At aspects of installation, disassembly, wiring and adjustment, it's more convenient and speedy than other brands.

- 多翼型對流板、防雨、耐候、防止輻射熱。
- 反應迅速、高精度、信號穩定。
- 可選購電流輸出型或電壓輸出型。
- 設計精巧、美觀、容易安裝。

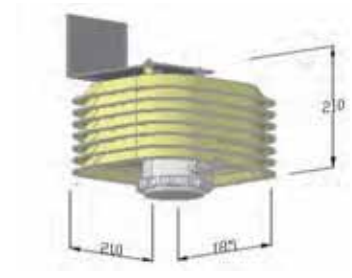

測量範圍 Measurement Range	0 ~ 100 %RH 0 ~ 100°C · -20 ~ +80°C · 0 ~ 50°C · -40 ~ +60°C · 或者其它規格可訂製。
精確度 Accuracy (At 25°C)	±2 %RH · ±0.3°C
穩定條件 Long-term stability	一年內漂移小於 1% RH · (正常使用於安定、無污染環境中)
溫度補償 Temp. Compensation	±0.008 %RH /°C (Effect @ 0% RH)
反應時間 Response	15秒內 (90% at + 25°C in moving air>0.5 M/S)
感測器 Sensors	濕度: Thin-film capacitor 溫度: RTD Pt 100Ω DIN, IEC 751
訊號輸出 Output	電流輸出型(A Type) 溫度: 4 ~ 20 mA Two wire 濕度: 4 ~ 20 mA Two wire 電壓輸出型(V Type) 可選購 0 to 1 V · 0 to 2V · 0 to 5 V · 0 to 10 V或1 to 5V 輸出
電壓供給 Power Supply	12 ~ 36 V DC > 150mA
感測器保護 Housing / Protection	裝置於戶外用多翼輻射耐候盒 · 內置防塵、防干擾過濾罩。
主器外殼 Internal transmitter	ABS耐候外殼 · 防護等級 IP65°
結線器 Cable gland	防水型快速結線器及端子座 · 適用結線外徑: φ5 ~ 10 mm°
主器周圍環境溫度 Ambient Temperature	-40 ~ +85°C · (-40 ~ +185)°F
重量 Weight	約 1500公克
外型及尺寸 Dimensions (不含固定座)	210 (L) × 185 (W) × 210 (H) mm 基座具固定孔

訂購說明 [例] TH-3203A: 溫、濕度傳送器 · 電流輸出型。

機 型 代 號		功 能 內 容	
TH-3201		Temperature Transmitter 溫度信號傳送器	
TH-3202		Humidity Transmitter 濕度信號傳送器	
TH-3203		Temp./Humi Transmitter 溫、濕度信號傳送器	
輸 出	A	Current Output 電流輸出型	
	V	Voltage Output 電壓輸出型	

※以上規格內容之修改、變更，將不另行通知。



### Combined Wind speed and Direction sensors

Combined wind speed and wind direction sensor. Direct signal output for wind speed (Hz) and wind direction (0÷1 Vdc). This sensor range includes, in a single apparatus, transducers for both wind speed and wind direction measurement. Its use simplifies installation requirements, other than being smaller, lighter and cheaper than the general 2-sensor kit. Model WS122#S is equipped with a potentiometer and its wind direction output is in  $\Omega$ , with very low power consumption and it can be used in applications with limited energy availability. Data output of the WS921 model is RS485 using Modbus RTU® or TTY-ASCII protocols.

Order numb.	WS833.01	WS833.2000	WS420	WS05	WS485
Wind speed output	0÷833 Hz		4±20 mA	0÷5 Vdc	RS485
Wind speed measuring range	0÷75 m/s (damage limit)		0÷60 m/s		
Wind Direction output	0÷1 Vdc	0÷2000 $\Omega$	4±20 mA	0÷5 Vdc	RS485
Protocol	-	-	-	-	Modbus RTU® TTY-ASCII
WS Programmable output	-	-	-	-	Instant, max., min., ave. (1÷3600 sec)
WD programmable output	-	-	-	-	Instant, Prevalent sector (1÷3600 sec)
Configuration	-	-	-	-	Hyperterminal
Protection	Tranzorb		Tranzorb e Emifilters		
RS485 protection	-	-	-	-	Galvanic insulation (3 kV, UL1577)
RS485 speed	-	-	-	-	1200÷115 kbps
Power supply	12 Vdc		10÷30 Vac/dc		
Power consumption	30 mA	2 mA	0,5 W		
Wind direction principle	Hall effect system	2 k $\Omega$ potentiom.	Hall effect system		
Data logger compatibility	M-Log (ELO007-008) R-Log (ELR515) E/X-Log (all models)		-	-	-
<b>Common features</b>					
Wind speed	Principle		N.32 step optoelectronic disk		
	Accuracy		0÷3 m/s=1,5%, >3 m/s= 1%		
	Threshold		0,26 m/s		
	Delay distance		4,8 m (@ 10 m/s) According to VDI3786 and ASTM 5096-96		
	Resolution		0,07 m/s		

# HD 52.3D

## 2 AXES ULTRASONIC ANEMOMETERS



axes ultrasonic Anemometers series HD 52.3D....

The instruments of the series HD52.3D... are 2 axes ultrasonic static anemometers for measuring:

- Wind speed and direction, U-V Cartesian components of wind speed,
- Relative Humidity and Temperature (optional, code '17'),
- Diffuse Solar Radiation (optional, code 'P'),
- Barometric pressure (optional, code '4').

All models are equipped with compass.

RS232, RS485, RS422 and SDI-12 serial interfaces are available with NMEA,MODBUS-RTU and SDI-12 communication protocols.

All versions have two analogical outputs, both for wind speed and for direction, factory configurable among 4÷20mA (standard), 0÷1V, 0÷5V, 0÷10V (to be specified when ordering).

Optionally available, (ACCREDIA) ILAC-MRA traceable factory calibration.

Typical applications:

- Weather stations • Environmental monitoring
- Agriculture • Marine and Harbour applications
- Sports facility • Airports • HVAC • Construction
- Renewable energy • Building automation

Advantages:

- The absence of moving parts minimizes maintenance;
- High sensitivity for detecting very low speeds, which are not detectable by traditional methods;
- The low power of the instrument allows installation in remote sites, with power from solar panel and battery;
- The heating option 'R' prevents the accumulation of snow and ice from forming, allowing accurate measurements in all environmental conditions;
- Fast and easy installation (on 40mm diameter pole, optional installation kit HD2004.20), alignment facilitated by built-in compass;
- The available measurement options join together in one single, compact and lightweight instrument, the main variables of interest in weather stations;
- MODBUS-RTU output allows instrument networking.

Technical specifications:

Wind speed	
Employed sensor type	Ultrasonic
Measuring Range	0...60 m/s
Resolution	0.01 m/s
Accuracy	Whichever is greater $\pm 0,2$ m/s or $\pm 2\%$ , (0...35 m/s) $\pm 3\%$ (> 35 m/s)
Wind direction	
Employed sensor type	Ultrasonic
Measuring Range	0...360°
Resolution	0.1°
Accuracy	$\pm 2^\circ$ RMSE from 1.0 m/s
Compass	
Employed sensor type	Magnetic
Measuring Range	0...360°
Resolution	0.1°
Accuracy	$\pm 1^\circ$
Air temperature (option 17 is requested)	
Employed sensor type	Pt100
Measuring Range	-40...+60 °C
Resolution	0.1 °C
Accuracy	$\pm 0,15^\circ\text{C} \pm 0,1\%$ of the measure
Relative Humidity (option 17 is requested)	
Employed sensor type	Capacitive
Measuring Range	0...100%RH
Resolution	0.1%
Accuracy (@ T = 15...35 °C)	$\pm 1,5\%$ UR (0...90%RH), $\pm 2\%$ RH (remaining fi eld)
Accuracy (@ T = -40...+60 °C)	$\pm (1,5 + 1,5\%$ of the measure)%RH
Barometric Pressure (option 4 is requested)	
Principle	Piezoresistive
Measuring Rang	600...1100 hPa
Resolution	0.1 hPa
Accuracy	$\pm 0,5$ hPa @ 20°C
Solar Radiation (option P is requested)	
Employed sensor type	Thermopile
Measuring Rang	0...2000 W/m <sup>2</sup>
Resolution	1 W/m <sup>2</sup>
Accuracy	2 <sup>nd</sup> class Pyranometer
General features	
Power supply	10...30 Vdc
Power Consumptio	26mA @ 12Vdc without heater, 6W with heater
Serial Outputs	RS232, RS485, RS422 and SDI-12
Communication Protocols	NMEA, MODBUS-RTU, SDI-12
Analog Outputs	2 analog outputs for wind speed and direction. Output type to be speci fi ed when ordering among 4...20mA(standard), 0...1V, 0...5V and 0...10V <b>(option 0...10V requires power supply 15...30Vdc)</b>
Electrical connection	male connector M23 19 poles
Working temperature	-40...+60 °C
Dimensions	H=179mm, Ø =150mm (HD52.3D, HD52.3D4) H=200mm, Ø =150mm (HD52.3DP, HD52.3DP4) H=336mm, Ø =150mm (HD52.3D17, HD52.3D147) H=357mm, Ø =150mm (HD52.3DP17, HD52.3DP147) about 1 Kg (full version, HD52.3DP147)
Housing	Plastic material: LURAN®S (ASA) Metallic parts made of AISI 316
Protection degree	IP66



# 環境監測箱

環境監測箱所收集的日照、溫度、風速等數據，可以更精確判斷太陽能電廠的PR值與模組的發電效率，除了掌握電廠的運作狀況外也讓電廠的維運作業有所依據。

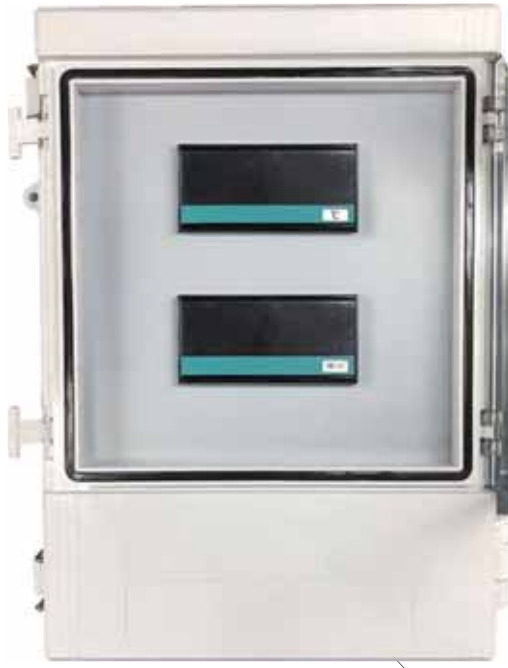

- 日照錶，輸入訊號4-20mA / 0-10V，輸出訊號RS485
- 溫度錶，輸入訊號4-20mA / PT100，輸出訊號RS485
- 供應電源AC115-230V



安裝操作簡單  
內藏操作按鍵設計，避免人為疏失



- 日照錶，輸入訊號4-20mA / 0-10V，輸出訊號RS485
- 溫度錶，輸入訊號4-20mA / PT100，輸出訊號RS485
- 風速錶，輸入訊號4-20mA，輸出訊號RS485，供應電源AC115-230V
- 大氣溫度錶



可根據現場需求任意設定顯示範圍  
端子直入設計，無接觸不良問題；安裝深度只有72mm







### Fuse holder 1000Vdc / 1500Vdc

直流保險絲座 FH-01

DC ヒューズホルダー

直流熔絲座：1000~1500Vdc 30A, 操作度-20 ~ +70C, IEC60947-1/3  
適用直流保險絲：900Vdc (900Vdc, Tested 1000Vdc) 1,2,4,6,8,10,12,16, 20,25,30A 10x38mm。



### gPV fuse link / forklift truck and battery fuse

直流保險絲 / 蓄電儲能保險絲

gPV ヒューズ

直流保險絲：1000~1500Vdc tested 1000Vdc：1,2,4,6,8,10,12,16,20,25,30A, 10 x 38mm.  
1000Vdc：1,2,4,6,8,10,12,16,20,25A, 10 x 38mm. IEC60269-6。  
1000Vdc：1,2,4,6,10,16,20,25,32,40,50, 22 x 127 mm. IEC60269-6。  
蓄電儲能保險絲：35~600A, 80~130Vdc



### DC Switch disconnect

直流開關 XA type / XB type

DCスイッチ

16~2000Amp, 600-1000Vdc, Passed UL.IEC.KEMA.CE.BC.CSA.CC safety standard.  
16~2000Amp · 600-1000Vdc · 通過UL、IEC、KEMA、CE、BC、CSA、CCC認證。  
雙軸非同步儲能驅動·雙刀圓盤接點橋·無伸張電弧·可安全的直接電壓下使用·自我清潔接點·高速氣流冷卻技術·符合國際環保規定·不含鉛鎘·體積小·多種安裝選擇。



### DC MCCB / DC Switch

直流斷路器

DC遮斷機

DC MCCB：DC1000V 2P。



### DC MCCB / DC Switch

直流斷路器

DC遮斷機

DC MCCB：500~1000V, 16~2000A, DC Switch：500~1000V, 16~2000A · TUV  
直流斷路器：500~1000V, 16~2000A。

## SOLAR PV FUSE HOLDER FOR CYLINDRICAL FUSE-LINKS SIZE 10x38, DC DESIGN



- Fuse disconnectors FH are intended for cylindrical fuse-links size 10x38.
- Fuse disconnectors FH can be sealed in the closed state.
- The devices are designed as modular for 45 mm cut out in the switchboard.



### Dimensions FH01 /Din rail mounting

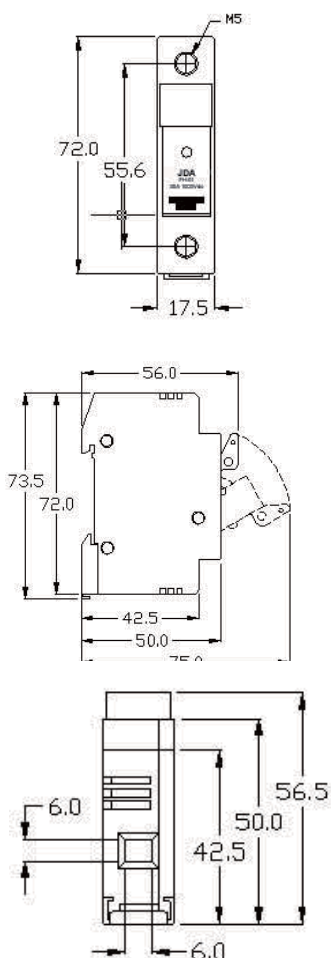

Part No	$I_n$ [A]	Rate Voltage	Number of poles	Package[pcs]
FH-01	30	1000Vdc	1	12
FH-01L	30	1000Vdc	1	12

Note: FH-01-L with status light, without status light FH-01

Parameters		
Rated operating current	$I_n$	30 A
Rated operating voltage	$U_c$	1000 V d.c.
Utilization category		DC-20B
Rated insulation voltage	$U_i$	1000 V d.c. <sup>(1)</sup>
Rated pulse withstand voltage	$U_{imp}$	4KV
Fuse-link	Diameter x length	10x38
Max. rated current of the fuse-link		30A
Max. power losses of the fuse-link		3W
Rated short-time withstand current	$I_{cw} 1s$	1.6KA
Electrical endurance (operating cycles)		300
Mechanical endurance (operating cycles)		1700
Degree of protection, cover closed		IP20
Degree of protection, cover opened		IP20
Connection cross-section		Cu $\phi$ 0.5+25mm <sup>2</sup> (2x16mm <sup>2</sup> )
Torque		2 Nm
Operating ambient temperature	t	-25+55°C
Max. sea level		2000m
Material body and handle		thermoplastic high resistance to the temperature,PBT
Flammability		UL 94 - V0
Glow Wire Test		IEC 60695 , 960 °C
Colour		Ral 7035
Material of contacts		electrolytic silver plated copper or Phosphor bronze.
Standards		IEC 60947-1,-3 ; EN 60947-1,-3

Note: (1) also suitable for 695Vac. application

## CH 10 gPV - Fuse - links

General characteristics		UL file: E347771
Rated voltage	1000V d.c. L/R=2ms	
Breaking capacity	10kA d.c. /30kA d.c.	
Standards	UL 2579, UL 248-1	
Application	For protection of photovoltaic modules.	



CH 10x38 gPV										
Size	$I_n$ [A]	Code No. "standard contacts" 10kA UL	Code No. "standard contacts" 30kA IEC	Code No. "type SU contacts" 30kA IEC	Pre-arcing Joule integral [As] L/R=2ms	Operating Joule integral [As] L/R=2ms	Power dissipation [0,7 x <sub>1</sub> ] P <sub>d</sub> [W]	Power dissipation [I <sub>n</sub> ] P <sub>d</sub> [W]	Weight [g]	Packaging [pcs]
10 x 38	0,5		002625134	002625131	0,016	0,068	0,2	0,52	10/12	10/500 SU:10/380
	1		002625138	002625129	1,5	3	0,42	1,0		
	2	002625101	002625065	002625115	1,7	2,3	0,47	1,12		
	3	002625100	002625067	002625113	2,8	5,4	0,65	1,6		
	3,5	002625135	002625068	002625127	2,5	7	0,57	1,4		
	4	002625102	002625069	002625116	3,9	11,7	0,52	1,25		
	5	002625111	002625070	002625124	8	21	0,63	1,49		
	6	002625103	002625071	002625117	10,6	34,6	0,73	1,75		
	7	002625110	002625072	002625114	16	60	0,74	1,74		
	8	002625104	002625073	002625118	17	65	0,8	1,9		
	10	002625105	002625075	002625119	8,3	33	0,97	2,4		
	12	002625106	002625077	002625120	22	73	0,8	1,9		
	13	002625137	002625078	002625128	21	70	1,0	2,3		
	14	002625136	002625079	002625126	28	92	1,3	3,0		
	15	002625112	002625080	002625125	49	145	1,0	2,2		
	16	002625107	002625081	002625121	48	147	1,1	2,6		
	20	002625108	002625085	002625122	86	245	1,3	3,2		
25*		002625109	002625123	125	289	1,65	4,1			
25		002625139	002625140	110	470	1,65	4,1			

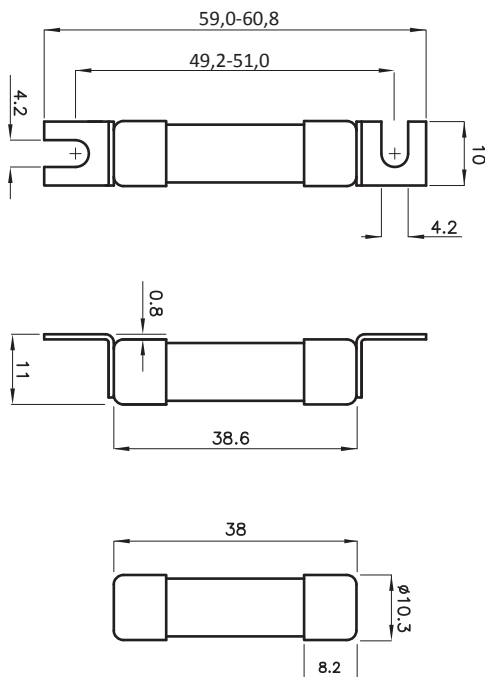

Standard Contacts



Type SU Contacts

### IEC60947-3 直流開關 PV1

Amp Ratings Santon IEC 60947 1&3		Means certified								
Update 9-8-2018		Means calculated ratings								
Certified for	DC 21 B	DC 21 B	PV 1	PV1	DC 21 B	DC 21 B	PV 1	DC 21 B	PV 1	
Switch type	XA	XBE	XBE+	XBE+	XB	XBHP	XBHP+	XC	XC+	
# poles	12	6	8	8	6	6	8	8	8	
CCC	Yes	Yes	Yes	Yes	Yes	Yes	Yes	Yes	Pending	
Volt	Use with									
1500	combined								20	20
1450	minus								23	23
1400	pole per								26	26
1350	2 MPPT								29	29
1300	3 pole or								32	32
1250	6 pole								35	35
1200									20	38
1150									22,5	41
1100									10	25
1050									13	6,5
1000	16	10	16	8	16	20	30	50	50	
950	17,3	11,25	18,25	9,125	17,3	22,5	28,75	50	52,5	
900	18,7	12,5	20,5	10,25	18,7	25	32,5	50	55	
850	20	13,75	22,75	11,375	20	27,5	36,25	50	57,5	
800	25	15	25	12,5	25	30	40	50	60	
750	27,3	18,3	29,2	14,6	26,7	32,5	42,5	50	60	
700	29,7	21,7	33,4	16,7	28,4	35	45	50	60	
650	32	25	37,5	18,75	30	37,5	47,5	50	60	
600	32	25	41,7	20,85	33	40	50	50	60	
550	32	25	45,9	22,95	36	42,5	50	50	60	
500	32	25	50	25	39	45	50	50	60	
450	32	25	50	25	42	45	50	50	60	
400	32	25	50	25	45	45	50	50	60	
350	32	25	50	25	45	45	50	50	60	
300	32	25	50	25	45	45	50	50	60	
250	32	25	50	25	45	45	50	50	60	
200	32	25	50	25	45	45	50	50	60	
150	32	25	50	25	45	45	50	50	60	
100	32	25	50	25	45	45	50	50	60	
50	32	25	50	25	45	45	50	50	60	

### UL508i RATED SWITCHES (cCSAus)

SANTON	UL 508 i ratings									
Type	XA	XBUE	XBU	XBUHP	X	XC UL	XC UL	XC UL	XC UL	XC UL
# circuits +/-	1-6	1-4	1-4	1-4	1-6	1-4	1-4	1-4	1-6	1-3
# decks/circuit	2	2	2	2	2	2	2	2	2	3
Combine 2 - poles	No	No	No	No	No	No	No	No	No	No
# poles	2-12	2-8	2-8	2-8	2-12	2-8	2-8	2-8	2-12	2-6
CCC	Yes	Yes	Yes	Yes	Yes	Yes	Yes	Yes	No	No
1500 V									13 A	12 A
1400 V										
1300 V										
1250 V									21 A	21 A
1200 V										
1100 V										
1000 V						20 A	30 A	30 A		50 A
900 V										
850 V										
800 V									40 A	
750 V						40 A	50 A	50 A		
700 V										
650 V										
600 V	25 A	25 A	30 A	36 A	30 A					
500 V										
400 V										
300 V										
200 V										
100 V										
0 V										

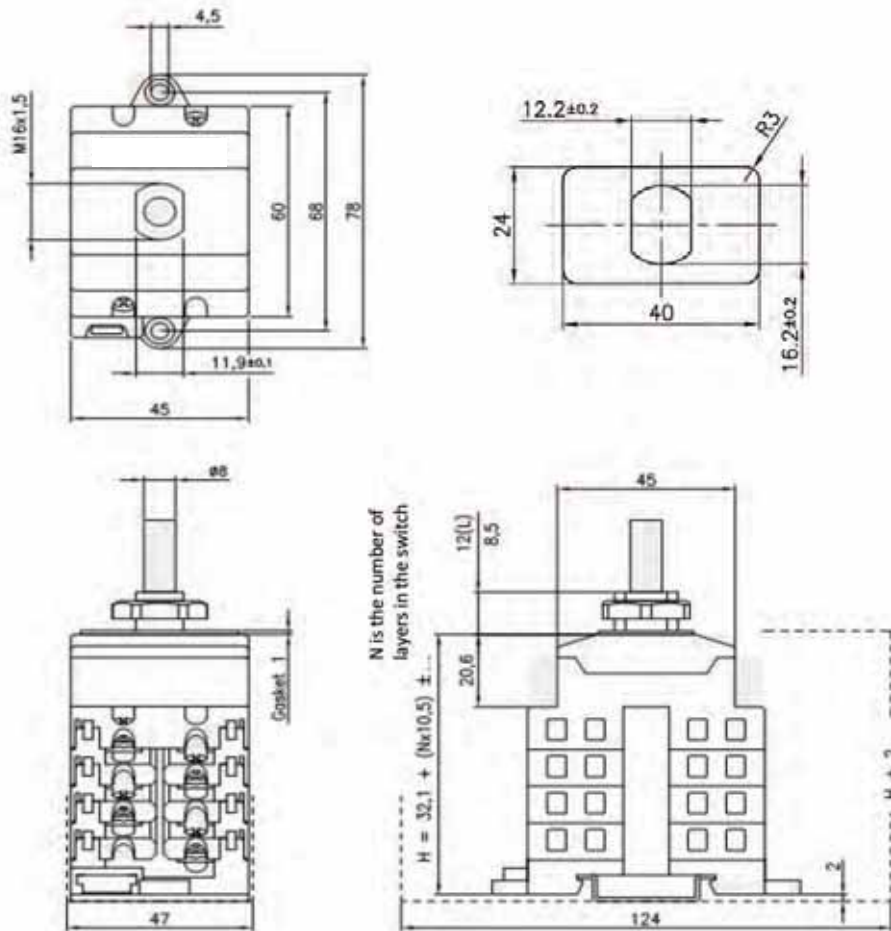

**Mounting instructions**

In the application all ratings have to be respected. When building the switch in an enclosure, the space envelope must be respected according to the applicable standards. The terminals, without interconnection can take copper wires up to 6 mm<sup>2</sup>. The recommended Spade Tongue Terminals may have a maximum width of 9 mm. For CSA and UL applications, registered Spade Tongue Terminals must be used. The registration numbers are UL: E13288 and CSA: LR7189 (for instance type 165015 from Tyco). After mounting, the wiring must be checked and the switch must operate smoothly.

**Maintenance**

- The X type switches are designed for a very long life but it is advised to do some simple yearly maintenance.
- Check the installation for signs of overload or overheating. The terminals may not exceed the limit of 85 °C under full load.
  - By operating the switch a few times (5x) the contacts will clean themselves and the switch will have a longer life.

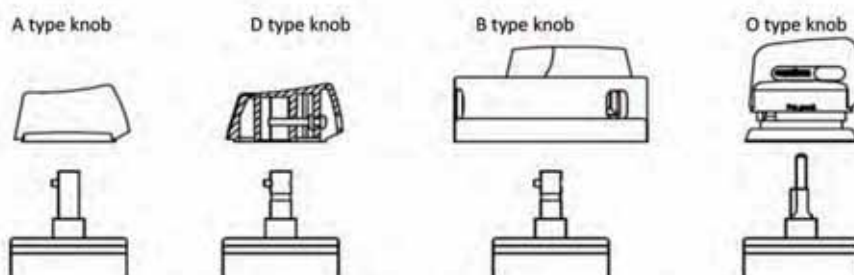

Dimensions, specifications and data shown could be subject to change without notice.



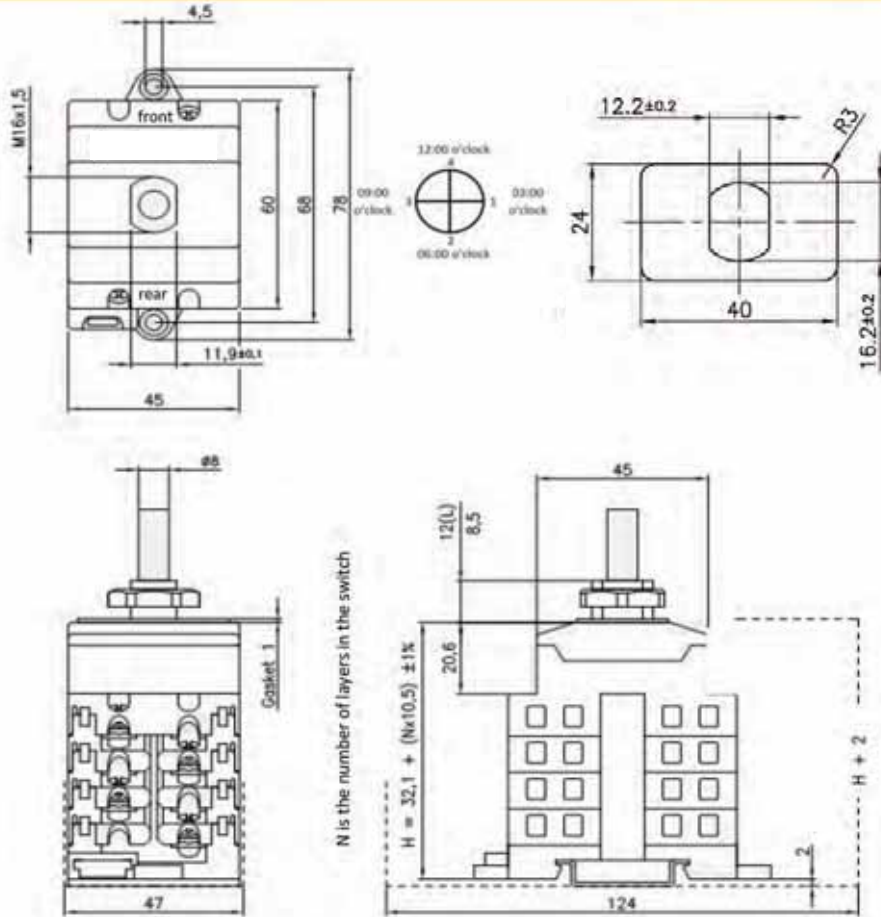

**Mounting instructions**

In the application all ratings according to the datasheet have to be respected. After mounting, the wiring must be checked and the switch must operate smoothly. When building the switch in an enclosure, the space envelope must be respected according to the applicable standards.

**Maintenance**

The X type switches are designed for a very long life but it is advised to do some simple yearly maintenance.

- Check the installation for signs of overload or overheating. The terminals may not exceed the limit of 85 °C under full load.
- By operating the switch a few times (5x) the contacts will clean themselves and the switch will have a longer life.

**Connection details**

Description	Symbol	Values				Unit
Rated operational current (DC poles)	Ie	16	20	25	32	A dc
Required fine wire cross-section (minimal): IEC60947-1, table 9	A	2,5	4	4	6	mm <sup>2</sup>
max power dissipation	P	1,9	3,0	4,8	7,8	W

The terminals, without interconnection can take copper wires up to 6 mm<sup>2</sup>.  
The recommended Spade Tongue Terminals may have a maximum width of 9 mm.  
For CSA and UL applications, registered Spade Tongue Terminals must be used.  
The registration numbers are UL: E13288 and CSA: LR7189 (for instance type 165015 from Tyco).

**Registered Spade Tongue Terminals**

Recommend Manufacturer	Type number	Wire size (AWG)	Wire size (mm <sup>2</sup> )	Color
JST	FVD2-Y54A	AWG 16 – AWG 14	1,0 – 2,5 mm <sup>2</sup>	Blue
TE connectivity	C-165012	AWG 16 – AWG 14	1,0 – 2,5 mm <sup>2</sup>	Blue
Vogt	3635c	AWG 16 – AWG 14	1,5 – 2,5 mm <sup>2</sup>	Blue
TE connectivity	C-165015	AWG 12 - AWG 10	3,0 - 6,0 mm <sup>2</sup>	Yellow
Vogt	3652c / 3653c	AWG 12 - AWG 10	3,0 - 6,0 mm <sup>2</sup>	Yellow
Santon (JST)	52A1256.35	AWG 8 - AWG 10	10,5mm <sup>2</sup> -16mm <sup>2</sup> *1	*2

\*1 16mm<sup>2</sup> only with fine stranded wire or two 6mm<sup>2</sup> is also possible

\*2 Optional: A yellow finger safe sleeve for the Spade Tongue Terminal (Santon 52A1256.35) can be ordered under item number 52A1564.00



# Data Sheet

Santon X-Type switch X100.40DL2E-A

Switch disconnecter for solar application according to IEC 60947-1&3 by Dekra (KEMA) and CCC (CQC)



Empty for better insulation  
N = number of contact layer



Terminals Scheme									
Layer No.	Front Side		Symbol	Rear Side On Positions					
	Left	Right		Left	Right	1	2	3	4
4			-1			X			
3							X		
2							X		
1			empty						

Contacts are made in "X" marked position.  
Symbols for interconnection: |

Technical data	Symbol	Merit	Unit
rated operational voltage (DC poles)	Ue		1000 V dc
rated operational current (DC poles)	Ie		40 A dc
rated operational voltage (second rating DC poles, if requested)	Ue		V dc
rated operational current (second rating DC poles, if requested)	Ie		A dc
rated operational voltage (third rating DC poles, if requested)	Ue		V dc
rated operational current (third rating DC poles, if requested)	Ie		A dc
rated operational voltage (fourth rating DC poles, if requested)	Ue		V dc
rated operational current (fourth rating DC poles, if requested)	Ie		A dc
method of mounting	both bottom and single hole mounting [D]		
number of DC poles			2
utilization category DC	DC-21B		
actuator	standard black [A]		
positions	OFF at 12 hr, ON at 3 hr [E]		
rated impulse withstand voltage	Uimp		8 kV
insulation voltage	Ui		1000 V
rated thermal current uninterrupted duty	Iu		40 A
rated short-time withstand current (1s)	Icw		750 A
rated short-circuit making capacity	Icm		1.4 kA
rated conditional short-circuit current			5 kA
method of operation	independent manual operation		
minimum required dimensions of enclosures L x W x H* (on DIN-rail H = +2mm) (space envelope)			124 x 47 x 74.1 mm
* see the drawing for the height of the switch. The number of layers N is:			4
knob operation force		max.	1.4 Nm
tightening torque terminal screws M4, min. - max.		1.5	1.7 Nm
tightening torque panel mounting nut, min. - max.		2.0	2.5 Nm
tightening torque M3 screw in the standard black knob, min. - max.		0.5	0.7 Nm
ambient temperature allowed between			-40 to +70 °C
storage temperature allowed between			-40 to +80 °C
maximum relative humidity, without condensation at 20 °C			90 %
pollution degree			2
IP rating terminals			IP20
IP rating gland of the shaft in case of single hole panel mounting			IP65
rated operational voltage (AC poles)	Ue		V ac
rated operational current (AC poles)	Ie		A ac
number of AC poles (for general use)			
minimum required fine wire cross-section: IEC60947-1, table 9			mm <sup>2</sup>
auxiliary contact(s), AC15			No auxiliary contact
auxiliary contact ratings			
weight			221 g
accessories:			

Data Sheet

Santon X-Type switch X100.40DL4E-A

Switch disconnecter for solar application according to IEC 60947-1&3 by Dekra (KEMA) and CCC (CQC)



Empty for better insulation  
N = number of contact layer



Terminals Scheme										
Layer No.	Front Side		Symbol	Rear Side		On Positions				
	Left	Right		Left	Right	1	2	3	4	
7										
6										
5		-2			-2			X		
4			-1			-1		X		
3								X		
2								X		
1										

Contacts are made in "X" marked position.  
Symbols for interconnection: ]

Technical data	Symbol	Merit	Unit
rated operational voltage (DC poles)	Ue		1000 V dc
rated operational current (DC poles)	Ie		40 A dc
rated operational voltage (second rating DC poles, if requested)	Ue		V dc
rated operational current (second rating DC poles, if requested)	Ie		A dc
rated operational voltage (third rating DC poles, if requested)	Ue		V dc
rated operational current (third rating DC poles, if requested)	Ie		A dc
rated operational voltage (fourth rating DC poles, if requested)	Ue		V dc
rated operational current (fourth rating DC poles, if requested)	Ie		A dc
method of mounting		both bottom and single hole mounting [D]	
number of DC poles			4
utilization category DC	DC-21B		
actuator	standard black [A]		
positions	OFF at 12 hr, ON at 3 hr [E]		
rated impulse withstand voltage	Uimp		8 kV
insulation voltage	Ui		1000 V
rated thermal current uninterrupted duty	Iu		40 A
rated short-time withstand current (1s)	Icw		750 A
rated short-circuit making capacity	Icm		1.4 kA
rated conditional short-circuit current			5 kA
method of operation	independent manual operation		
minimum required dimensions of enclosures L x W x H* (on DIN-rail H = +2mm) (space envelope)			124 x 47 x 105.6 mm
* see the drawing for the height of the switch. The number of layers N is:			7
knob operation force		max.	1.4 Nm
tightening torque terminal screws M4, min. - max.		1.5	1.7 Nm
tightening torque panel mounting nut, min. - max.		2.0	2.5 Nm
tightening torque M3 screw in the standard black knob, min. - max.		0.5	0.7 Nm
ambient temperature allowed between			-40 to +70 °C
storage temperature allowed between			-40 to +80 °C
maximum relative humidity, without condensation at 20°C			90 %
pollution degree			2
IP rating terminals			IP20
IP rating gland of the shaft in case of single hole panel mounting			IP65
rated operational voltage (AC poles)	Ue		V ac
rated operational current (AC poles)	Ie		A ac
number of AC poles (for general use)			
minimum required fine wire cross-section: IEC60947-1, table 9			mm <sup>2</sup>
auxiliary contact(s), AC15			No auxiliary contact
auxiliary contact ratings			
weight			315 g
accessories:			



Data Sheet

Santon X-Type switch XA100.16DL10E-A

Switch disconnecter for solar application according to IEC 60947-1&3 by Dekra (KEMA) and CCC (CQC)



Empty for better insulation  
N = number of contact layer



Terminals Scheme							
Layer No.	Front Side		Symbol	Rear Side		On Positions	
	Left	Right		Left	Right	1	2 3 4
11	-5			-5		X	
10		+5			+5	X	
9	+4			+4		X	
8		-4			-4	X	
7	-3			-3		X	
6		+3			+3	X	
5	+2			+2		X	
4		-2			-2	X	
3	-1			-1		X	
2		+1			+1	X	
1			empty				

Contacts are made in "X" marked position.  
Symbols for interconnection: [

Technical data	Symbol	Merit	Unit
rated operational voltage (DC poles)	Ue	1000	V dc
rated operational current (DC poles)	Ie	16	A dc
rated operational voltage (second rating DC poles, if requested)	Ue	850	V dc
rated operational current (second rating DC poles, if requested)	Ie	20	A dc
rated operational voltage (third rating DC poles, if requested)	Ue	800	V dc
rated operational current (third rating DC poles, if requested)	Ie	25	A dc
rated operational voltage (fourth rating DC poles, if requested)	Ue	650	V dc
rated operational current (fourth rating DC poles, if requested)	Ie	32	A dc
method of mounting	both bottom and single hole mounting [D]		
number of DC poles	10		
utilization category DC			
actuator	standard black [A]		
positions	OFF at 12 hr, ON at 3 hr [E]		
rated impulse withstand voltage	Uimp	8	kV
insulation voltage	Ui	1000	V
rated thermal current uninterrupted duty	Iu	25	A
rated short-time withstand current (1s)	Icw	750	A
rated short-circuit making capacity	Icm	1,4	kA
rated conditional short-circuit current		5	kA
method of operation	independent manual operation		
minimum required dimensions of enclosures L x W x H* (on DIN-rail H = +2mm) (space envelope)	124 x 47 x 147,6 mm		
* see the drawing for the height of the switch. The number of layers N is:	11		
knob operation force	max.	1,4	Nm
tightening torque terminal screws M4, min. - max.	1,5	1,7	Nm
tightening torque panel mounting nut, min. - max.	2,0	2,5	Nm
tightening torque M3 screw in the standard black knob, min. - max.	0,5	0,7	Nm
ambient temperature allowed between	- 40 to + 70 °C		
storage temperature allowed between	- 40 to + 80 °C		
maximum relative humidity, without condensation at 20°C	90 %		
pollution degree	2		
IP rating terminals	IP20		
IP rating gland of the shaft in case of single hole panel mounting	IP65		
rated operational voltage (AC poles)	Ue		V ac
rated operational current (AC poles)	Ie		A ac
number of AC poles (for general use)			
minimum required fine wire cross-section: IEC60947-1, table 9	mm <sup>2</sup>		
auxiliary contact(s), AC15	No auxiliary contact		
auxiliary contact ratings			
weight	453 g		

Data Sheet

Santon X-Type switch XA100.16DL12E-A

Switch disconnecter for solar application according to IEC 60947-1&3 by Dekra (KEMA) and CCC (CQC)



Empty for better insulation  
N = number of contact layer



Terminals Scheme										
Layer No.	Front Side		Symbol	Rear Side		On Positions				
	Left	Right		Left	Right	1	2	3	4	
13	+6			+6		X				
12		-6			-6		X			
11	-5			-5			X			
10		+5			+5		X			
9	+4			+4			X			
8		-4			-4		X			
7	-3			-3			X			
6		+3			+3		X			
5	+2			+2			X			
4		-2			-2		X			
3	-1			-1			X			
2		+1			+1		X			
1	empty									

Contacts are made in "X" marked position.  
Symbols for interconnection: [

Technical data	Symbol	Merit	Unit
rated operational voltage (DC poles)	Ue		1000 V dc
rated operational current (DC poles)	Ie		16 A dc
rated operational voltage (second rating DC poles, if requested)	Ue		850 V dc
rated operational current (second rating DC poles, if requested)	Ie		20 A dc
rated operational voltage (third rating DC poles, if requested)	Ue		800 V dc
rated operational current (third rating DC poles, if requested)	Ie		25 A dc
rated operational voltage (fourth rating DC poles, if requested)	Ue		650 V dc
rated operational current (fourth rating DC poles, if requested)	Ie		32 A dc
method of mounting	both bottom and single hole mounting [D]		
number of DC poles			12
utilization category DC	DC-21B		
actuator	standard black [A]		
positions	OFF at 12 hr, ON at 3 hr [E]		
rated impulse withstand voltage	Uimp		8 kV
insulation voltage	Ui		1000 V
rated thermal current uninterrupted duty	Iu		25 A
rated short-time withstand current (1s)	Icw		750 A
rated short-circuit making capacity	Icm		1,4 kA
rated conditional short-circuit current			5 kA
method of operation	independent manual operation		
minimum required dimensions of enclosures L x W x H* (on DIN-rail H = +2mm)			124 x 47 x 168,6 mm
* see the drawing for the height of the switch. The number of layers N is:			13
knob operation force		max.	1,4 Nm
tightening torque terminal screws M4, min. - max.		1,5	1,7 Nm
tightening torque panel mounting nut, min. - max.		2,0	2,5 Nm
tightening torque M3 screw in the standard black knob, min. - max.		0,5	0,7 Nm
ambient temperature allowed between			- 40 to + 70 °C
storage temperature allowed between			- 40 to + 80 °C
maximum relative humidity, without condensation at 20°C			90 %
pollution degree			2
IP rating terminals			IP20
IP rating gland of the shaft in case of single hole panel mounting			IP65
rated operational voltage (AC poles)	Ue		V ac
rated operational current (AC poles)	Ie		A ac
number of AC poles (for general use)			
minimum required fine wire cross-section: IEC60947-1, table 9			mm <sup>2</sup>
auxiliary contact(s), AC15			No auxiliary contact
auxiliary contact ratings			
weight			522 g
accessories:			



Data Sheet Santon X-Type switch XA100.25DL2E-A

Switch disconnecter for solar application according to IEC 60947-1&3 by Dekra (KEMA)



Empty for better insulation  
N = number of contact layer

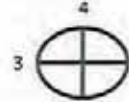

Terminals Scheme					
Layer No.	Front Side Left	Front Side Right	Symbol	Rear Side Left Right	On Positions 1 2 3 4
4			-1	-1	X
3				+1	X
2				+1	X
1			empty		

Contacts are made in "X" marked position.  
Symbols for interconnection: [

Technical data	Symbol	Merit	Unit
rated operational voltage (DC poles)	Ue	1000	V dc
rated operational current (DC poles)	Ie	25	A dc
rated operational voltage (second rating DC poles, if requested)	Ue	0	V dc
rated operational current (second rating DC poles, if requested)	Ie	0	A dc
rated operational voltage (third rating DC poles, if requested)	Ue	0	V dc
rated operational current (third rating DC poles, if requested)	Ie	0	A dc
method of mounting	both bottom and single hole mounting [D] long gland		
number of DC poles	2		
utilization category DC	DC-21B		
actuator	ordered without a knob		
positions	OFF at 9 hr, ON at 12 hr [H]		
rated impulse withstand voltage	Uimp	8	kV
insulation voltage	Ui	1000	V
rated thermal current uninterrupted duty	Iu	25	A
rated short-time withstand current (1s)	Icw	750	A
rated short-circuit making capacity	Icm	1,4	kA
rated conditional short-circuit current		5	kA
resistance per contact		0,5	mΩ
method of operation	independent manual operation		
minimum required dimensions of enclosures L x W x H*			124 x 47 x 74 mm
* see the drawing for the height of the switch. The number of layers N is:			4
Shaft length			mm
Enclosure depth from inside bottom to outside top, required for the switch and knob			107 mm
tightening torque terminal screws M4, min. - max.	1,5	1,7	Nm
tightening torque panel mounting nut, min. - max.	2,0	2,5	Nm
tightening torque M3 screw in the standard black knob, min. - max.	0,5	0,7	Nm
minimum required fine wire cross-section: IEC60947-1, table 9			4 mm2
ambient temperature allowed between			- 20 to + 70 °C
storage temperature allowed between			- 40 to + 80 °C
maximum relative humidity, without condensation at 20°C			90 %
pollution degree			2
IP rating terminals			IP20
IP rating gland of the shaft in case of single hole panel mounting			IP65
rated operational voltage (AC poles)	Ue		V ac
rated operational current (AC poles)	Ie		A ac
number of AC poles			
auxiliary contact(s), AC15			No auxiliary contact
auxiliary contact ratings			
weight			221 g
accessories:			-

Data Sheet

Santon X-Type switch XA100.25DL4E-A

Switch disconnector for solar application according to IEC 60947-1&3 by Dekra (KEMA) and CCC (CQC)



Empty for better insulation  
N = number of contact layer



Terminals Scheme					
Layer No.	Front Side Left	Front Side Right	Rear Side Left	Rear Side Right	On Positions 1 2 3 4
7					
6				+2	X
5	-2			-2	X
4		-1		-1	X
3				+1	X
2				+1	X
1				empty	

Contacts are made in "X" marked position.  
Symbols for interconnection: [

Technical data	Symbol	Merit	Unit
rated operational voltage (DC poles)	Ue	1000	V dc
rated operational current (DC poles)	Ie	25	A dc
rated operational voltage (second rating DC poles, if requested)	Ue	850	V dc
rated operational current (second rating DC poles, if requested)	Ie	20	A dc
rated operational voltage (third rating DC poles, if requested)	Ue	800	V dc
rated operational current (third rating DC poles, if requested)	Ie	25	A dc
rated operational voltage (fourth rating DC poles, if requested)	Ue	650	V dc
rated operational current (fourth rating DC poles, if requested)	Ie	32	A dc
method of mounting		both bottom and single hole mounting [D]	
number of DC poles		4	
utilization category DC			
actuator		standard black [A]	
positions		OFF at 12 hr, ON at 3 hr [E]	
rated impulse withstand voltage	Uimp	8	kV
insulation voltage	Ui	1000	V
rated thermal current uninterrupted duty	Iu	25	A
rated short-time withstand current (1s)	Icw	750	A
rated short-circuit making capacity	Icm	1,4	kA
rated conditional short-circuit current		5	kA
method of operation		independent manual operation	
minimum required dimensions of enclosures L x W x H* (on DIN-rail H = +2mm) (space envelope)		124 x 47 x 105,6	mm
* see the drawing for the height of the switch. The number of layers N is:		7	
knob operation force		max. 1,4	Nm
tightening torque terminal screws M4, min. - max.		1,5 - 1,7	Nm
tightening torque panel mounting nut, min. - max.		2,0 - 2,5	Nm
tightening torque M3 screw in the standard black knob, min. - max.		0,5 - 0,7	Nm
ambient temperature allowed between		-25 to +70	°C
storage temperature allowed between		-40 to +80	°C
maximum relative humidity, without condensation at 20°C		90	%
pollution degree		2	
IP rating terminals		IP20	
IP rating gland of the shaft in case of single hole panel mounting		IP65	
rated operational voltage (AC poles)	Ue		V ac
rated operational current (AC poles)	Ie		A ac
number of AC poles (for general use)			
minimum required fine wire cross-section: IEC60947-1, table 9		mm <sup>2</sup>	
auxiliary contact(s), AC15		No auxiliary contact	
auxiliary contact ratings			
weight		315	g
accessories:			



Data Sheet

XB0310/2

Certified for IEC 60947 1&3  
DC21B and CCC (CQC)

Mentioned rating counts when two poles (+ -) are applied. If there are two negative poles intended to combine in one terminal deck, then the maximal allowable current (A) has to be respected.  
This means the maximal allowable current has to be split by 2 (with 2 poles combined).

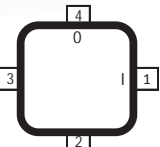
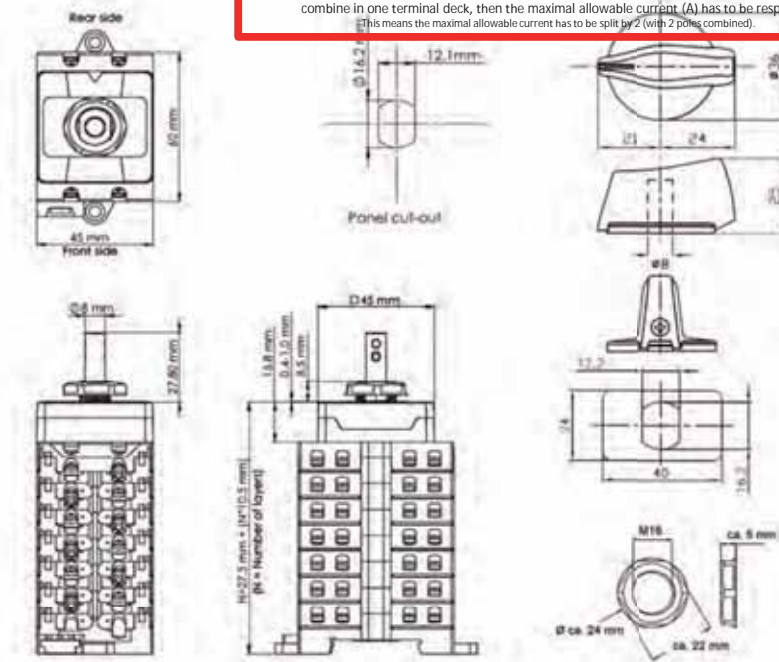

Empty for better insulation  
N = number of contact layer

Technical data	Symbol	Ratings:	I	II	III	IV	V	Unit
Rated operational voltage	Ue		1000	850	800	650	400	V dc
Rated operational current	Ie		16	20	25	30	45	A dc
Required fine wire cross-section (minimal)*:			2,5	4,0	4,0	6,0	10,0	mm <sup>2</sup>
*IEC60947-1, table 9								
Number of DC poles							3	
Utilization category DC							DC-21B	
Pollution degree							2	
IP rating terminals							IP20	
Tightening torque terminal screws M4 (min. - max.)							1,5 - 1,7	Nm
Method of mounting								
IP rating of the shaft in case of single hole and four hole panel mounting							IP65	
Positions								
			12 (OFF)	and 3 o'clock (ON)				
Actuator			Standard A knob with long screw to fix in shaft					
Method of operation			Independent manual operation					
Actuator operation force (max.)							1,4	Nm
Tightening torque M3 screw in the actuator (min. - max.)							0,2 - 0,4	Nm
Rated impulse withstand voltage	Uimp						8	kV
Insulation voltage	Ui						850	V
Rated thermal current uninterrupted duty	Iu						45	A
Rated short-time withstand current (1s)	Icw						700	A
Rated short-circuit making capacity	Icm						1,4	kA
Rated conditional short-circuit current	Isc						5	kA
Minimum required dimensions of enclosures L x W x D* (space envelope)								
			124	x	47	x	60	mm
* see the drawing for the height of the switch. The number of layers N is:								
							3	
Weight							ca. 180	g
Allowed ambient temperature (min. - max.)		T <sub>ambient</sub>					-40 - 70	°C
Allowed storage temperature (min. - max.)		T <sub>storage</sub>					-40 - 85	°C
Relative humidity (max.), without condensation at 20°C		RH					90	%

Terminals Scheme								
Layer No.	Front Side Left	Front Side Right	Rear Side Left	Rear Side Right	Positions 1	2	3	4
7								
6								
5								
4		+2		+2	I			0
3	-			-	I			0
2		+1		+1	I			0
1								

(I = Contact is closed, O = Contact is open)

**Mounting instructions**  
In the application all ratings according to the datasheet have to be respected. After mounting, the wiring must be checked and the switch must operate smoothly. When building the switch in an enclosure, the space envelope must be respected according to the applicable standards.

**Maintenance**  
The X type switches are designed for a very long life but it is advised to do some simple yearly maintenance.  
- Check the installation for signs of overload or overheating. The terminals may not exceed the limit of 85°C under full load.  
- By operating the switch a few times (5x) the contacts will clean themselves and the switch will have a longer life.

**Connection**  
The terminals, can take copper wires up to 6 mm<sup>2</sup>. The recommended Spade Tongue Terminals may have a maximum width of 9 mm (see table for recommendations)

Recommend Manufacturer	Type number	Wire size (AWG)	Wire size (mm <sup>2</sup> )	Color
JST	FVD2-YS4A	AWG 16 - AWG 14	1,0 - 2,5 mm <sup>2</sup>	Blue
TE connectivity	C-165012	AWG 16 - AWG 14	1,0 - 2,5 mm <sup>2</sup>	Blue
Vogt	3635c	AWG 16 - AWG 14	1,5 - 2,5 mm <sup>2</sup>	Blue
TE connectivity	C-165015	AWG 12 - AWG 10	3,0 - 6,0 mm <sup>2</sup>	Yellow
Vogt	3652c / 3653c	AWG 12 - AWG 10	3,0 - 6,0 mm <sup>2</sup>	Yellow
Santon (JST)	52A1256.35	AWG 8 - AWG 10	10,5mm <sup>2</sup> -16mm <sup>2</sup> *1	*2

\*1 16mm<sup>2</sup> only with fine stranded wire (or two times 6mm<sup>2</sup>)  
\*2 Optional: A yellow finger safe sleeve for the Spade Tongue Terminal (Santon 52A1256.35) can be ordered under item number 52A1564.00

Data Sheet

XBE+0210/2

Certified for IEC 60947 1&3  
DC-PV1 and CCC (CQC)

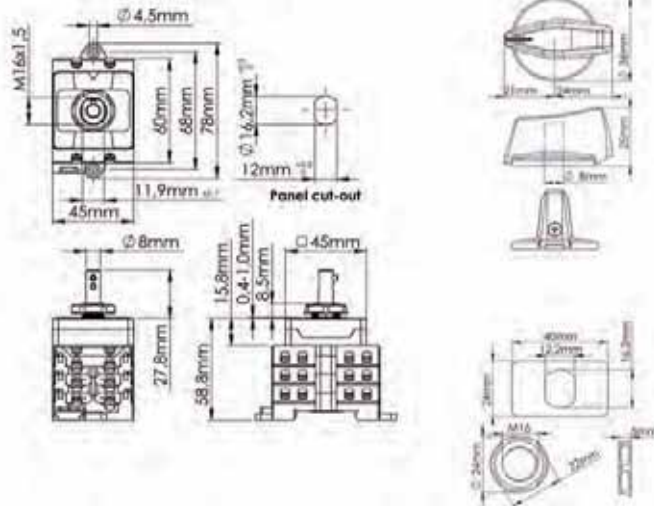

The tolerances for the Santon datasheet are according to ISO 1101, ISO 8015, ISO 2768 1 class m, unless stated otherwise.

Technical data	Symbol	Ratings:	I	II	III	IV	Unit	
Rated operational voltage	Ue		1100	1000	800	500	V dc	
Rated operational current	Ie		10	16	25	50	A dc	
Required fine wire cross-section (minimal)*:			2,5	2,5	4	10	mm <sup>2</sup>	
*IEC60947-1, table 9								
Number of DC poles						2		
Utilization category DC						DC-PV1		
Pollution degree						2		
IP rating terminals						IP20		
Tightening torque terminal screws M4 (min. - max.)					1,5	- 1,7	Nm	
Method of mounting								
IP rating of the shaft in case of single hole mounting						IP65		
Tightening torque panel mounting nut (min. - max.)					2,0	- 2,5	Nm	
Panel thickness between					1	- 4	mm	
Positions						12 (OFF) and 3 o'clock (ON)		
Actuator						Standard A knob with long screw to fix in shaft		
Method of operation						Independent manual operation		
Actuator operation force (max.)						1,4	Nm	
Tightening torque M3 screw in the actuator (min. - max.)					0,50	- 0,70	Nm	
Rated impulse withstand voltage	Uimp					8	kV	
Insulation voltage	Ui					1100	V	
Rated thermal current uninterrupted duty	Iu					50	A	
Rated short-time withstand current (1s)	Icw					700	A	
Rated short-circuit making capacity	Icm					1	kA	
Rated conditional short-circuit current	Isc					5	kA	
Minimum required dimensions of enclosures L x W x D* (space envelope)			124	x	47	x	50	mm
* see the drawing for the height of the switch. The number of layers N is:							2	
Weight							ca. 149	g
Allowed ambient temperature (min. - max.)	Tambient						-40 - 70	°C
Allowed storage temperature (min. - max.)	Tstorage						-40 - 85	°C
Relative humidity (max.), without condensation at 20°C	RH						90	%

Terminals Scheme									
Layer No.	Front Side Left	Right	Symbol	Rear Side Left	Right	Positions 1	2	3	4
9									
8									
7									
6									
5									
4									
3	-1			-1		I			0
2		+1			+1	I			0
1			Empty						

(I = Contact is closed, O = Contact is open)

Mounting instructions

In the application all ratings according to the datasheet have to be respected. After mounting, the wiring must be checked and the switch must operate smoothly. When building the switch in an enclosure, the space envelope must be respected according to the applicable standards.

Maintenance

The X type switches are designed for a very long life but it is advised to do some simple yearly maintenance.  
- Check the installation for signs of overload or overheating. The terminals may not exceed the limit of 85°C under full load.  
- By operating the switch a few times (5x) the contacts will clean themselves and the switch will have a longer life.

Connection

The terminals, can take copper wires up to 6 mm<sup>2</sup>. The recommended Spade Tongue Terminals may have a maximum width of 9 mm (see table for recommendations)

Recommend Manufacturer	Type number	Wire size (AWG)	Wire size (mm <sup>2</sup> )	Color
JST	FVD2-YS4A	AWG 16 - AWG 14	1,0 - 2,5 mm <sup>2</sup>	Blue
TE connectivity	C-165012	AWG 16 - AWG 14	1,0 - 2,5 mm <sup>2</sup>	Blue
Vogt	3635c	AWG 16 - AWG 14	1,5 - 2,5 mm <sup>2</sup>	Blue
TE connectivity	C-165015	AWG 12 - AWG 10	3,0 - 6,0 mm <sup>2</sup>	Yellow
Vogt	3652c / 3653c	AWG 12 - AWG 10	3,0 - 6,0 mm <sup>2</sup>	Yellow
Santon (JST)	52A1256.35	AWG 8 - AWG 10	10,5mm <sup>2</sup> -16mm <sup>2</sup> *1	*2

\*1 16mm<sup>2</sup> only with fine stranded wire (or two times 6mm<sup>2</sup>)  
\*2 Optional: A yellow finger safe sleeve for the Spade Tongue Terminal (Santon 52A1256.35) can be ordered under item number 52A1564.00

Data Sheet

XBE+0410/2

Certified for IEC 60947 1&3  
DC-PV1 and CCC (CQC)

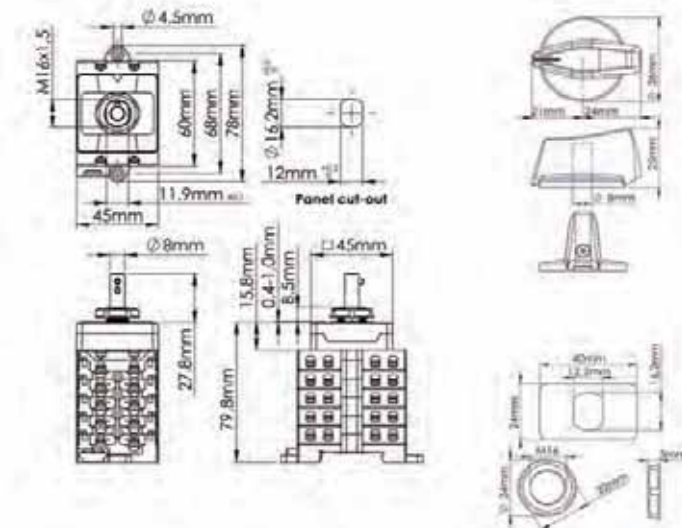

The tolerances for the Santon datasheet are according to ISO 1101, ISO 8015, ISO 2768 1 class m, unless stated otherwise.

Technical data	Symbol	Ratings:	I	II	III	IV	Unit	
Rated operational voltage	Ue		1100	1000	800	500	V dc	
Rated operational current	Ie		10	16	25	50	A dc	
Required fine wire cross-section (minimal)*:			2,5	2,5	4	10	mm <sup>2</sup>	
*IEC60947-1, table 9								
Number of DC poles						4		
Utilization category DC						DC-PV1		
Pollution degree						2		
IP rating terminals						IP20		
Tightening torque terminal screws M4 (min. - max.)					1,5	- 1,7	Nm	
Method of mounting								
IP rating of the shaft in case of single hole mounting						IP65		
Tightening torque panel mounting nut (min. - max.)						2,0 - 2,5	Nm	
Panel thickness between					1	- 4	mm	
Positions			12 (OFF) and 3 o'clock (ON)					
Actuator						Standard A knob with long screw to fix in shaft		
Method of operation						Independent manual operation		
Actuator operation force (max.)						1,4	Nm	
Tightening torque M3 screw in the actuator (min. - max.)					0,50	- 0,70	Nm	
Rated impulse withstand voltage	Uimp					8	kV	
Insulation voltage	Ui					1100	V	
Rated thermal current uninterrupted duty	Iu					50	A	
Rated short-time withstand current (1s)	Icw					700	A	
Rated short-circuit making capacity	Icm					1	kA	
Rated conditional short-circuit current	Isc					5	kA	
Minimum required dimensions of enclosures L x W x D* (space envelope)			124	x	47	x	71	mm
* see the drawing for the height of the switch. The number of layers N is:							4	
Weight						ca. 211	g	
Allowed ambient temperature (min. - max.)	Tambient					-40 - 70	°C	
Allowed storage temperature (min. - max.)	Tstorage					-40 - 85	°C	
Relative humidity (max.), without condensation at 20 °C	RH					90	%	

Terminals Scheme						
Layer No.	Front Side Left	Right	Symbol	Rear Side Left	Right	Positions 1 2 3 4
9						
8						
7						
6						
5	+2			+2	I	0
4		-2			-2	I 0
3		-1			-1	I 0
2		+1			+1	I 0
1			Empty			

(I = Contact is closed, O = Contact is open)

Mounting instructions

In the application all ratings according to the datasheet have to be respected. After mounting, the wiring must be checked and the switch must operate smoothly. When building the switch in an enclosure, the space envelope must be respected according to the applicable standards.

Maintenance

The X type switches are designed for a very long life but it is advised to do some simple yearly maintenance.  
- Check the installation for signs of overload or overheating. The terminals may not exceed the limit of 85°C under full load.  
- By operating the switch a few times (5x) the contacts will clean themselves and the switch will have a longer life.

Connection

The terminals, can take copper wires up to 6 mm<sup>2</sup>. The recommended Spade Tongue Terminals may have a maximum width of 9 mm (see table for recommendations)

\*1 16mm<sup>2</sup> only with fine stranded wire (or two times 6mm<sup>2</sup>)

\*2 Optional: A yellow finger safe sleeve for the Spade Tongue Terminal (Santon 52A1256.35) can be ordered under item number 52A1564.00

Recommend Manufacturer	Type number	Wire size (AWG)	Wire size (mm <sup>2</sup> )	Color
JST	FVD2-Y54A	AWG 16 - AWG 14	1,0 - 2,5 mm <sup>2</sup>	Blue
TE connectivity	C-165012	AWG 16 - AWG 14	1,0 - 2,5 mm <sup>2</sup>	Blue
Vogt	3635c	AWG 16 - AWG 14	1,5 - 2,5 mm <sup>2</sup>	Blue
TE connectivity	C-165015	AWG 12 - AWG 10	3,0 - 6,0 mm <sup>2</sup>	Yellow
Vogt	3652c / 3653c	AWG 12 - AWG 10	3,0 - 6,0 mm <sup>2</sup>	Yellow
Santon (JST)	52A1256.35	AWG 8 - AWG 10	10,5mm <sup>2</sup> -16mm <sup>2</sup> *1	*2

Data Sheet

XBE+0610/2

Certified for IEC 60947 1&3  
DC-PV1 and CCC (CQC)

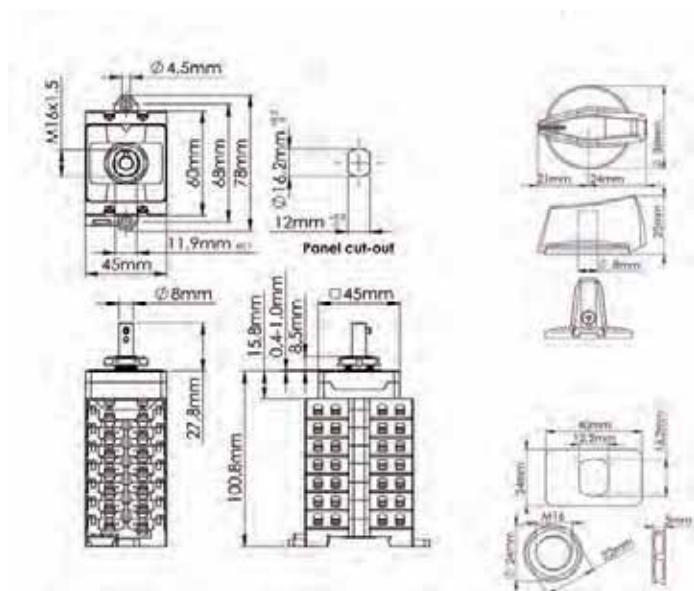

The tolerances for the Santon datasheet are according to ISO 1101, ISO 8015, ISO 2768 1 class m, unless stated otherwise.

Technical data	Symbol	Ratings:	I	II	III	IV	Unit	
Rated operational voltage	Ue		1100	1000	800	500	V dc	
Rated operational current	Ie		10	16	25	50	A dc	
Required fine wire cross-section (minimal)*:			2,5	2,5	4	10	mm <sup>2</sup>	
*IEC60947-1, table 9								
Number of DC poles						6		
Utilization category DC						DC-PV1		
Pollution degree						2		
IP rating terminals						IP20		
Tightening torque terminal screws M4 (min. - max.)					1,5	- 1,7	Nm	
Method of mounting								
IP rating of the shaft in case of single hole mounting						IP65		
Tightening torque panel mounting nut (min. - max.)					2,0	- 2,5	Nm	
Panel thickness between					1	- 4	mm	
Positions			12 (OFF) and 3 o'clock (ON)					
Actuator			Standard A knob with long screw to fix in shaft					
Method of operation			Independent manual operation					
Actuator operation force (max.)						1,4	Nm	
Tightening torque M3 screw in the actuator (min. - max.)					0,50	- 0,70	Nm	
Rated impulse withstand voltage	Uimp					8	kV	
Insulation voltage	Ui					1100	V	
Rated thermal current uninterrupted duty	Iu					50	A	
Rated short-time withstand current (1s)	Icw					700	A	
Rated short-circuit making capacity	Icm					1	kA	
Rated conditional short-circuit current	Isc					5	kA	
Minimum required dimensions of enclosures L x W x D* (space envelope)			124	x	47	x	92	mm
* see the drawing for the height of the switch. The number of layers N is:						6		
Weight						ca. 274	g	
Allowed ambient temperature (min. - max.)	Tambient					-40 - 70	°C	
Allowed storage temperature (min. - max.)	Tstorage					-40 - 85	°C	
Relative humidity (max.), without condensation at 20°C	RH					90	%	

Terminals Scheme									
Layer No.	Front Side Left	Right	Symbol	Rear Side Left	Right	Positions 1	2	3	4
9									
8									
7	-3			-3		I			0
6		+3			+3	I			0
5	+2			+2		I			0
4		-2			-2	I			0
3	-1			-1		I			0
2		+1			+1	I			0
1			Empty						

(I = Contact is closed, O = Contact is open)

Mounting instructions

In the application all ratings according to the datasheet have to be respected. After mounting, the wiring must be checked and the switch must operate smoothly. When building the switch in an enclosure, the space envelope must be respected according to the applicable standards.

Maintenance

The X type switches are designed for a very long life but it is advised to do some simple yearly maintenance.  
- Check the installation for signs of overload or overheating. The terminals may not exceed the limit of 85°C under full load.  
- By operating the switch a few times (5x) the contacts will clean themselves and the switch will have a longer life.

Connection

The terminals, can take copper wires up to 6 mm<sup>2</sup>. The recommended Spade Tongue Terminals may have a maximum width of 9 mm (see table for recommendations)

Recommend Manufacturer	Type number	Wire size (AWG)	Wire size (mm <sup>2</sup> )	Color
IST	FVD2-YS4A	AWG 16 - AWG 14	1,0 - 2,5 mm <sup>2</sup>	Blue
TE connectivity	C-165012	AWG 16 - AWG 14	1,0 - 2,5 mm <sup>2</sup>	Blue
Vogt	3635c	AWG 16 - AWG 14	1,5 - 2,5 mm <sup>2</sup>	Blue
TE connectivity	C-165015	AWG 12 - AWG 10	3,0 - 6,0 mm <sup>2</sup>	Yellow
Vogt	3652c / 3653c	AWG 12 - AWG 10	3,0 - 6,0 mm <sup>2</sup>	Yellow
Santon (JST)	52A1256.35	AWG 8 - AWG 10	10,5mm <sup>2</sup> -16mm <sup>2</sup> *1	*2

\*1 16mm<sup>2</sup> only with fine stranded wire (or two times 6mm<sup>2</sup>)  
\*2 Optional: A yellow finger safe sleeve for the Spade Tongue Terminal (Santon 52A1256.35) can be ordered under item number 52A1564.00



Data Sheet

XBE+0810/2

Certified for IEC 60947 1&3  
DC21B and CCC (CQC)

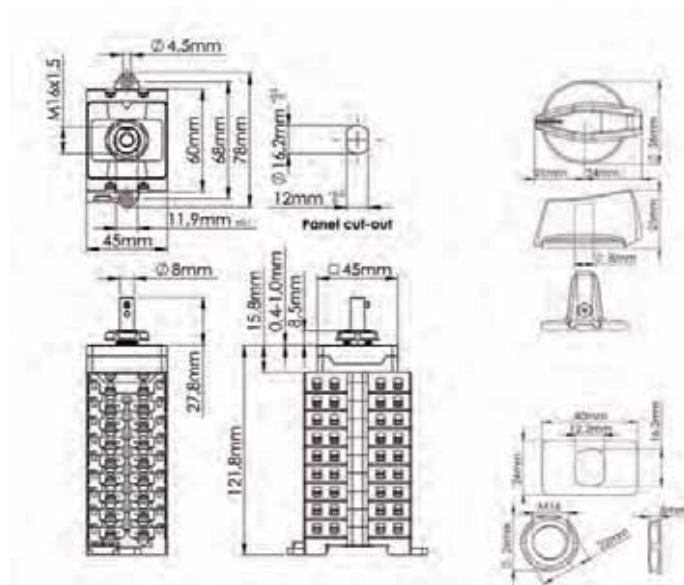

The tolerances for the Santon datasheet are according to ISO 1101, ISO 8015, ISO 2768 1 class m, unless stated otherwise.

Technical data	Symbol	Ratings:	I	II	III	IV	Unit	
Rated operational voltage	Ue		1100	1000	800	500	V dc	
Rated operational current	Ie		10	16	25	50	A dc	
Required fine wire cross-section (minimal)*:			2,5	2,5	4	10	mm <sup>2</sup>	
* IEC60947-1, table 9								
Number of DC poles						8		
Utilization category DC						DC-PV1		
Pollution degree						2		
IP rating terminals						IP20		
Tightening torque terminal screws M4 (min. - max.)				1,5	-	1,7	Nm	
Method of mounting								
IP rating of the shaft in case of single hole mounting						IP65		
Tightening torque panel mounting nut (min. - max.)				2,0	-	2,5	Nm	
Panel thickness between				1	-	4	mm	
Positions			12 (OFF) and 3 o'clock (ON)					
Actuator			Standard A knob with long screw to fix in shaft					
Method of operation								
Actuator operation force (max.)						1,4	Nm	
Tightening torque M3 screw in the actuator (min. - max.)				0,50	-	0,70	Nm	
Rated impulse withstand voltage	Uimp					8	kV	
Insulation voltage	Ui					1100	V	
Rated thermal current uninterrupted duty	Iu					50	A	
Rated short-time withstand current (1s)	Icw					700	A	
Rated short-circuit making capacity	Icm					1	kA	
Rated conditional short-circuit current	Isc					5	kA	
Minimum required dimensions of enclosures L x W x D* {space envelope}								
			124	x	47	x	92	mm
* see the drawing for the height of the switch. The number of layers N is:								
						6		
Weight								
						ca. 274	g	
Allowed ambient temperature (min. - max.)	Tambient			-40	-	70	°C	
Allowed storage temperature (min. - max.)	Tstorage			-40	-	85	°C	
Relative humidity (max.), without condensation at 20°C	RH					90	%	

Terminals Scheme								
Layer No.	Front Side	Symbol	Rear Side	Positions	1	2	3	4
	Left	Right	Left	Right				
9	+4		+4		I			0
8		-4		-4	I			0
7	-3		-3		I			0
6		+3		+3	I			0
5	+2		+2		I			0
4		-2		-2	I			0
3	-1		-1		I			0
2		+1		+1	I			0
1			Empty					

(I = Contact is closed, 0 = Contact is open)

Mounting instructions

In the application all ratings according to the datasheet have to be respected. After mounting, the wiring must be checked and the switch must operate smoothly. When building the switch in an enclosure, the space envelope must be respected according to the applicable standards.

Maintenance

The X type switches are designed for a very long life but it is advised to do some simple yearly maintenance.  
- Check the installation for signs of overload or overheating. The terminals may not exceed the limit of 85°C under full load.  
- By operating the switch a few times (5x) the contacts will clean themselves and the switch will have a longer life.

Connection

The terminals, can take copper wires up to 6 mm<sup>2</sup>. The recommended Spade Tongue Terminals may have a maximum width of 9 mm (see table for recommendations)

\*1 16mm<sup>2</sup> only with fine stranded wire (or two times 6mm<sup>2</sup>)

\*2 Optional: A yellow finger safe sleeve for the Spade Tongue Terminal (Santon 52A1256.35) can be ordered under item number 52A1564.00

Recommend Manufacturer	Type number	Wire size (AWG)	Wire size (mm <sup>2</sup> )	Color
JST	FVD2-YS4A	AWG 16 – AWG 14	1,0 – 2,5 mm <sup>2</sup>	Blue
TE connectivity	C-165012	AWG 16 – AWG 14	1,0 – 2,5 mm <sup>2</sup>	Blue
Vogt	3635c	AWG 16 – AWG 14	1,5 – 2,5 mm <sup>2</sup>	Blue
TE connectivity	C-165015	AWG 12 – AWG 10	3,0 – 6,0 mm <sup>2</sup>	Yellow
Vogt	3652c / 3653c	AWG 12 – AWG 10	3,0 – 6,0 mm <sup>2</sup>	Yellow
Santon (JST)	52A1256.35	AWG 8 – AWG 10	10,5mm <sup>2</sup> -16mm <sup>2</sup> *1	*2

**Data Sheet** XBHP+0210/2 , XBHP+0410/2



Terminals Scheme									
Layer No.	Front Side		Symbol	Rear Side		Positions			
	Left	Right		Left	Right	1	2	3	4
9									
8									
7									
6									
5									
4									
3	-1			-1		I			0
2		+1			+1	I			0
1			Empty						

Terminals Scheme									
Layer No.	Front Side		Symbol	Rear Side		Positions			
	Left	Right		Left	Right	1	2	3	4
9									
8									
7									
6									
5	+2			+2		I			0
4		-2			-2	I			0
3	-1			-1		I			0
2		+1			+1	I			0
1			Empty						

(I = Contact is closed, O = Contact is open)

Technical data	Symbol	Ratings:	I	II	III	IV	Unit	
Rated operational voltage	Ue		1200	1000	800	600	V dc	
Rated operational current	Ie		20	30	40	50	A dc	
Required fine wire cross-section (minimal)*:			4	6	10	10	mm <sup>2</sup>	
*IEC60947-1, table 9								
Number of DC poles						2		
Utilization category DC						DC-PV1		
Pollution degree						2		
IP rating terminals						IP20		
Tightening torque terminal screws M4 (min. - max.)					1,5	- 1,7	Nm	
Method of mounting								
IP rating of the shaft in case of single hole mounting						IP65		
Tightening torque panel mounting nut (min. - max.)					2,0	- 2,5	Nm	
Panel thickness between					1	- 4	mm	
Positions			12 (OFF) and 3 o'clock (ON)					
Actuator			Standard A knob with long screw to fix in shaft					
Method of operation			Independent manual operation					
Actuator operation force (max.)						1,4	Nm	
Tightening torque M3 screw in the actuator (min. - max.)					0,50	- 0,70	Nm	
Rated impulse withstand voltage	Uimp					8	kV	
Insulation voltage	Ui					1200	V	
Rated thermal current uninterrupted duty	Iu					50	A	
Rated short-time withstand current (1s)	Icw					700	A	
Rated short-circuit making capacity	Icm					1	kA	
Rated conditional short-circuit current	Isc					5	kA	
Minimum required dimensions of enclosures L x W x D* {space envelope}								
			124	x	47	x	50	mm
* see the drawing for the height of the switch. The number of layers N is:								
						2		
Weight						ca. 149	g	
Allowed ambient temperature (min. - max.)	Tambient				-40	- 70	°C	
Allowed storage temperature (min. - max.)	Tstorage				-40	- 85	°C	
Relative humidity (max.), without condensation at 20°C	RH					90	%	



Data Sheet

XC150.20DL2E-A / XC150.20DL4E-A / XC150.20DL6E-A / XC150.20DL8E-A

Switch disconnecter for solar application according to IEC 60947-1&3 by Dekra (KEMA) and CCC (CQC)

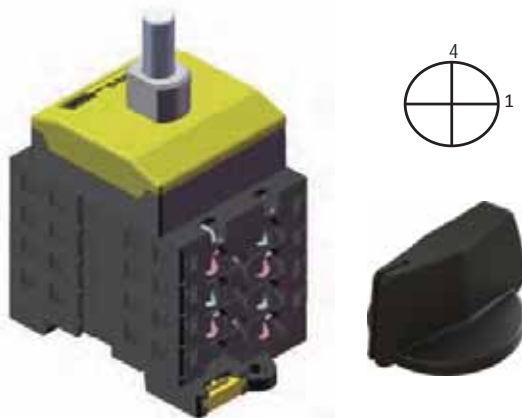

Contacts are made in "X" marked position. Symbols for interconnection: [

XC150.20DL2E-A					XC150.20DL4E-A						
Layer No.	Front Side		Rear Side		On Positions	Layer No.	Front Side		Rear Side		On Positions
	Left	Right	Left	Right			Left	Right	Left	Right	
3	-1		-1		X	5	+2		+2		X
2		+1		+1	X	4	-2		-2		X
1						3	-1		-1		X
						2		+1		+1	X
						1					

  

XC150.20DL6E-A					XC150.20DL8E-A						
Layer No.	Front Side		Rear Side		On Positions	Layer No.	Front Side		Rear Side		On Positions
	Left	Right	Left	Right			Left	Right	Left	Right	
7	-3		-3		X	9	+4		+4		X
6		+3		+3	X	8	-4		-4		X
5	+2		+2		X	7	-3		-3		X
4		-2		-2	X	6	+3		+3		X
3	-1		-1		X	5	+2		+2		X
2		+1		+1	X	4	-2		-2		X
1						3	-1		-1		X
						2		+1		+1	X
						1					

Technical data	Symbol	Merit	Unit
rated operational voltage (DC poles)	Ue		1500 V dc
rated operational current (DC poles)	Ie		20 A dc
rated operational voltage (second rating DC poles, if requested)	Ue		1000 V dc
rated operational current (second rating DC poles, if requested)	Ie		50 A dc
method of mounting			both bottom and single hole mounting [D]
number of DC poles			6
utilization category DC			DC-21B
actuator			standard black [A]
positions			OFF at 12 hr, ON at 3 hr [E]
rated impulse withstand voltage	Uimp		8 kV
insulation voltage	Ui		1500 V
rated thermal current uninterrupted duty	Iu		50 A
rated short-time withstand current (1s)	Icw		750 A
rated short-circuit making capacity	Icm		1,4 kA
rated conditional short-circuit current			5 kA
method of operation			independent manual operation
minimum required dimensions of enclosures L x W x H* (on DIN-rail H = +2mm) {space envelope}			124 x 47 x 84,6 mm
* see the drawing for the height of the switch. The number of layers N is:			5
knob operation force		max.	1,4 Nm
tightening torque terminal screws M4, min. - max.		1,5	1,7 Nm
tightening torque panel mounting nut, min. - max.		2,0	2,5 Nm
tightening torque M3 screw in the standard black knob, min. - max.		0,5	0,7 Nm
ambient temperature allowed between			- 40 to + 80 °C
storage temperature allowed between			- 40 to + 80 °C
maximum relative humidity, without condensation at 20°C			90 %
pollution degree			2
IP rating terminals			IP20
IP rating gland of the shaft in case of single hole panel mounting			IP65
rated operational voltage (AC poles)	Ue		V ac
rated operational current (AC poles)	Ie		A ac
number of AC poles (for general use)			
minimum required fine wire cross-section: IEC60947-1, table 9			mm <sup>2</sup>
auxiliary contact(s), AC15			No auxiliary contact
auxiliary contact ratings			
weight			254 g
accessories:	-		
	-		

Data Sheet

XC+150.20DL2E-D / XC+150.20DL4E-D / XC+150.20DL6E-D / XC+150.20DL8E-D

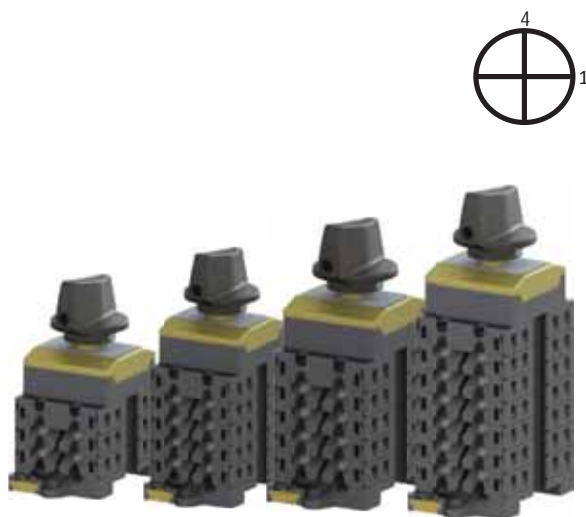

XC+150.20DL2E-D						XC+150.20DL4E-D							
Layer No.	Front Side		Symbol	Rear Side		On Positions	Layer No.	Front Side		Symbol	Rear Side		On Positions
	Left	Right		Left	Right			Left	Right		Left	Right	
3	-1			-1		X	5	+2			+2		X
2		+1			+1	X	4		-2		-2		X
1			empty				3	-1			-1		X
							2		+1		+1		X
							1			empty			

XC+150.20DL6E-D						XC+150.20DL8E-D							
Layer No.	Front Side		Symbol	Rear Side		On Positions	Layer No.	Front Side		Symbol	Rear Side		On Positions
	Left	Right		Left	Right			Left	Right		Left	Right	
7	-3			-3		X	9	+4			+4		X
6		+3			+3	X	8		-4		-4		X
5	+2			+2		X	7	-3			-3		X
4		-2			-2	X	6		+3		+3		X
3	-1			-1		X	5	+2			+2		X
2		+1			+1	X	4		-2		-2		X
1			empty				3	-1			-1		X
							2		+1		+1		X
							1			empty			

Technical data	Symbol	Merit	Unit
rated operational voltage (DC poles)	Ue		1500 V dc
rated operational current (DC poles)	Ie		20 A dc
rated operational voltage (DC poles)	Ue		1000 V dc
rated operational current (DC poles)	Ie		50 A dc
rated operational voltage (DC poles)	Ue		800 V dc
rated operational current (DC poles)	Ie		60 A dc
method of mounting	both bottom and single hole mounting [D]		
number of DC poles	2		
utilization category DC	DC-PV1		
actuator	standard black, with thread through the shaft [D]		
positions	OFF at 12 hr, ON at 3 hr [E]		
rated impulse withstand voltage	Uimp		8 kV
insulation voltage	Ui		1500 V
rated thermal current uninterrupted duty	Iu		60 A
rated short-time withstand current (1s)	Icw		750 A
rated short-circuit making capacity	Icm		1,4 kA
rated conditional short-circuit current			5 kA
method of operation	independent manual operation		
minimum required dimensions of enclosures L x W x H* (on DIN-rail H = +2mm) (space envelope)	124 x 47 x 63,6 mm		
* see the drawing for the height of the switch. The number of layers N is:	3		
knob operation force		max.	1,4 Nm
tightening torque terminal screws M4, min. - max.		1,5	1,7 Nm
tightening torque panel mounting nut, min. - max.		2,0	2,5 Nm
tightening torque M3 screw in the standard black knob, min. - max.		0,5	0,7 Nm
ambient temperature allowed between	- 40 to + 70 °C		
storage temperature allowed between	- 40 to + 80 °C		
maximum relative humidity, without condensation at 20 °C	90 %		
pollution degree	2		
IP rating terminals	IP20		
IP rating gland of the shaft in case of single hole panel mounting	IP65		
rated operational voltage (AC poles)	Ue		V ac
rated operational current (AC poles)	Ie		A ac
number of AC poles (for general use)			
minimum required fine wire cross-section: IEC60947-1, table 9	mm2		
auxiliary contact(s), AC15	No auxiliary contact		
auxiliary contact ratings			
weight			194 g
accessories:	-		-

**Model S5000 1000V DC21B**

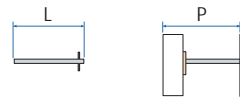

S5000 DC 1000 V				開關 O-I On-Off switch	直接手柄 Direct handle	外部手柄 External handle	軸外伸部 Shaft extensions								
				4P <sup>*)1</sup>	藍色/Blue	藍色/Blue	型號 1/Type 1			型號 2/Type 2					
Ue (Vdc)	安培 Amps	規格 Size	連接 Connection	型號 Code	型號 Code	型號 Code	L (mm)	P (mm)	型號 Code	L (mm)	P (mm)	型號 Code	L (mm)	P (mm)	
900	DC21B	40	0		S5-01604PB0	DS-SI01	DS-SA01	177	85... 195,5	DS-EP04	250	90... 263	DS-EP05	347	90... 400
		40	0		S5-01604PS0	DS-SI01	DS-SA01	177	85... 195,5	DS-EP04	250	90... 263	DS-EP05	347	90... 400
		100	1		S5-01254PR0	DS-SI11	DS-SA11	227	103... 256	DS-EP14	376	108... 400	DS-EP15	536	108... 560
		160	1		S5-02004PR0	DS-SI11	DS-SA11	227	103... 256	DS-EP14	376	108... 400	DS-EP15	536	108... 560
		250	1		S5-03154PR0	DS-SI11	DS-SA11	227	103... 256	DS-EP14	376	108... 400	DS-EP15	536	108... 560
1000	DC21B	400	1		S5-04004PC0	DS-SI11	DS-SA11	227	103... 256	DS-EP14	376	108... 400	DS-EP15	536	108... 560
		500	2		S5-06304PR0	DS-LI21	DS-LA21	195	134... 240	DS-EP24	345	139... 400	DS-EP24	535	139... 560
		630	2		S5-08004PC0	DS-LI21	DS-LA21	195	134... 240	DS-EP24	345	139... 400	DS-EP24	535	139... 560
		850	3		S5-12504PC0	DS-LI31	DS-LA31	186	145... 242	DS-EP32	336	150... 400	DS-EP24	535	150... 600
		1250	4		S5-18004PS0	DS-LI41	DS-LA41	239	235... 400	DS-EP44	204	240... 440	DS-EP45	635	240... 836

<sup>\*)1</sup> 4級同時斷開。

<sup>\*)1</sup> 4 poles simultaneous breaking.

**S5000 DC 4P**

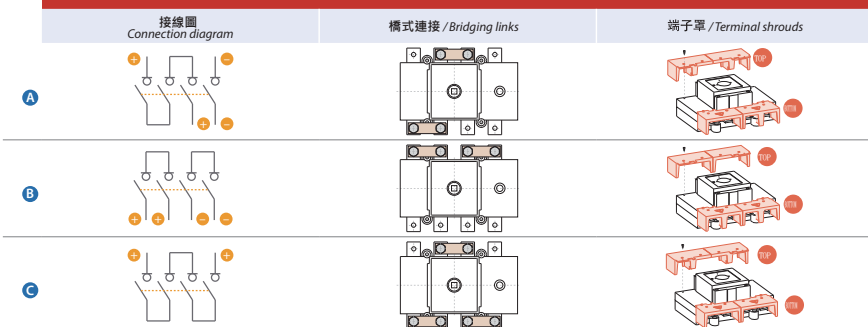

橋式鍵與  
端子罩  
Bridging links & terminal shrouds

接線圖  
Connection diagram

如左



**S5000 DC 8P (多極)**

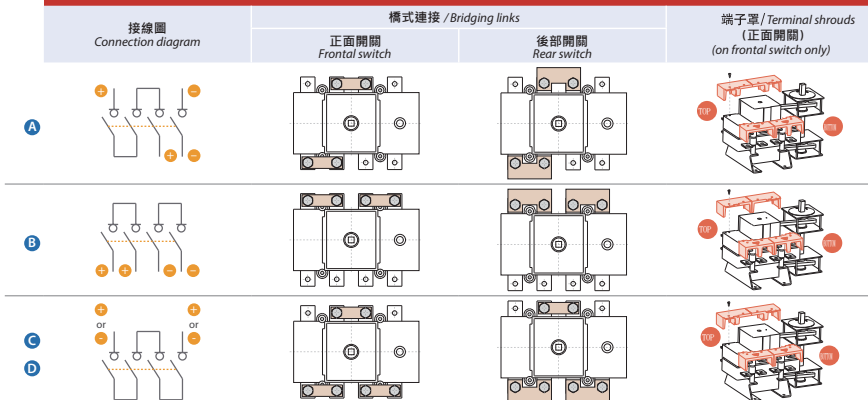

**S5000 DC 3P + 3P**

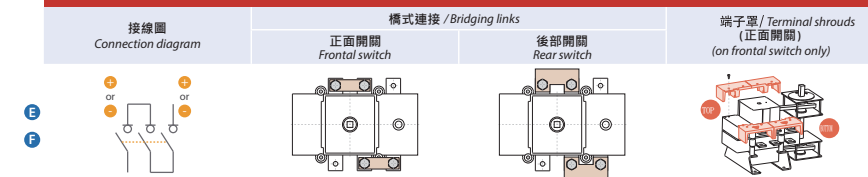

**S5000 DC 4P + 4P**

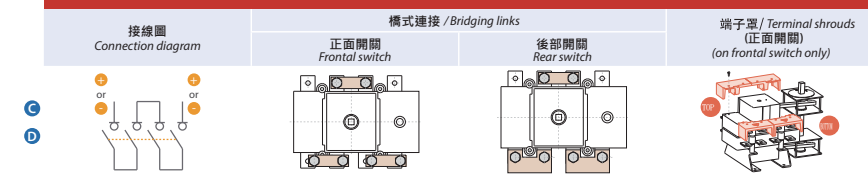

Model S5000 1000V DC21B 接線圖

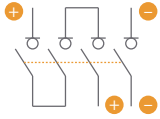
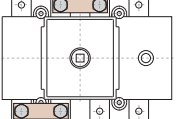
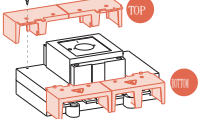
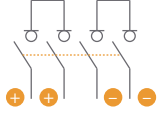
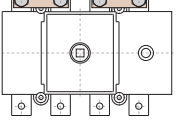
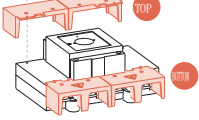
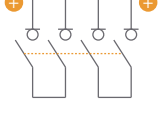
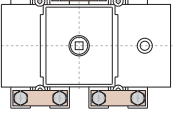
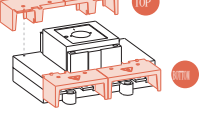
S5000 DC 4P		
接線圖 Connection diagram	橋式連接 / Bridging links	端子罩 / Terminal shrouds
A 		
B 		
C 		

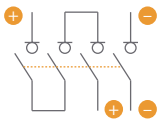
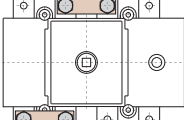
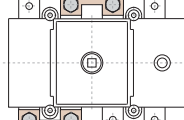
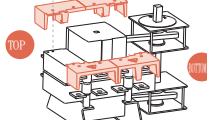
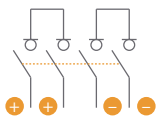
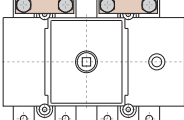
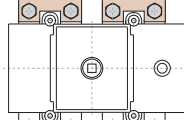
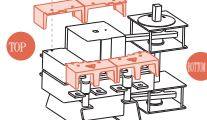
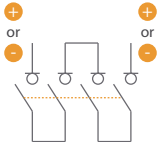
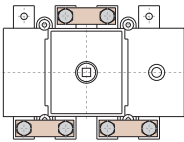
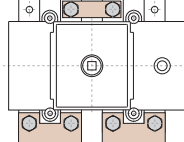
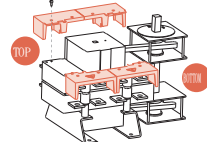
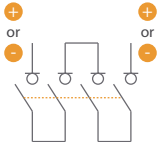
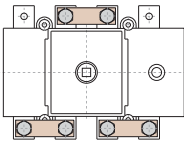
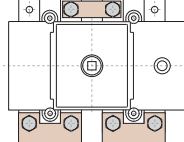
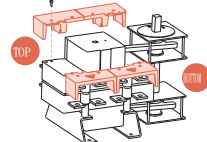
S5000 DC 8P (多極)			
接線圖 Connection diagram	橋式連接 / Bridging links		端子罩 / Terminal shrouds (正面開關) (on frontal switch only)
	正面開關 Frontal switch	後部開關 Rear switch	
A 			
B 			
C 			
D 			

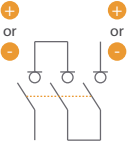
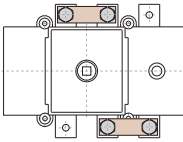
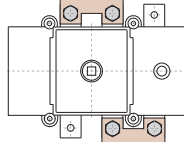
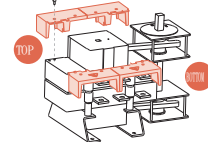
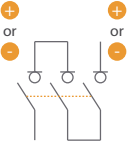
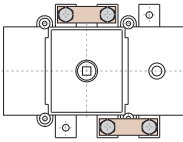
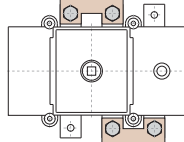
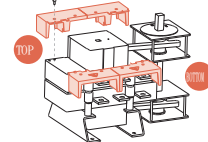
S5000 DC 3P + 3P			
接線圖 Connection diagram	橋式連接 / Bridging links		端子罩 / Terminal shrouds (正面開關) (on frontal switch only)
	正面開關 Frontal switch	後部開關 Rear switch	
E 			
F 			

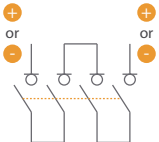
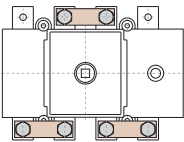
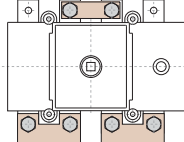
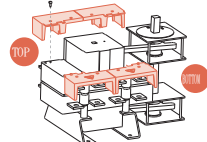
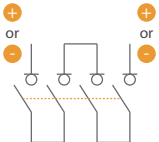
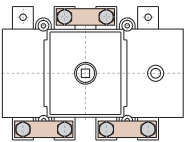
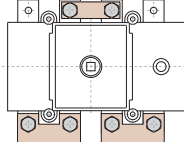
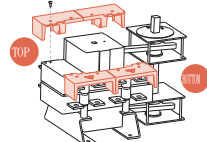
S5000 DC 4P + 4P			
接線圖 Connection diagram	橋式連接 / Bridging links		端子罩 / Terminal shrouds (正面開關) (on frontal switch only)
	正面開關 Frontal switch	後部開關 Rear switch	
C 			
D 			



Model S5000 1000V DC21B 配件



ETL產品型號+OU  
ETL product code  
adding 0U:  
DS-CU\_\_0U

	防護板 Shield protection	接線端護板(兩片) / Terminal shrouds (2 pieces) *									
		規格 0 / Size 0		規格 1 / Size 1 *		規格 2 / Size 2		規格 3 / Size 3		規格 4 / Size 4	
		接線圖 Diagram		接線圖 Diagram		接線圖 Diagram		接線圖 Diagram		接線圖 Diagram	
		A - B	A	B	A	B	A	B	A	B	
IEC產品型號 IEC product code	TOP	DS-CU01	DS-CU18	DS-CU10	DS-CU28	DS-CU20	DS-CU38	DS-CU30	DS-CU48	DS-CU40	
	BOTTOM	DS-CU01	DS-CU19	DS-CU11	DS-CU29	DS-CU21	DS-CU39	DS-CU31	DS-CU49	DS-CU41	
		C - D	C - D		C - D		C - D		C - D		
IEC產品型號 IEC product code	TOP	DS-CU01	DS-CU18		DS-CU28		DS-CU38		DS-CU48		
	BOTTOM	DS-CU01	DS-CU10		DS-CU20		DS-CU30		DS-CU40		
		E - F	E - F		E - F		E - F		E - F		
IEC產品型號 IEC product code	TOP	-	DS-CU18		DS-CU28		DS-CU38		DS-CU48		
	BOTTOM	-	DS-CU10		DS-CU20		DS-CU30		DS-CU40		

\*3P+3P, 4P+4P, 8P的端子罩僅適用於正面安裝的負荷開關 \* For the switches 3P+3P, 4P+4P & 8P the shrouds can only be fitted in the frontal switch.

\*1) 連接請洽詢

\*1) Please consult for connection.



	型號 Code	橋式連接(兩片) / Bridging links (2 pieces)						
		規格 / Size 0		規格 / Size 1		規格 / Size 2	規格 / Size 3	規格 / Size 4
		接線圖 Diagram	接線圖 Diagram	接線圖 Diagram	接線圖 Diagram	接線圖 Diagram	接線圖 Diagram	接線圖 Diagram
		A - B	A - B	A - B	A - B	A - B	A - B	A - B
S5000 DC 4P	DS-PI05	DS-PI01	DS-PI11	DS-PI14	DS-PI21	DS-PI31	DS-PI41	



	型號 Code	橋式連接(兩片或三片) / Bridging links (2/3 pieces)							
		規格 / Size 1		規格 / Size 2		規格 / Size 3		規格 / Size 4	
		接線圖 / Diagram		接線圖 / Diagram		接線圖 / Diagram		接線圖 / Diagram	
		A - B	C	A - B	B	A - B	B	A - B	B
S5000 DC 4P UL CSA	DS-PI120U	DS-PI130U	DS-PI220U	DS-PI230U	DS-PI320U	DS-PI330U	DS-PI420U	DS-PI430U	
		A - B	C - D	A - B	C - D	A - B	C - D	A - B	C - D
S5000 DC 8P (multi-string)	DS-PI120U	DS-PI130U	DS-PI220U	DS-PI230U	DS-PI320U	DS-PI330U	DS-PI420U	DS-PI430U	
	DS-PI170U	DS-PI160U	DS-PI270U	DS-PI260U	DS-PI370U	DS-PI360U	DS-PI470U	DS-PI460U	
		E - F		E - F		E - F		E - F	
S5000 DC 3P+3P	DS-PI120U	洽詢 Consult	DS-PI220U		DS-PI320U		DS-PI420U		
	DS-PI170U	洽詢 Consult	DS-PI270U		DS-PI370U		DS-PI470U		
		C - D		C - D		C - D		C - D	
S5000 DC 4P+4P	DS-PI130U	洽詢 Consult	DS-PI230U		DS-PI330U		DS-PI430U		
	DS-PI160U	洽詢 Consult	DS-PI260U		DS-PI360U		DS-PI460U		

## GM5-PT系列光伏專用直流開關-電氣技術參數

### 性能參數表



GM5-250 PT



GGM5-1250 PT

型號	GM5-250 PT	GM5-1250 PT
殼架等級額定電流Inm	250	1250
額定電流範圍In (A)	63、80、100、125、140、160、180、200、225、250	800,1000,1250 (均可調)
接線方式	2進2出	
額定工作電壓Ue (V) DC	1000	1000
額定絕緣電壓Ui (V)	1000	1000
額定衝擊耐受電壓Uimp (kV)	8	8
極限短路分斷能力 (kA) Icu (Ics=75%Icu)	20	20
機械壽命	總次數	7000
電氣壽命	總次數	2000
總分斷時間 (ms)	20	20
基準環境溫度 (°C)	50	50
是否具有隔離特性	是	是
標準	IEC 60947-2、GB 14048.2 或UL 489B	IEC 60947-2、GB 14048.2或UL 489B
允許環境溫度/°C	-45 ~ +70	-45 ~ +70
防護等級	IP30	IP30
品質認證	CCC、TUV、CE、CB證書	CCC、TUV、CE、CB證書
可帶附件	分勵、輔助、報警	分勵、輔助、報警
飛弧距離 (mm)	≥ 50	≥ 100
瞬時動作值	6In	6In-10In(可調)
外形尺寸	L × W × H	200x90x86
		406x210x140

- MCCB is suitable for DC application such as Photovoltaic Circuit Breaker, UPS and datacenter
- DC short circuit test tested by VDE
- Higher nominal voltage range up to 1000 VDC
- Rated Current : 16A~800A
- No of Pole: 2/3/4Pole
- Available for AC/DC application



	TD100	TD160	TS100	TS160	TS250	TS400	TS630	TS800
Frame size (AF)	100	160	100	160	250	400	630	800
Rated current, In (A)	16, 20, 25, 32, 40, 50, 63, 80, 100	100, 125, 160	40, 50, 63, 80, 100	100, 125, 160	125, 160, 200, 250	300, 400	500, 630	700, 800
No. of Poles (Pole)	2, 3, 4	2, 3, 4	2, 3, 4	2, 3, 4	2, 3, 4	2, 3, 4	2, 3, 4	2, 3, 4
Rating (DC)	1000V	4P	4P	4P	4P	4P	4P	4P
	750V	3P 3P		3P	3P	3P	3P	3P
	500V	2P	2P	2P	2P	2P	2P	2P
Rated service breaking (DC)	Type	N H L N H L	N H L N H L	N H L N H L	N H L N H L	N H L N H L	N H L N H L	N H L N H L
	1000V (4P)	42 65 100 42 65 100	50 85 100 50 85 100	50 85 100 50 85 100	50 85 100 50 85 100	50 85 100 50 85 100	50 85 100 50 85 100	50 85 100 50 85 100
	750V (3P)	42 65 100 42 65 100	50 85 100 50 85 100	50 85 100 50 85 100	50 85 100 50 85 100	50 85 100 50 85 100	50 85 100 50 85 100	50 85 100 50 85 100
500V (2P)	42 65 100 42 65 100	50 85 100 50 85 100	50 85 100 50 85 100	50 85 100 50 85 100	50 85 100 50 85 100	50 85 100 50 85 100	50 85 100 50 85 100	
Trip unit								
	FTU (fixed-thermal, fixed-magnetic)	●	●	●	●	●	●	●
	FMU (adjustable-thermal, fixed-magnetic)	●	●	●	●	●	●	●
ATU (adjustable-thermal, adjustable-magnetic)	--	-	-	-	--	-	●	●

**Exemplary circuit diagrams**

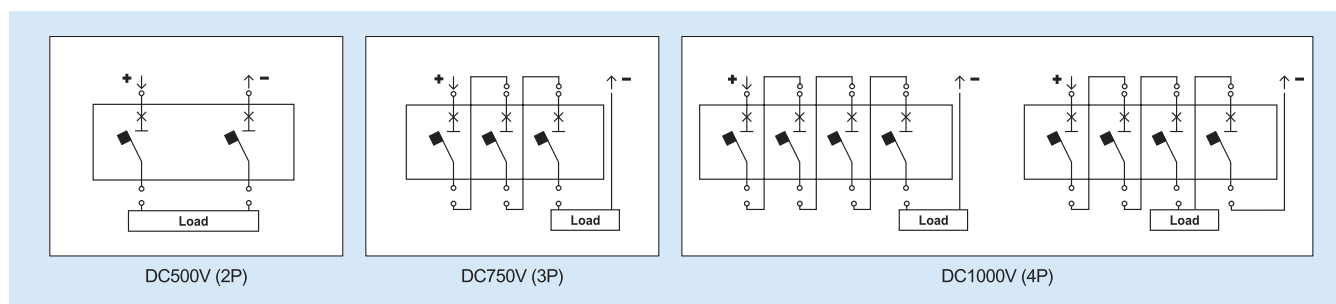

## Derating Table for AF

The following tables are based on the following assumptions;

- Maximum permissible temperature of busbars are 100
- T : Temperature around the circuit breaker and its connections

Note) 1. The values presented in the tables are the result of trials and theoretical calculations on the basis of the assumption mentioned above.  
2. These tables are intended as an aid in designing connection, however, the actual values must be confirmed by tests on the installation.

AF	Rated current(A)	Derating(A)	Short Busbar
TD100	16	16	TD160 3t Short Busbar
	20	20	
	25	25	
	32	32	
	40	40	
	50	50	
	63	63	
	80	80	
TD160	100	100	TD160 4t Short Busbar
	125	125	
	160	135	
TS100	40	40	TS250 4t Short Busbar
	50	50	
	63	63	
	80	80	
	100	100	
TS160	100	100	TS250 5t Short Busbar
	125	125	
	160	135	
TS250	125	125	TS800 Lower & Upper Short Busbar
	160	160	
	200	180	
	250	180	
TS400	300	300	TS800 Lower & Upper Short Busbar
	400	400	
TS630	500	500	
	630	500	
TS800	700 *	700	
	800	700	

Note) 1. \* Only available for TS800FTU  
2. Dimension on the short busbar refer to A-6-47-52.  
3. Short busbar for PV application is not provided by LSIS.

Trip unit identification







### VIM-M master unit RS 485資料傳輸單元

Master communication capability. RS485 communication port (Modbus). Local communication bus management up to 15 mixed VIM-S, VIM-P and VIM-O unit. Two digital inputs. Two temperature inputs: PT100 or PT1000. Single virtual or real alarm set-point connectable to any available variable. Data and event stamping system Display readout: 6 DGTs. 12 to 28 VDC power supply. IP40, DIN module.

RS485資料傳輸單元：可接15個介面，2個數位輸入，2個溫測輸入Pt100 or 1000，-50~+200°C，3 wire，0.1°C/0.1°F，±0.5%RDG，六位數顯示個別單串之電流、電壓、功率，加總由RS485輸出，RS485 multi-drop雙向，2 wire 1000M，247位置選擇，自動位址，擷取VIM-S, VIM-P, VIM-O 訊息如：防盜、保險絲熔斷、PV接線問題，PV逆向電壓暨極性、電流、電壓、功率、日照、風速、開關或避雷狀態、自動清洗或遙控，IP40 DIN rail mount。



### VIM-S string unit 1000Vdc 串列量測單元

Direct DC voltage measurement up to 1000V, Energy measurements : kWh. Direct DC current measurement up to 16A or up to 30A without fuse. Instantaneous variables data format : 4 DGTs. Energies data format : 6 DGT Instantaneous variables : V, A, W. Accuracy : Class 1 (kWh) ±0.5 RDG (current/voltage) Auxiliary power supply from VIM-M unit String alarm management by means of VIM-M unit only. Fuse blow detection by means of VIM-M unit only. PV module connection control by means of VIM-M unit only. Integrated 10.3x38mm fuse holder for string protection. IP40, DIN module.

串列即時量測單元：KWH, V, A, W 保險絲熔斷、PV接線問題，PV逆向電壓暨極性，電壓等級DC1000V，直測DC直流16A或30A，Continuous overload 1100 Vdc, for 500ms 1600Vdc, to earth 800Vdc, 內置10.3\*38mm fuse座，IEC60269-1，不含fuse，IP40 DIN rail mount。



### VIM-P measuring unit 溫度、日照、風速量測單元

Measurements : PV module temperature, air temperature, sun irradiation, wind speed. Two temperature inputs : Pt100 or Pt1000. One 120mV or 20mA DC input with scaling capability for irradiation measurement. One pulse input for wind speed measurement. Auxiliary communication bus to VIM-M unit. Auxiliary power supply from VIM-M unit. IP40, DIN module.

溫度、日照、風速量測單元：溫度 one module Temp. input, one air Temp. input, Pt 100 or 1000, -50~+200°C，3 wire，0.1°C/0.1°F，±0.5%RDG，日照一個輸入，解析1W/M<sup>2</sup>，0~120mvVDC±0.2%，風速一個輸入，誤差±0.02%，0-1000HZ，IP40 DIN rail mount。



### VIM-O input / output unit 輸出入單元

Expansion I/O module (digital inputs and outputs). Two relay outputs managed by the VIM-M module. Two digital inputs managed by the VIM-M module. Auxiliary power supply from VIM-M module. IP40, DIN module.

輸出入單元：由VIM-M主控二個relay輸出警報，光伏模板效率改變時內建時鐘定時或遙控驅動清洗模板，二個數位輸入，偵測開關開路、閉路、避雷保護狀態經RS485傳送。



### VIM-C VIM-C 網路伺服器

Four RS485 ports, three USB 2.0 ports, one ethernet ports, 100 to 240VAC power supply, Wall/DIN-rail mounting type. Plant information, plant map for failure localization, webcam management, Real-time display with alarm indication, Graphical and analytical yield trends, Alarm and events logging.

四個RS485資料傳輸埠，三個USB2.0埠，一個乙太網路埠，電源100~240VAC，壁掛式、DIN導軌安裝，電廠信息，電廠圖示故障位址，網路攝影管理，即時顯示警告指示，圖形分析收益趨勢圖，警報和事件記錄。



### PSU18W, 30W, 60W 電源供應卡

PSU24181, PSU24031, PSU24061 input AC 90~265Vac DC 120~370Vdc, output 24VDC 18W Din-rail power supply.



內建30家以上協定持續增加  
適合屋頂型、小 / 中 / 大型 太陽能系統專用

內建免費 OPC 伺服軟體、可整合符合 SCADA 的驅動程式、  
提供所有 SCADA 系統整合廠商監測資料訊息平台。

stringMoni®  
監測每一串狀態

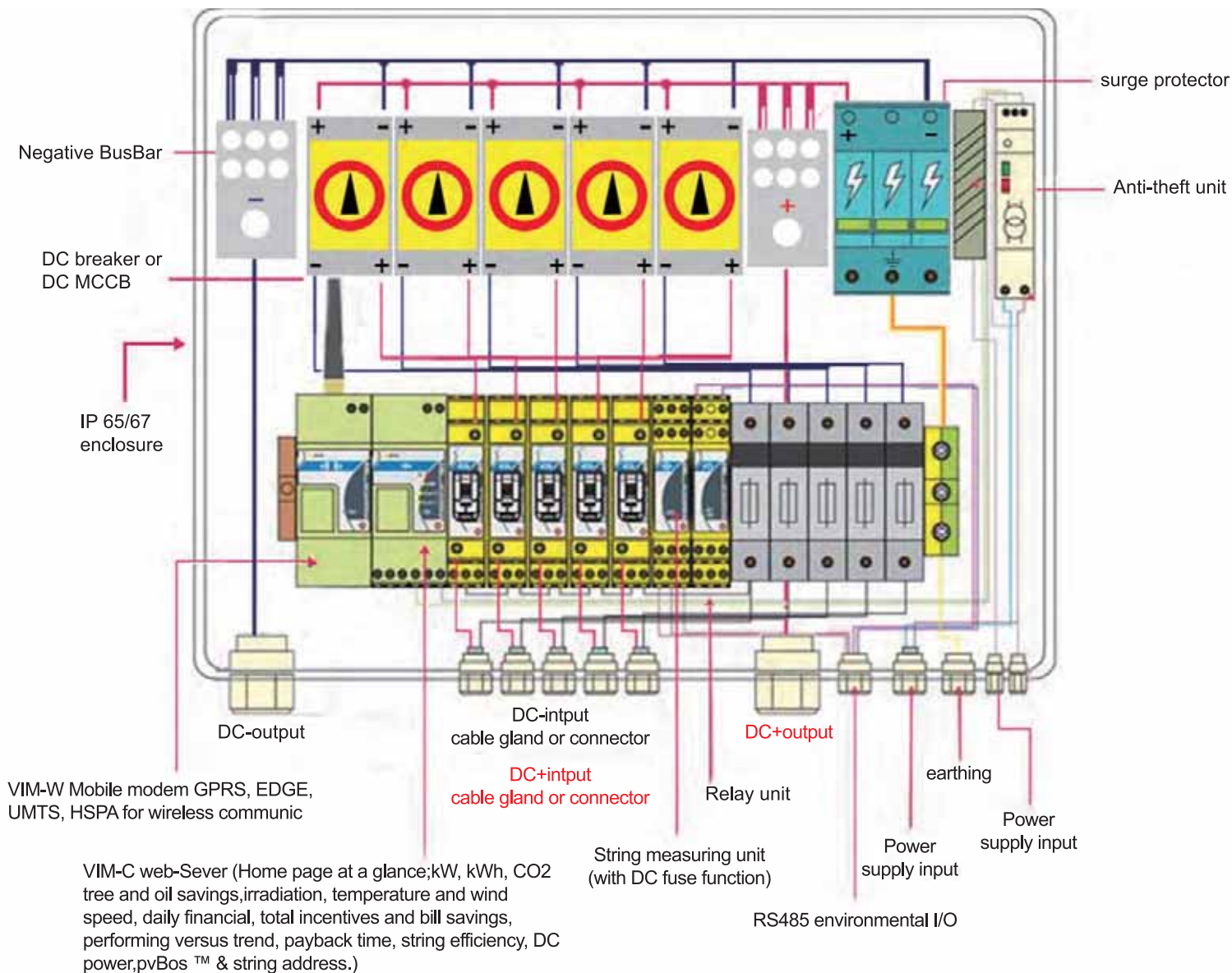

VIM-W Mobile modem GPRS, EDGE, UMTS, HSPA for wireless communic

VIM-C web-Sever (Home page at a glance; kW, kWh, CO2 tree and oil savings, irradiation, temperature and wind speed, daily financial, total incentives and bill savings, performing versus trend, payback time, string efficiency, DC power, pvBos™ & string address.)



產品優勢

- 易安裝：VIM-S 直接取代直流匯流箱正極保險絲，兼具保護及監測功能，不需更改原有箱體。
- 模組化：透過連接埠擴充模組，不需增加配線。
- 萬筆記錄：可透過 RS485 資料收集，及位址化。
- 量測每一串太陽能發電量，即時發現問題。
- 長期可節省成本、提早回收投資報酬率。

※ 電腦監控畫面，即時掌握發電狀況 ※

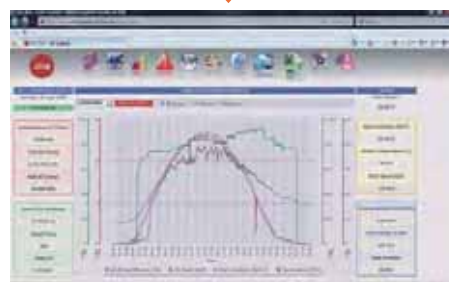



## SunOrbit®

### Professional

Human-Machine Interface: By providing information, alerts, commands and other tools, an HMI connects the user with the process being controlled.

### Flexible

Data interface is a widely accepted protocol due to its ease of use and reliability.

### Technology

Easily installation, high reliability



## iMorePV®

### Professional

Drive and positioning of Dual(or 2 Single) Axis Solar Trackers.

### Flexible

Data interface is a widely accepted protocol due to its ease of use and reliability.

### Reliable

Direct communication with the sunOrbit Solar Server via RS485 Service Interface. According to grid safety management, the product meets the requirements of the EU Medium-Voltage Directive.

### Technology

Easily installation, high reliability







不銹鋼浮筒水面漂浮太陽能电站支架系統是由本公司首創研發的一款水面漂浮式太陽能电站的載體。徹底解決了現有吹塑料浮筒抗紫外線差、易老化、加工週期長、使用壽命短、後期大量的塑料垃圾無法處理、汙染水質等問題。並且大幅度降低了水上漂浮式太陽能电站浮體的周期成本。

### 不銹鋼水面漂浮式支架技術參數

#### Technical Parameters of Stainless Steel floSolar® Mounting system

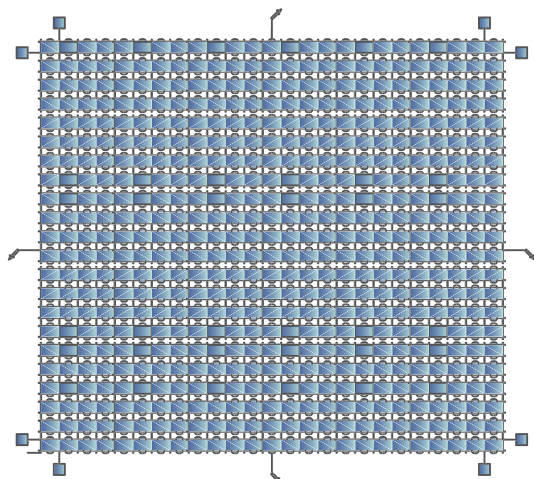

浮體浮力 Buoyancy of pontoon	每個浮桶工作浮力40kg 最大浮力 181 kg 40kg working, 181 kg max.
發電增效 Increased power output	比地面或屋頂电站提高6-12%以上的發電量 Higher than ground or rooftop 6-12% or more
組件規格 Specifications of components	1650*992mm-1950*992mm · 鋁合金邊框 · 雙玻璃電池組件 1650*992mm-1950*992mm, aluminum alloy frame, and double-glass solar module assembly
陳列形式 Array	橫向佈置/豎向佈置 · 每個陳列 4 Kw - 1 Mw Horizontal or Vertical, 4 Kw - 1 Mw per array
組件角度 Angle of assembly	5°- 45° 5°- 45°
浮體材質 Material of floating unit	316~304 不銹鋼 Stainless steel 316-304
扣合形式 Snap fit	不銹鋼浮體蝕水面無焊縫 · 耐腐蝕 · 防滲漏 Free of weld at the contact of the stainless steel pontoon with water, corrosion-resistant and seepage-proof
浮體年限 Pontoon life	使用壽命25年 25 years service life
抗風等級 Wind-resistant rating	最大抗風等級17級, 更高 65 m/s 已達風機極限 Up to 17 wind beaufort scade, more 65m/s ( testing rig limitation )



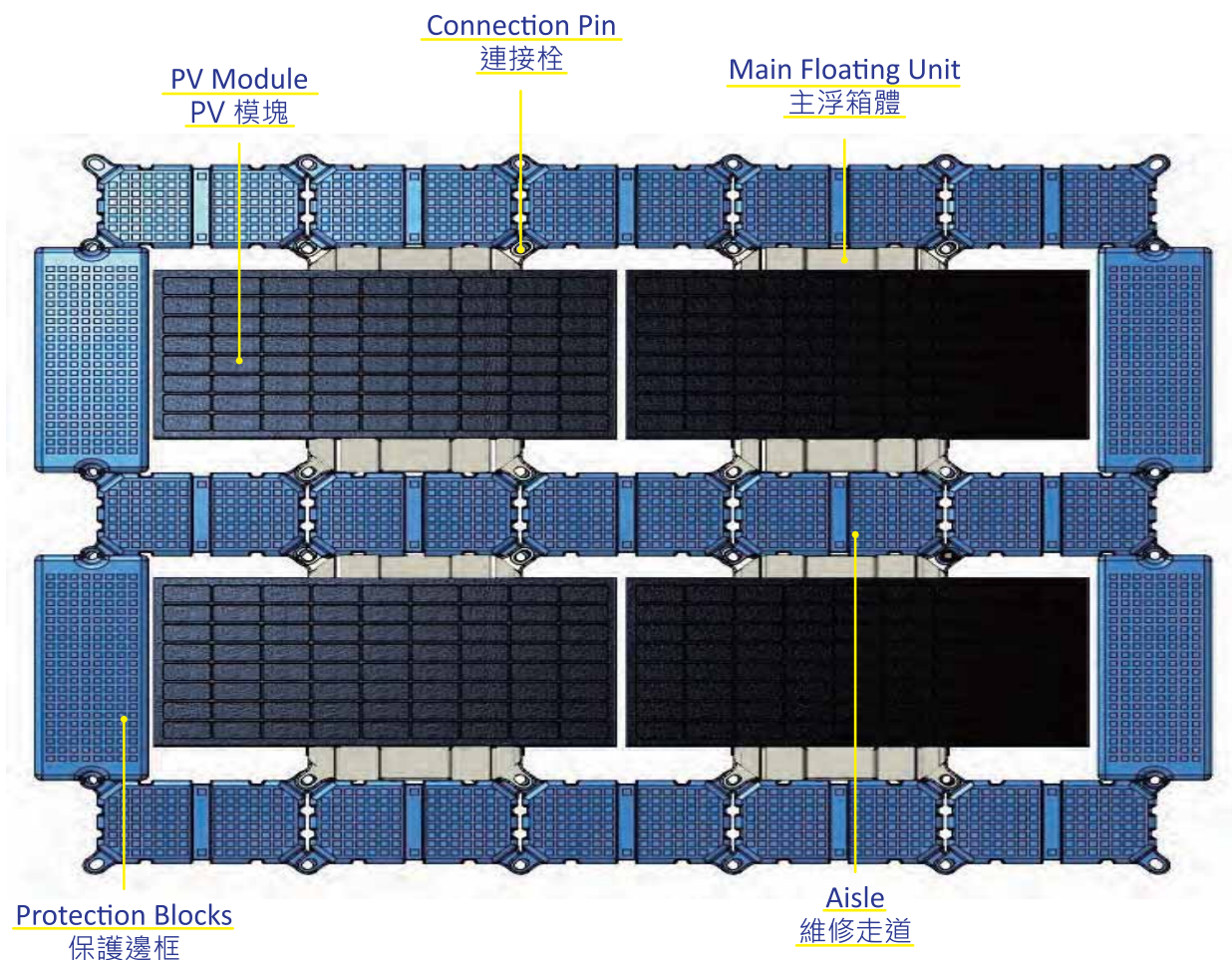

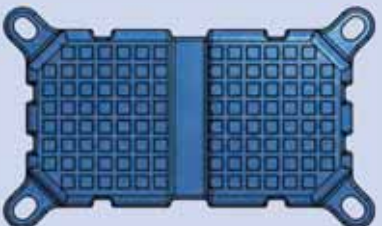

- Convenience for the subsequent operation and maintenance, at the same time tightly connected to the main floating body, ensure the stability of the entire PV island station.  
便於後續操作和維護，同時緊密連接主體浮台，確保整個光伏電站的穩定性。
- With non slip texture, to further protect the customers safety.  
具有防滑紋理，進一步保護客戶的安全。

floPV® 維修走道	floPV® 保護邊框	
 <p>6.5 kg 880 × 480 × 230 厚度(thk.): 4~5mm</p>	 <p>7 kg 1300 × 480 × 230 厚度(thk.): 4~5mm</p>	
<p>Material 材料</p>	<p>High density polyethylene(HDPE), in accordance with the Hunt water absorption test, including anti aging, anti ultraviolet, etc.</p>	
<p>Function 功能</p>	<p>Ensure that modules no shadows and the aisle with anti slip texture.</p>	



### DC Surge protection device 直流突波吸收器 600VDC

Nominal voltage 600Vdc, In 20-40KA, I<sub>max</sub> 25-50KA, IEC61643-11:2005, UL1449 ed. 3, EN505839 with aux. relay output.  
PV 40/600 直流突波吸收器：600Vdc, In 10-70KA, I<sub>max</sub> 25-150KA, IEC61643-11:2005, UL1449 ed.3。



### DC Surge protection device 直流突波吸收器 1000VDC

Nominal voltage 1000Vdc, In 20-40KA, I<sub>max</sub> 40-80KA, IEC61643-11:2005, UL1449 ed. 3, EN505839 with aux. relay output.  
PV 40/1000 直流突波吸收器：1000Vdc, In 20-40KA, I<sub>max</sub> 40-80KA, IEC61643-11:2005, UL1449 ed.3。



### AC Surge protective devices 交流突波吸收器 D1-50/\*\*\*-2MV-R

直流交流單相突波保護器：最大連續使用電壓75~800Vdc · 最大放電電流40KA · 突波保護等級0.3~2.0KV · 無洩漏電流 · DIN導軌安裝模組化設計 · 模塊插拔更換 · 熱保護脫扣設計 · 內建滅弧裝置 · 紅色落牌故障警示 · 常開長閉故障信控輔助接點。  
Single phase power supply system, max.discharge current 40KA, MCOV from 75 to 800Vdc, Inbuilt Arc-extinguishing device, Im 40KA, Up 0.3 to 2.0KV, no leakage current, DIN rail mounting, modular design, red sign fault indication, remote aux. relay 1NO 1 NC.



### AC Surge protective devices 交流突波吸收器 D3-50/\*\*\*-4MV-R

直流交流單相突波保護器：複合型變阻與氣體放電管技術 · 最大連續使用電MCOV150~800Vac/dc · 高放電能量class I/12.5KA class II /50KA · 適合戶外一級雷及戶內二級雷應用 · 突波保護等級0.5~1.6KV/3KA · 無洩漏電流 · DIN導軌安裝模組化設計 · 模塊插拔更換 · 熱保護脫扣設計 · 內建滅弧裝置 · 紅色落牌故障警示 · 常開長閉故障信控輔助接點。  
Single phase power supply system, AC and DC application 150 to 800V, max. discharge current 50KA class II, 12.5KA class I, Inbuilt Arc-extinguishing device, high energy MOV and GTD hybrid unit inside I<sub>max</sub> 100KA, V<sub>p</sub> up to 1.6KV at 3KA, no leakage current, DIN rail mounting, modular design, red sign fault indication, remote aux. relay 1NO 1 NC.

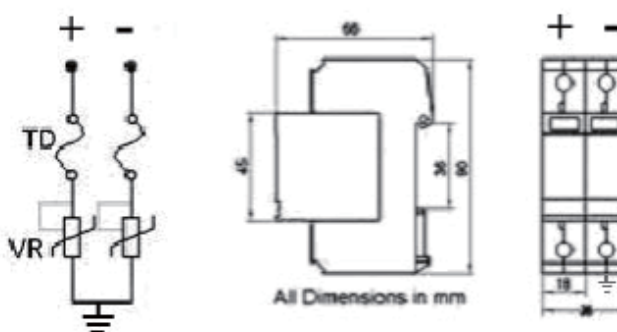

Common mode DC Surge arrester for Photovoltaic protection against surges at the boundaries from lightning protection zone OB-1 and higher.

- ◎ Class II (C) DC arrester in according with IEC61643-11 and UL1449-3rd.
- ◎ Two part design consisting of base and plug-in protection module.
- ◎ Common protection mode.
- ◎ High energy MOV (Metal Oxide Varistor) inside.
- ◎ Reliable supervision due to disconnection device.
- ◎ Fault indication by red indication flag in window.
- ◎ Fast response.
- ◎ With remote alarm terminal optional.



Type	PV 50/600-MVCR	
In accordance with	IEC61643 -11; UL1449 ed. 3	
Category IEC/VDE	II / C	
Protection Mode	Common mode	
Nominal voltage	600VDC	
Max. continuous operating voltage (DC)	670V DC	
Nominal discharge current (8/20) In	20KA	
Max. discharge current(8/20) I <sub>max</sub>	Per IEC61643	40KA
	Per UL1449	50KA
Voltage protection level@In per IEC61643	2.2K V	
VPR at 6KV/3KA per UL1449	<1.6KV	
Response time	≤ 25 ns	
Backup fuse(only required if not already provided in mains)	125A gR/gPV	
Operating temperature range	- 40°C + 80 °C	
Cross-section of connecton wire	Single-strand 35mm <sup>2</sup> ; multi-strand 25mm <sup>2</sup>	
Mounting	35mm DIN -rail in accordance with EN 50022/DIN46277-3	
Enclosure material	thermoplastic; extinguishing degree UL94 V0	
Degree of protection	IP20	
Installation width	2 modules, DIN 43880	
Thermal disconnecter	Internal green- normal red- failure	
Remote alarm contact	Yes	
<b>Additional data for Remote Alarm Contacts</b>		
Remote alarm contact type	floating changeover contact	
Switching capability U <sub>N</sub> /I <sub>N</sub>	AC: 250V/0.5A	DC: 250V/0.1A; 125V/0.2A; 75V/0.5A
Cross-section of connection wire	Max. 1.5mm <sup>2</sup>	

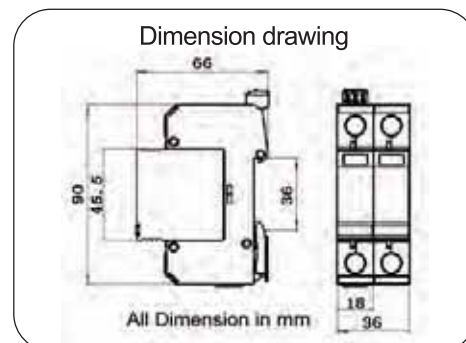
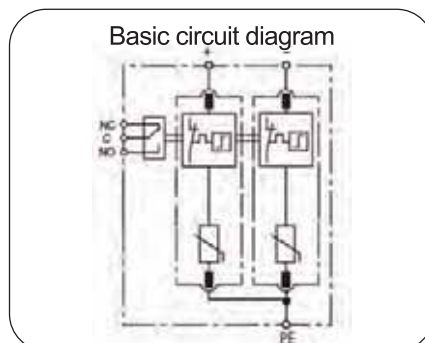

Type 2 SPD designed for low voltage system protection against surges at the boundaries from lightning protection zone 1-2 and higher.

- ⊙ Class II surge protector for Photovoltaic system
- ⊙ IEC61643-31, EN50539 compliance
- ⊙ Type 2, common mode surge protection, 40kA surge arrester
- ⊙ Pluggable design SPD, easy replacement
- ⊙ Reliable supervision due to disconnection device
- ⊙ Fault indication by red indication flag in window
- ⊙ With remote alarm terminal optional

Part No.	PV40/1000-MVCR	
In accordance with	IEC61643-31, EN50539	
Category IEC/VDE	II/ C	
Protection Mode	Common mode	
Nominal voltage (Vdc)	Un	1000
Max. continuous operating voltage (Vdc)	Ucpv	1060
Nominal discharge current(8/20)	In	20kA
Max. discharge current(8/20)	Imax	40kA
Voltage protection rating	Up	<3.6kV
Short-circuit current rating(Iscpv)	1000A	
Response time	≤ 25ns	
Follow current	No	
Backup fuse(only required if not already provided in mains)	125A gR/gPV	
Operating temperature range	- 40°C ~ + 80°C	
Cross-section of connection wire	Single-strand 35mm <sup>2</sup> ; multi-strand 25mm <sup>2</sup>	
Mounting	35mm DIN-rail in accordance with EN 50022/DIN46277-3	
Enclosure material	thermoplastic; extinguishing degree UL94 V-0	
Degree of protection	IP20	
Installation width	2 modules, DIN 43880	
Thermal disconnecter	Internal green – normal ; red - failure	
Remote alarm contact	Optional	
Approvals, Certifications	CE	
Remote alarm contact type	Isolated Form C	
Switching capability Un/In	AC: 250V/0.5A DC: 250V/0.1A; 125V/0.2A; 75V/0.5A	
Max. Size of connecting wire	Max. 1.5mm <sup>2</sup> (or # 16AWG)	



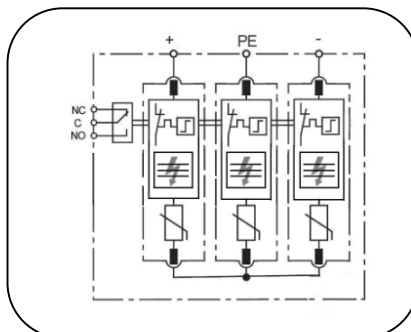

Basic circuit diagram

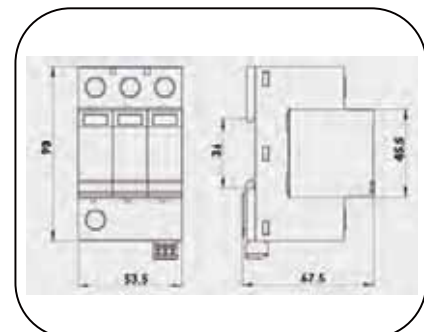

Dimension drawing

Type 1 SPD designed for low voltage system protection against surges at the boundaries from lightning protection zone 1-2 and higher.

- Type 1 surge protective devices for PV/ Photovoltaic system.
- DC SPD for common mode & Differential mode protection
- ETL certified surge protector according to UL1449-4th, SCCR 200kArms
- Pluggable design with window fault indication
- Nominal discharge current  $I_n$  20kA 8/20 per pole, max discharge current  $I_{max}$  50kA 8/20 per pole
- High reliability due to global patented thermally protected MOV (TPMOV) with special arc-extinguish device

Part No.		PV50-600-MVCDR	PV50-750-MVCDR	PV50-1000-MVCDR	PV50-1200-MVCDR
In accordance with		UL1449-4th			
Category IEC/VDE		Type1 CA			
Protection Mode		Common mode & Differential mode			
Nominal voltage (Vdc)	$U_n$	600	750	1000	1200
Max. permitted DC voltage	$V_{pvdc}$	660	840	1120	1420
Nominal discharge current(8/20)	$I_n$	20kA			
Max. discharge current(8/20)	$I_{max}$	50kA			
Voltage protection rating per mode	VPR	<1.0kV	<1.2kV	<1.5kV	<1.5kV
Voltage protection rating ("+" - PE)		<2kV	<2.4kV	<3kV	<3kV
Leakage (Quiescent) current	$I_q$	<2.5μA	<3.5μA	<2.5μA	<2.0μA
Short Circuit Current Rating	SCCR	200kA			
Response time		≤ 25ns			
Backup fuse(only required if not already provided in mains)		125A gR/gPV			
Max Ambient temperature		- 40°C ~ + 80°C			
Cross-section of connection wire		Single-strand 35mm <sup>2</sup> ; multi-strand 25mm <sup>2</sup>			
Mounting		35mm DIN-rail in accordance with EN 50022/DIN46277-3			
Enclosure material		thermoplastic; extinguishing degree UL94 V0			
Degree of protection		IP20			
Installation width		3 modules, DIN 43880			
Thermal disconnect		Internal green - normal; red - failure			
Remote alarm contact		"-S" means with remote alarm contact			
Approvals, Certifications		ETL/CE			
Remote alarm contact type		Isolated Form C			
Switching capability $U_n/I_n$		AC: 250V/0.5A DC: 250V/0.1A; 125V/0.2A; 75V/0.5A			
Max. Size of connecting wire		Max. 1.5mm <sup>2</sup> (or # 16AWG)			

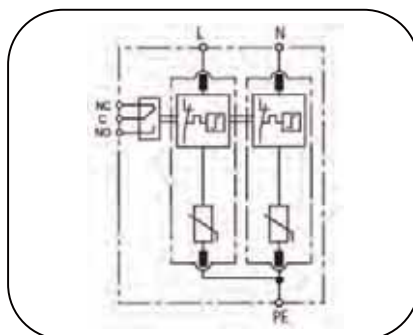

Basic circuit diagram

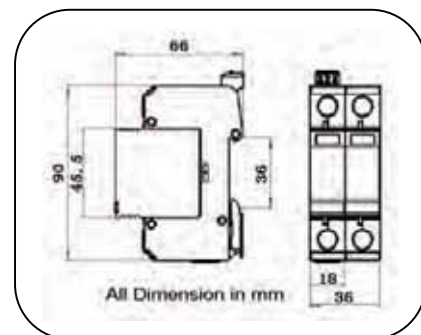

Dimension drawing

Type 1CA surge protective device especially designed for low-voltage power supply system at the boundaries from lightning protection zone 1-2 and higher.

- Type 1CA surge suppressor, passed intermediate current 100A, 500A, 1000A and short circuit current rating (SCCR) 200kA without external fuse or circuit breaker.
- ETL certified surge protector according to UL1449-4th
- Pluggable design with window fault indication
- Nominal discharge current  $I_n$  20kA 8/20 per pole, max discharge current  $I_{max}$  50kA 8/20 per pole
- High reliability due to global patented thermally protected MOV (TMOV) with special arc-extinguish device

Part No.	D1-50-150-2MV-R	D1-50-180-2MV-R	D1-50-250-2MV-R	D1-50-275-2MV-R	D1-50-320-2MV-R	D1-50-420-2MV-R	D1-50-510-2MV-R	D1-50-550-2MV-R
In accordance with	UL1449-4th							
Category IEC/VDE	Type1CA							
Max. continuous operating voltage MCOV (VAC/VDC)	150 /200	180 /240	250 /330	275 /370	320 /420	420 /560	510 /670	550 /710
Nominal discharge current(8/20) $I_n$	20kA							
Max. discharge current(8/20) $I_{max}$	50kA							
Voltage protection rating @ VPR	<0.7kV	<0.7kV	<1.0kV	<1.0kV	<1.2kV	<1.5kV	<1.5kV	<1.5kV
Response time	≤ 25ns							
Follow current	No							
Backup fuse(only required if not already provided in mains)	125A gL/gG							
Operating temperature range	- 40°C ~ + 80°C							
Cross-section of connection wire	Single-strand 35mm <sup>2</sup> ; multi-strand 25mm <sup>2</sup>							
Mounting	35mm DIN-rail in accordance with EN 50022/DIN46277-3							
Enclosure material	thermoplastic; extinguishing degree UL94 V0							
Degree of protection	IP20							
Installation width	2 modules, DIN 43880							
Thermal disconnecter	Internal green – normal ; red - failure							
Remote alarm contact	Optional							
SCCR rating	200kA							
Approvals, Certifications	ETL/CE							
Remote alarm contact type	Isolated Form C							
Switching capability $I_n/I_n$	AC: 250V/0.5A DC: 250V/0.1A; 125V/0.2A; 75V/0.5A							
Max. Size of connecting wire	Max. 1.5mm <sup>2</sup> (or # 16AWG)							

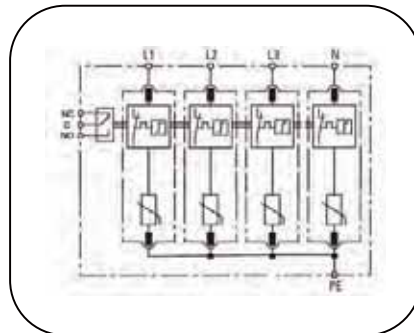

Basic circuit diagram

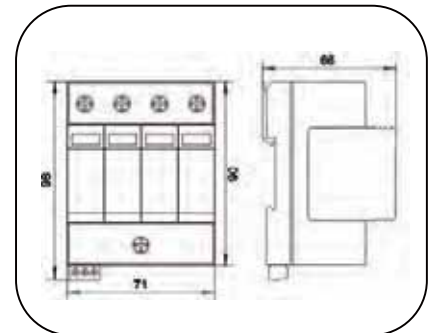

Dimension drawing

Type 1 surge protective device especially designed for low-voltage power supply system at the boundaries from lightning protection zone 1-2 and higher.

- Type 1CA surge protector, passed intermediate current 100A, 500A, 1000A and short circuit current rating (SCCR) 200kA without external fuse or circuit breaker.
- ETL certified surge protector according to UL1449-4th
- Pluggable design with window fault indication
- Nominal discharge current  $I_n$  20kA 8/20 per pole, max discharge current  $I_{max}$  50kA 8/20 per pole
- High reliability due to global patented thermally protected MOV (TMOV) with special arc-extinguish device

Part No.	D3-50/150-4MV-R	D3-50/180-4MV-R	D3-50/250-4MV-R	D3-50/275-4MV-R	D3-50/320-4MV-R	D3-50/420-4MV-R	D3-50/510-4MV-R	D3-50/550-4MV-R
In accordance with	UL1449-4th							
Category IEC/VDE	Type1CA							
Max. continuous operating voltage MCOV (VAC/VDC)	150 /200	180 /240	250 /330	275 /370	320 /420	420 /560	510 /670	550 /710
Nominal discharge current(8/20) h	20kA							
Max. discharge current(8/20) $I_{max}$	50kA							
Voltage protection rating @ VPR	<0.7kV	<0.7kV	<1.0kV	<1.0kV	<1.2kV	<1.5kV	<1.5kV	<1.5kV
Response time	≤ 25ns							
Follow current	No							
Backup fuse(only required if not already provided in mains)	125A gL/gG							
Operating temperature range	- 40°C ~ + 80°C							
Cross-section of connection wire	Single-strand 35mm <sup>2</sup> ; multi-strand 25mm <sup>2</sup>							
Mounting	35mm DIN-rail in accordance with EN 50022/DIN46277-3							
Enclosure material	thermoplastic; extinguishing degree UL94 V0							
Degree of protection	IP20							
Installation width	4 modules, DIN 43880							
Thermal disconnect	Internal green – normal ; red - failure							
Remote alarm contact	Optional							
SCCR rating	200kA							
Approvals, Certifications	ETL/CE							
Remote alarm contact type	Isolated Form C							
Switching capability Un/In	AC: 250V/0.5A DC: 250V/0.1A; 125V/0.2A; 75V/0.5A							
Max. Size of connecting wire	Max. 1.5mm <sup>2</sup> (or # 16AWG)							



### Data Network Protector for high-frequency signal transmission 訊號突波保護器DN-05/XXXX-\*\*

插拔模塊 · DIN rail安裝 · 8/20us電流波In.5KA · 箝制電壓(保護水平) 25V,-95V · 溫域-40~+80°C · 阻燃UL94-V0 · 另有指示燈規格可選。

Signal transmission, surge protective devices with plug-in protection modules for high-frequency signal transmission systems against surges at the boundaries from lightning protection zone 0B>2, Signal transmission is not interrupted when exchanging modules, max. discharge current 10KA, 35 mm DIN-rail mounting design.



### Data Network Protector for high-frequency signal transmission 訊號突波保護器DN-05/xxxx-2G

插拔模塊 · DIN rail安裝 · 8/20us電流波In.10KA · 箝制電壓(保護水平) 25V,-95V · 溫域-40~+80°C · 阻燃UL94-V0。

Signal transmission, surge protective devices with plug-in protection modules for high-frequency signal transmission systems against surges at the boundaries from lightning protection zone 0B>2, max. discharge current 20KA, 35 mm DIN-rail mounting design.



### Data Network Protector for analogue telecommunication 訊號突波保護器DN-xxx/S2A

指示燈 · 插拔模塊 · DIN rail安裝 · 組合波8/20us · In.5KA · 組合波10/350US 10KA · 箝制電壓(保護水平) Line-Line ≤700V-1000V · 溫域-40~+80°C · 阻燃UL94-V0。

Data network protector in according with IEC61643-11 : 21, Two parts design, surge protection modules to be exchanged easily, Signal transmission is not interrupted when exchanging modules, Limit the transients with gas discharge tubes and varistors, Two-stage protection circuit, For universal analogue tele-communication protection, 35 mm DIN-rail mounting design.

Model No.	DN-05/RS485-2G-B	DN-24/0420-2G
Appliance	xxxx:RS232,RS422,RS423,RS485,0/4-20mA,0-5V,0-10V	
Configuration	twisted pair + shield	
Nominal line voltage (Un)	5V	
Max line voltage	8V	
Max line current	300mA	
Nominal Discharge Current (8/20μs,KA) In 10 times	10kA	
Total Max. Discharge Current (8/20μs,KA) I <sub>max</sub> 1 time	20kA	
Impulse current (I <sub>imp</sub> ) (10/350us KA) impulse 2 times	5kA	
Nominal Current (A) I <sub>L</sub>	0.5A	
Protection level(U <sub>p</sub> ) 8/20us impulse-5KA	35V	
Series impedance per line (Ohm)	2.2 Ohm	
Insertion loss at 10MHz (dB)	≤3.0	
Degree of protection	IP20	
Mounting on	35 mm DIN-rail	
Enclosure Material	UL94 V0	
Environment Temperature (°C)	- 40~+80	
Cat.B(@3KA)		≤ 75V





### PV string combiner box stringMoni® 智慧型直流匯流箱

IP65/67 · 500, 800, 1000Vdc · 1, 2, 3, 4, 6, 8, 12, 16, 24串列組合 · VDE 0100 and IEC 60364-7-712, IEC 62109-4 · stringMoni IP 65/67, 500-1000Vdc, 1, 1,2,3,4,6,8,12,16,24 strings, Monitoring and protect each string, solve problems immediately. All the most significant data are transmitted via RS 485.



### PV string combiner box with surgeCon 24迴路串列匯流箱

二十四串輸出 · 配置IP67防水箱 · 8P 1000Vdc直流開關 6個或 12P 1000Vdc直流開關 4個, 直流保險絲及座24個(12個負或12個正), 突波保護器24個 · 適用50-60kW逆變器。

24 strings combiner box for 2 SPD. Configured with IP67 enclosure, 6 pcs 8 pole 1000Vdc DC disconnect or 4 pcs 12 poles 1000Vdc DC disconnect, PV fuse 24 pcs, alternative 12pcs positive only, surge protector 2pcs, for 5~60KW PV inverter.



### PV string string combiner box with surgeCon 串列匯流箱附雷擊計數器

二串輸出 · 配置IP67防水箱 · 4P 1000Vdc直流開關1個或2P二個 · 直流保險絲及座4個(正負極各2個) · 突波保護器1個 · 適用二只追蹤器之逆變器 · 1個雷擊計數器 · 4~6KW用或依開關電流額定適用10~25KW。

Two strings combiner box with surge counter SurgeCon for 2MPPT tracker. Configure with IP67 enclosure, 4 pole 1000Vdc DC disconnectors or 2pcs 2 pole 1000Vdc DC disconnect, PV fuse 4pcs, DC surge protector 2 pcs, SurgeCon 1pc, for 4~6KW PV system or for 10~25KW in according with rated current of DC disconnect switch, IEC 62109-4.



### AC Box AC交流開關箱

交流開關箱：多數歐盟國家規定必須裝置交流斷路器、漏電斷路器、突波(過壓)保護器 · 箱體配置歐式端子並予結線 · 現場安裝節省成本與時間 · 除了歐規還有美規以及接受客製。

AC Combiner box with MCCB, AC surge protector.



### Energy meter 單相瓦時表 WHM10-DIN

單相瓦時表 · DIN導軌安裝 · IP40保護 · 免電源 · 32A · 5位數LCD · 一個脈衝輸出。

One-phase energy meter with LCD data displaying, indicated for active energy metering. Housing for DIN-rail mounting, IP40 (front) protection degree. Direct connection up to 32A.

## 產品規格 Product Characteristics

防水防塵等級 Ingress Protection Water, dust-proof grade IP66/67, Degree of strength IK07/08

材質 Material quality : A:ABS , C:PC , P:PC/ABS

耐溫 Critical temperature : ABS : -40°C -+85°C ; PC: -40°C-+120°C

耐熱 Burn poorly : PC/ABS : 0-5VA ; ABS : 94-V-0

型號 Products Type : P series / H series / S,M series / D series

P series : Hinge type



H series : stainless hinge type



S/M series : screw type



D series : All-in-one-Dual door



## Accessories



Steel back panel  
(zinc plating)



plastic mounting  
plates (ABS)



Lock catch  
(K40)



Locker  
(SK)



plastic locker  
(PK)



JDA-PSK



JDA-PSK



Vent  
(V60, V80)



Plastic bracket  
(PB20, 25)



### Growatt 1-3K-S 組串型逆變器

Double MPPT Tracker, MPPT tracking accuracy more than 99.5%Max. Efficiency 97.9%, European Efficiency 97.4%Integrated DC switch for added safety protection  
最高效率97.9% · 寬電壓輸入範圍 · 內置直流開關 · GT拓撲結構設計 · 無變壓器 · 無風扇設計 · 多路MPPT技術 · 多路並聯組串 · IP65設計 · 聲控LCD · 安裝簡單。



### Growatt 2.5-5K MTL-S 組串型逆變器

Double MPPT Tracker, MPPT tracking accuracy more than 99.5%Max. Efficiency 97.9%, European Efficiency 97.4%Integrated DC switch for added safety protection  
最高效率97.9% · 寬電壓輸入範圍 · 內置直流開關 · GT拓撲結構設計 · 無變壓器 · 無風扇設計 · 多路MPPT技術 · 多路並聯組串 · IP65設計 · 聲控LCD · 安裝簡單。



### Growatt 7-11K TL3-S 組串型逆變器

DC input voltage up to 1000V Maximum efficiency of 98.4% Internal DC switch Transformerless Compact design Multi MPP controller MTL-string Bluetooth/ RF technology/ Zigbee/ Wi-Fi Sound control and Easy installation.

高達1000V的直流輸入電壓 · 最高效率98.4% · 寬電壓輸入範圍 · 內置直流開關 · GT拓撲結構設計 · 無變壓器設計 · 多路MPP技術 · IP65設計 · 雙獨立MPPT和高級MPPT算法可達到最佳能量採集。



### Growatt 30-50K TL3-S 組串型逆變器

Maximum efficiency of 99%, Compact design, Sound control Multi MPP controller Maximum efficiency of 99% Compact design Sound control Multi MPP controller MTL string, Internal DC switch and Optional AC switch.

該系列產品擁有99%的轉換效率和業界最高的防雷等級  
完善的保護功能 · 廣泛適用於分佈式光伏電站/大型地面電站/漁光互補/農光互補等電站類型。



### Growatt 60-80K TL3-H 組串型逆變器

Maximum efficiency of 99%, Compact design, DC and AC power supply, 24h monitoring, Type II surge arrester for both DC and AC, fits to hilly ground or larger rooftop.

該系列產品擁有99%的轉換效率和業界最高的防雷等級 · 直交流雙供電 · 24小時實時監控  
內建交直流二級防雷 · 全方位防雷保護完善的保護功能 · 廣泛適用於複雜場景 · 降低失配損失。

	Growatt 1000-S	Growatt 1500-S	Growatt 2000-S	Growatt 3000-S
<b>輸入數據(直流) Input Data</b>				
最大直流輸入功率 Max. recommended PV power (for module STC)	1300W	1900W	2300W	3400W
最大直流輸入電壓 Max. DC voltage	450V	450V	450V	550V
啟動電壓 Start voltage	80V	80V	80V	80V
直流輸入電壓範圍 PV voltage range	70V-450V	70V-450V	70V-450V	70V-550V
MPPT 工作電壓範圍/ 額定輸入電壓 MPP work voltage range/ nominal voltage	70V-450V/180V	70V-450V/250V	70V-450V/250V	70V-550V/360V
滿載DC工作電壓範圍 Full load dc voltage range	110V-400V	175V-400V	200V-400V	250V-440V
最大直流輸入電流 Max. input current	10A	10A	11A	13A
各組串最大直流輸入電流 Max. input current per string	10A	10A	11A	13A
MPP 追蹤器數量/各追蹤器 最大併聯組串數 Number of independent MPP trackers /strings per MPP tracker	1/1	1/1	1/1	1/1
<b>輸出數據(交流) Output (AC)</b>				
額定交流輸出功率 Rated AC output power	1000W	1600W	2000W	3000W
最大交流輸出功率 Max. AC power	1000W	1650W	2000W	3000W
最大交流輸出電流 Max. output current	4.7A	7.8A	9.5A	14.3A
額定輸出電壓; 範圍 AC nominal voltage; range	220, 230, 240V 180Vac-280Vac	220, 230, 240V 180Vac-280Vac	220, 230, 240V 180Vac-280Vac	220, 230, 240V 180Vac-280Vac
電網頻率; 範圍 AC grid frequency; range	50, 60 Hz; ±5 Hz	50, 60 Hz; ±5 Hz	50, 60 Hz; ±5 Hz	50, 60 Hz; ±5 Hz
功率因數 Power factor	1	1	1	1
THDI THDI	<3%	<3%	<3%	<3%
交流連接類型 AC connection	Single phase	Single phase	Single phase	Single phase
<b>效率 Efficiency</b>				
最大效率 Max. efficiency	97%	97%	97%	97%
歐洲加權效率 Euro weighted efficiency	95.5%	96.5%	96.5%	96.5%
MPPT效率 MPPT efficiency	99.5%	99.5%	99.5%	99.5%
<b>設備保護 Protection Devices</b>				
直流極性反接保護 DC reverse polarity protection	yes	yes	yes	yes
直流輸入開關 DC switch rating for each MPPT	yes	yes	yes	yes
交流輸出過壓保護 Output over current protection	yes	yes	yes	yes
交流輸出過壓保護-壓敏電阻 Output over voltage protection -varistor	yes	yes	yes	yes
接地故障監測 Ground fault monitoring	yes	yes	yes	yes
電網監測 Grid monitoring	yes	yes	yes	yes
內建全極性感應電流監測 Integrated all - pole sensitive leakage current monitoring unit	yes	yes	yes	yes
<b>常規數據 General Data</b>				
尺寸 (寬/高/深) Dimensions (W / H / D) in mm	271*267*127	271*267*127	271*267*127	320*261*142
重量 Weight	5.5KG	5.5KG	5.5KG	6.6KG
運行溫度範圍 Operating temperature range	- 25°C ... +60°C with derating above 45°C	- 25°C ... +60°C with derating above 45°C	- 25°C ... +60°C with derating above 45°C	- 25°C ... +60°C with derating above 45°C
噪音指數 (通常) Noise emission (typical)	≤ 25 dB(A)	≤ 25 dB(A)	≤ 25 dB(A)	≤ 25 dB(A)
海拔高度 Altitude	2000m(6560ft) without derating	2000m(6560ft) without derating	2000m(6560ft) without derating	2000m(6560ft) without derating
夜間自耗電 Self-Consumption night	<0.5 W	<0.5 W	<0.5 W	<0.5 W
拓撲結構 Topology	Transformerless	Transformerless	Transformerless	Transformerless
冷卻方式 Cooling concept	Natural	Natural	Natural	Natural
防護等級 Environmental Protection Rating	IP65	IP65	IP65	IP65
相對濕度 Relative humidity	100%	100%	100%	100%
<b>特點 Features</b>				
直流鏈接方式 DC connection	H4	H4	H4	H4
交流鏈接方式 AC connection	Connector	Connector	Connector	Connector
顯示 Display	LCD	LCD	LCD	LCD
通訊接口 Interfaces: RS232/ RF/ Wi-Fi/ Ethernet	yes /opt/opt/opt	yes /opt/opt/opt	yes /opt/opt/opt	yes /opt/opt/opt
質保期: 5年/10年 Warranty: 5 years / 10 years	yes /opt	yes /opt	yes /opt	yes /opt
<b>認證許可 Certificates and Approvals</b>				
	CE, VDE 0126-1-1, IEC 62109, G83, AS4777, AS/NZS 3100, CEI0-21, VDE-AR-N4105, EN0438, CQC			





		Growatt 2500MTL-S	Growatt 3000MTL-S	Growatt 3600MTL-S	Growatt 4200MTL-S	Growatt 5000MTL-S	Growatt 5500MTL-S
<b>輸入數據(直流) Input Data</b>							
最大直流輸入功率 Max. recommended PV power (for module STC)		2900W	3500W	4100W	4800W	5300W	5750W
最大直流輸入電壓 Max. DC voltage		500V	500V	550V	550V	550V	550V
啟動電壓 Start voltage		100V	100V	100V	100V	100V	100V
直流輸入電壓範圍 PV voltage range		70V-550V	70V-550V	70V-550V	70V-550V	70V-550V	70V-550V
追蹤器工作範圍 /正常電壓 MPP work voltage range /nominal voltage		80V-550V/360V	80V-550V/360V	80V-550V/360V	80V-550V/360V	80V-550V/360V	80V-550V/360V
滿載DC電壓範圍 Full load dc voltage range		130V-450V	160V-450V	190V-500V	150V-500V	160V-500V	175V-500V
追蹤器最大輸入 電流A/B Max. input current of tracker A /tracker B		10A/10A	10A/10A	10A/10A	15A/15A	15A/15A	15A/15A
最大串電流A/B Max. input current per string of tracker A/tracker B		10A/10A	10A/10A	10A/10A	15A/15A	15A/15A	15A/15A
追蹤器數 /每追蹤器併數 Number of independent MPP trackers / strings per MPP tracker		2/1	2/1	2/1	2/1	2/1	2/1
最大直流比, 依電壓電流 Max. DC ratio, depending on V, A		1.1~1.2	1.1~1.5	1.1~1.3	1.1~1.3	1.1~1.3	1.1~1.2
<b>輸出數據(交流) Output (AC)</b>							
額定交流輸出功率 Rated AC output power		2500W	3000W	3600W	4200W	4600W	5000W
最大交流視在功率 Max. AC apparent power		2500VA	3000VA	3600VA	4200VA	4600VA	5000VA
最大交流輸出電流 Max. output current		11.3A	13.6A	16.3A	19A	20.9A	22.7A
正常交流輸出電壓/範圍 AC nominal voltage/range		220V/230V/240V; 180Vac - 280Vac	220V/230V/240V; 180Vac - 280Vac	220V/230V/240V; 180Vac - 280Vac	220V/230V/240V; 180Vac - 280Vac	220V/230V/240V; 180Vac - 280Vac	220V/230V/240V; 180Vac - 280Vac
電網頻率/範圍 AC grid frequency/range		50Hz, 60Hz / ± 5 Hz	50Hz, 60Hz / ± 5 Hz	50Hz, 60Hz / ± 5 Hz	50Hz, 60Hz / ± 5 Hz	50Hz, 60Hz / ± 5 Hz	50Hz, 60Hz / ± 5 Hz
額定功率因數 Power factor at rated power		1	1	1	1	1	1
可配置位移功率因數 Displacement power factor, configurable		0.8leading... 0.95lagging	0.8leading... 0.95lagging	0.8leading... 0.95lagging	0.8leading... 0.95lagging	0.8leading... 0.95lagging	0.8leading... 0.95lagging
諧波 THDI		<3%	<3%	<3%	<3%	<3%	<3%
交流連接類型 AC connection		Single phase	Single phase	Single phase	Single phase	Single phase	Single phase
<b>效率 Efficiency</b>							
最大效率 Max. efficiency		97.6%	97.6%	97.9%	97.9%	97.9%	97.9%
歐洲加權效率 Euro weighted efficiency		97%	97%	97.4%	97.4%	97.4%	97.4%
追蹤器效率 MPPT efficiency		99.5%	99.5%	99.5%	99.5%	99.5%	99.5%
<b>設備保護 Protection Devices</b>							
直流極性反接保護 DC reverse polarity protection		yes	yes	yes	yes	yes	yes
直流輸入開關 DC switch rating for each MPPT		yes	yes	yes	yes	yes	yes
輸出過流保護 Output over current protection		yes	yes	yes	yes	yes	yes
輸出過壓保護 Output over voltage protection-varistor		yes	yes	yes	yes	yes	yes
接地故障檢測 Ground fault monitoring		yes	yes	yes	yes	yes	yes
電網監測 Grid monitoring		yes	yes	yes	yes	yes	yes
內建全極性感應 漏電流檢測裝置 Integrated all - pole sensitive leakage current monitoring unit		yes	yes	yes	yes	yes	yes
<b>常規數據 General Data</b>							
尺寸(寬/高/深) Dimensions (W / H / D) in mm		355*419*138	355*419*138	355*419*138	355*419*138	355*374*158	355*374*158
重量 Weight		14KG	14KG	14KG	14KG	14.5KG	14.5KG
運行溫度範圍 Operating temperature range		- 25°C ... +60°C	- 25°C ... +60°C	- 25°C ... +60°C	- 25°C ... +60°C	- 25°C ... +60°C	- 25°C ... +60°C
噪聲指數(典型) Noise emission (typical)		≤ 25 dB(A)	≤ 25 dB(A)	≤ 25 dB(A)	≤ 25 dB(A)	≤ 25 dB(A)	≤ 25 dB(A)
海拔高度 Altitude		2000m without derating	2000m without derating	2000m without derating	2000m without derating	2000m without derating	2000m without derating
夜間自耗電 Self-Consumption night		< 0.5 W	< 0.5 W	< 0.5 W	< 0.5 W	< 0.5 W	< 0.5 W
拓撲結構 Topology		Transformerless	Transformerless	Transformerless	Transformerless	Transformerless	Transformerless
冷卻方式 Cooling concept		Natural	Natural	Natural	Natural	Natural	Natural
防護等級 Environmental Protection Rating		IP 65	IP 65	IP 65	IP 65	IP 65	IP 65
相對濕度 Relative humidity		100%	100%	100%	100%	100%	100%
<b>特點 Features</b>							
直流鏈接方式 DC connection		H4/MC4(opt)	H4/MC4(opt)	H4/MC4(opt)	H4/MC4(opt)	H4/MC4(opt)	H4/MC4(opt)
交流鏈接方式 AC connection		Connector	Connector	Connector	Connector	Connector	Connector
顯示 Display		LCD	LCD	LCD	LCD	LCD	LCD
通訊接口 Interfaces: RS232/RF/WI-FI/ Ethernet		yes / opt / opt / opt	yes / opt / opt / opt	yes / opt / opt / opt	yes / opt / opt / opt	yes / opt / opt / opt	yes / opt / opt / opt
質保期: 5年/10年 Warranty: 5 years / 10 years		yes / opt	yes / opt	yes / opt	yes / opt	yes / opt	yes / opt
<b>認證許可 Certificates and Approvals</b>		CE, IEC62109, G83, VDE0126-1-1, G59, AS4777, AS/NZS 3100, CEIO-21, VDE-AR-N4105, EN50438, CQC					

**輸入數據(直流) Input Data**

	Growatt 7000 TL3-S	Growatt 8000 TL3-S	Growatt 9000 TL3-S	Growatt 10000 TL3-S	Growatt 11000 TL3-S
最大直流輸入功率 Max. recommended PV power (for module STC)	8400W	9600W	10800W	12000W	13200W
最大直流輸入電壓 Max. DC voltage	1000V	1000V	1000V	1000V	1000V
啟動電壓 Start Voltage	160V	160V	160V	160V	160V
直流輸入電壓範圍 PV voltage range	160V-1000V	160V-1000V	160V-1000V	160V-1000V	160V-1000V
正常電壓 Nominal voltage	600V	600V	600V	600V	600V
MPP電壓範圍 MPP voltage range at Full Power	600V	600V	600V	600V	600V
最大輸入電流 Max. input current	320V-850V	360V-850V	400V-850V	450V-850V	450V-850V
每串最大輸入電流 Max. input current per string	11.5A/11.5A	11.5A/11.5A	11.5A/11.5A	13A/13A	13A/13A
追蹤器數量/每追蹤器併數 Number of independent MPP trackers/strings per MPP tracker	2/1	2/1	2/1	2/1	2/1

**輸出數據(交流) Output (AC)**

額定交流輸出功率 Rated AC output power	7kW	8kW	9kW	10kW	11kW
最大交流視在功率 Max AC apparent power	7.7kVA	8.8kVA	9.9kVA	11kVA	12.1kVA
最大輸出電流 Max. output current	11.7A	13.3A	15A	16.7A	18.3A
最大輸出電流範圍 AC nominal voltage range	230V/400V 184~275V	230V/400V 184~275V	230V/400V 184~275V	230V/400V 184~275V	230V/400V 184~275V
交流電網頻率 AC grid frequency	50/60Hz	50/60Hz	50/60Hz	50/60Hz	50/60Hz
功率因數 Power factor	0.8leading - 0.8lagging	0.8leading - 0.8lagging	0.8leading - 0.8lagging	0.8leading - 0.8lagging	0.8leading - 0.8lagging
諧波 THDi @Full load&Thdv<1%	<3%	<3%	<3%	<3%	<3%
AC電網連接類型 AC grid connection type	3/N/PE	3/N/PE	3/N/PE	3/N/PE	3/N/PE

**效率 Efficiency**

最大效率 Max. efficiency	98.3%	98.3%	98.4%	98.4%	98.4%
歐洲加權效率 Euro - eta	97.5%	97.8%	98%	98%	98%
MPPT效率 MPPT efficiency	99.5%	99.5%	99.5%	99.5%	99.5%

**設備保護 Protection Devices**

直流反極性保護 DC reverse polarity protection	yes	yes	yes	yes	yes
每個MPP追蹤器直流開關 DC switch for each MPPT	yes	yes	yes	yes	yes
輸出過流保護 Output over current protection	yes	yes	yes	yes	yes
輸出過壓保護 - 壓敏電阻 Output AC overvoltage Protection - Varistor	yes	yes	yes	yes	yes
接地故障監控 Ground fault monitoring	yes	yes	yes	yes	yes
網格監控 Grid monitoring	yes	yes	yes	yes	yes
集成全極敏感洩漏電流監測單元 Integrated all-pole sensitive leakage current monitoring unit	yes	yes	yes	yes	yes

**常規數據 General Data**

尺寸(寬/高/深) Dimensions(W/H/D)	480/448/200 mm	480/448/200 mm	480/448/200 mm	480/448/200 mm	480/448/200 mm
重量 Weight	21.6kg	21.6kg	21.6kg	21.6kg	21.6kg
運行溫度範圍 Operating temperature range	-25 °C ... +60 °C	-25 °C ... +60 °C	-25 °C ... +60 °C	-25 °C ... +60 °C	-25 °C ... +60 °C
噪聲指數(典型) Noise emission (typical)	≤ 35 dB(A)	≤ 35 dB(A)	≤ 35 dB(A)	≤ 35 dB(A)	≤ 35 dB(A)
高度 Altitude	3000m	3000m	3000m	3000m	3000m
夜間自耗電 Self-consumption night	< 0.5W	< 0.5W	< 0.5W	< 0.5W	< 0.5W
拓撲結構 Topology	Transformerless	Transformerless	Transformerless	Transformerless	Transformerless
冷卻方式 Cooling concept	Natural	Natural	Natural	Natural	Natural
環境保護等級 Environmental Protection Rating	IP65	IP65	IP65	IP65	IP65
相對濕度 Relative humidity	0~100%	0~100%	0~100%	0~100%	0~100%

**特點 Features**

直流連接 DC connection	H4/MC4(opt)	H4/MC4(opt)	H4/MC4(opt)	H4/MC4(opt)	H4/MC4(opt)
交流連接 AC connection	Screw terminal	Screw terminal	Screw terminal	Screw terminal	Screw terminal
顯示 Display	LCD	LCD	LCD	LCD	LCD
通訊接口 Interfaces:RS232/RS485/RF/Ethernet/Wifi	yes/yes/opt/opt/opt	yes/yes/opt/opt/opt	yes/yes/opt/opt/opt	yes/yes/opt/opt/opt	yes/yes/opt/opt/opt
質保期: 5年/10年 Warranty:5 years/10 years	yes/opt	yes/opt	yes/opt	yes/opt	yes/opt

**認證許可 Certificates and Approvals**

eece, VFR 2014, VDE-AR-N4105, G83, EN50438, CEI 0-21, AS4777, IEC 61727, IEC 62116, CQC

**輸入數據(直流) Input Data**

	Growatt 30000TL3-S	Growatt 33000TL3-S	Growatt 40000TL3-NS	Growatt 50000TL3-S
最大直流輸入功率 Max recommended PV Power (用於模塊STC) (for module STC)	37500W	41250W	50000W	60000W
最大直流輸入電壓 Max DC voltage	1000V	1000V	1000V	1000V
啟動電壓 Start Voltage	250V	250V	250V	250V
直流輸入電壓範圍 PV voltage range	200V - 1000V	200V - 1000V	200V - 1000V	200V - 1000V
正常電壓 Nominal voltage	580V	580V	580V	695V
滿載MPP電壓範圍 Full load MPP voltage range	450V - 800V	450V - 800V	540V - 800V	645V - 850V
最大輸入電流 Max. input current	34A/34A	38A / 38A	38A / 38A	38A / 38A
每串最大輸入電流 Max. input current per string	12A	12A	12A	12A
追蹤器數量/ Number of MPP trackers / 每追蹤器組串數量 strings per MPP tracker	2/4	2/4	2/4	2/4

**輸出數據(交流) Output (AC)**

額定交流輸出功率 Rated AC output power	30kW	33kW	40kW	48kW
最大交流視在功率 Max. AC apparent power	33.3 kVA	36.6 kVA	44.4 kVA	53.3 kVA
最大交流輸出電流 Max. output current	48.3A	53A	64.5A	64.5A
額定交流輸出電壓 AC nominal voltage	230V/400V	230V/400V	230V/400V	277V/480V
電網頻率 AC grid frequency	50/60Hz	50/60Hz	50/60Hz	50/60Hz
功率因數 Power factor	0.8 leading - 0.8 lagging	0.8 leading - 0.8 lagging	0.8 leading - 0.8 lagging	0.8 leading - 0.8 lagging
諧波 THDi	<3%	<3%	<3%	<3%
交流電網連接類型 AC grid connection type	3W+N+PE	3W+N+PE	3W+N+PE	3W+N+PE/3W+PE

**效率 Efficiency**

最大效率 Max. efficiency	98.9%	98.9%	98.9%	99%
歐洲加權效率 Euro - eta	98.4%	98.4%	98.5%	98.5%
MPPT效率 MPPT efficiency	99.5%	99.5%	99.5%	99.5%

**設備保護 Protection Devices**

直流反極性保護 DC reverse-polarity protection	yes	yes	yes	yes
每個MPP追蹤器直流開關 DC Switch for each MPPT	yes	yes	yes	yes
交流開關 AC Switch	opt	opt	opt	opt
直流突波保護 DC Surge protection	Class II	Class II	Class II	Class II
接地故障監控 Ground fault monitoring	yes	yes	yes	yes
短入輸出保護 Output short circuit protection	yes	yes	yes	yes
交流突波保護 AC Surge protection	Class II	Class II	Class II	Class II
保險絲串保護 String Fuse protection	yes	yes	yes	yes
串列故障監測 String fault monitoring	yes	yes	yes	yes
抗PID保護 Anti-PID protection	yes	yes	yes	yes
AFCl(選項) AFCl protection	opt	opt	opt	opt

**常規數據 General Data**

尺寸(寬/高/深) Dimensions (W / H / D)	470/754/270 mm	470/754/270 mm	470/754/270 mm	470/754/270 mm
重量 Weight	48kg	48kg	48kg	48kg
運行溫度範圍 Operating temperature range	-25 °C ... +60 °C (with derating above45°C)	-25 °C ... +60 °C (with derating above45°C)	-25 °C ... +60 °C (with derating above45°C)	-25 °C ... +60 °C (with derating above45°C)
噪聲指數(典型) Noise emission (typical)	≤50 dB(A)	≤50 dB(A)	≤50 dB(A)	≤50 dB(A)
夜間自耗電 Self-Consumption (night)	<1W	<1W	<1W	<1W
拓撲結構 Topology	Transformerless	Transformerless	Transformerless	Transformerless
冷卻方式 Cooling concept	Smart cooling	Smart cooling	Smart cooling	Smart cooling
防護等級 Environmental Protection Rating	IP65	IP65	IP65	IP65
海拔高度 Altitude	2000m without derating	2000m without derating	2000m without derating	2000m without derating
相對濕度 Relative Humidity	0~100%	0~100%	0~100%	0~100%

**特點 Features**

顯示 Display	Graphic LCD	Graphic LCD	Graphic LCD	Graphic LCD
通訊接口 Interfaces: RS232/R485/WiFi/LAN/GPRS	yes / yes / opt / opt / opt	yes / yes / opt / opt / opt	yes / yes / opt / opt / opt	yes / yes / opt / opt / opt
質保期: 5年/10年 Warranty:5 years / 10 years	yes / opt	yes / opt	yes / opt	yes / opt

**認證許可 Certificates and Approvals**

CE, IEC 61727, IEC 62116, VDE 0126-1-1, Greece, VFR 2014, CEI 0-21, CEI 0-16, N4105, AS 4777, G59/3, PEA, MEA, IEC 60529, IEC 60068, IEC 61683, EN50438 (Turkey, Ireland, Poland, Switzerland, Norway, Sweden, Denmark)

**輸入數據(直流) Input Data**

	Growatt MAX 60000 TL3-H	Growatt MAX 70000 TL3-H	Growatt MAX 80000 TL3-H
最大直流電源 Max. DC power	78000W	91000W	104000W
最大直流輸入電壓 Max. DC voltage	1100V	1100V	1100V
啟動電壓 Start voltage	250V	250V	250V
額定電壓 Nominal voltage	700V	700V	700V
直流輸入電壓範圍 PV voltage range	200V-1000V	200V-1000V	200V-1000V
MPP電壓範圍(滿載) MPP voltage range (Full load)	500V-850V	600V-850V	685V-850V
最大 MPP 的輸入電流 Max. input current per MPPT	22A	22A	22A
MPPT路數 Strings per MPPT	2	2	2
追蹤器數量/每追蹤器併數 Number of MPP trackers/strings per MPP tracker	6/2	6/2	6/2

**輸出數據(交流) Output (AC)**

標準輸出功率 Rated AC output power	60000W	70000W	80000W
額定交流電壓 Max. AC apparent power	66600VA	77700VA	88800VA
交流電壓範圍 Max. output current	80.2A	93.6A	107A
標準交流電網頻率 AC nominal voltage / range	277V/480V	277V/480V	277V/480V
交流電網頻率範圍 AC grid frequency / range	50/60 Hz	50/60 Hz	50/60 Hz
功率因數 ( cosφ ) Power factor (cosφ)	0.8leading ...0.8lagging	0.8leading ...0.8lagging	0.8leading ...0.8lagging
諧波 THDi	<3%	<3%	<3%
交流電網連接類型 AC grid connection type	3W+PE	3W+PE	3W+PE

**效率 Efficiency**

最大效率 Max. efficiency	99%	99%	99%
歐洲加權效率 Euro-eta	98.5%	98.5%	98.5%
MPPT效率 MPPT efficiency	99.9%	99.9%	99.9%

**設備保護 Protection Devices**

直流反極性保護 DC reverse-polarity protection	yes	yes	yes
每個MPP追蹤器直流開關 DC switch for each MPPT	yes	yes	yes
交流開關 AC switch	Class II	Class II	Class II
輸入過壓突波保護器 DC surge protection	yes	yes	yes
直流絕緣測量 Ground fault monitoring	yes	yes	yes
交流短路保護 Output short circuit protection	yes	yes	yes
輸出過壓保護 - 壓敏電阻 AC surge protection	Class II	Class II	Class II
輸出過壓突波保護器 String fuse	No	No	No
串聯保險絲類型/尺寸(選件) String fault monitoring	yes	yes	yes
串聯保險絲類型/尺寸(選件) Anti-PID protection	yes	yes	yes
AFCI(選項) AFCI (Option)	opt	opt	opt

**常規數據 General Data**

尺寸(寬/高/深) Dimensions (W / H / D)	870/580/290mm	870/580/290mm	870/580/290mm
重量 Weight	82kg	82kg	82kg
運行溫度範圍 Operating temperature range	-25°C ... +60°C	-25°C ... +60°C	-25°C ... +60°C
噪聲指數(典型) Noise emission	≤ 55dB(A)	≤ 55dB(A)	≤ 55dB(A)
相對溼度 Relative Humidity	0-100%	0-100%	0-100%
高度 Altitude	4000m	4000m	4000m
夜間自耗電 Self-Consumption (night)	< 1W	< 1W	< 1W
拓撲結構 Topology	transformerless	transformerless	transformerless
冷卻方式 Cooling concept	smart fan cooling	smart fan cooling	smart fan cooling
電子保護等級 Electronics protection rating	IP 65	IP 65	IP 65

**特點 Features**

顯示 Display	LED/WIFI+APP	LED/WIFI+APP	LED/WIFI+APP
通訊接口 Interface:USB/RS485/WIFI/PLC	yes / yes / opt / opt / opt	yes / yes / opt / opt / opt	yes / yes / opt / opt / opt
質保期: 5年/10年 Warranty:10years/ 15 years	yes/opt	yes/opt	yes/opt

**認證許可 Certificates and Approvals**

CQC,CE,VDE 0126-1-1,VDE-AR-N4105,EN50438,AS 4777



# mppGuard®

distributed string optimizer for centralized PV system

## 集中式變流器專用智慧型發電機接線箱

The intelligent generator junction box for a central inverter

セントラルパワコン向けのスマート発電接続箱

內建串列監測・即時監測包括最大功率電壓、輸出電壓、直流電流及位址等參數值。

the mppGuard® is already integrated, all parameters will be measured such as Umpp, Uout, Adc, Temperature, ID etc.

技術資料 / technical data / テクニカルデータ			
靜止狀態下最大輸入電壓 max. input voltage in idle state 休止狀態最大入力電圧	950Voc DC	接線盒模組 junction modules 接続箱モジュール	插頭連結器/插座 (MC4或兼容) plug connector/ plug socket (MC4 or compatible) コネクタプラグ/コンセント (MC4と互換性ある部品)
最大功率工作電壓範圍 Working area MPP-Voltage 最大電力点電圧の可動範圍	300 V – 800 V DC	接線箱直流輸出 junction DC-output 接続箱直流出力	插頭連結器/插座 (MC4或兼容) plug connector/ plug socket (MC4 or compatible) コネクタプラグ/コンセント (MC4と互換性ある部品)
最大輸入電流/一迴路 max. input current/string 最大入力電流 (各ストリングあたり)	2 x 10 A DC Input power	接線傳輸/監測 junction communication / monitoring 接続箱のデータ転送・モニタリング	RS-485
輸入功率 Input power input power	15 kWp	冷卻 cooling 冷却	被動式冷卻 (自由対流) 可雲端控制 passive (free convection) web portal Control 受動性ウェブ管理 (自然対流)
最大輸出電壓 (中間電路) max. output voltage (Intermediate circuit) 最大出力電圧 (中間回路)	800 V DC	效能監視 performance monitoring 効率監視	決定模組最優操作點使全系統收益最佳化 determination of the optimal operating point of the modules allows a yield optimization of the system モジュールの最適動作点を決め、太陽光発電システムの収益性を最適化へ。
最小輸出電壓 (中間電路) min. output voltage (Intermediate circuit) 最低出力電圧 (中間回路)	590 V DC (20 V DC over input voltage)	最大功率追蹤任務 task of the MPP-Tracking 最大電力点追従	

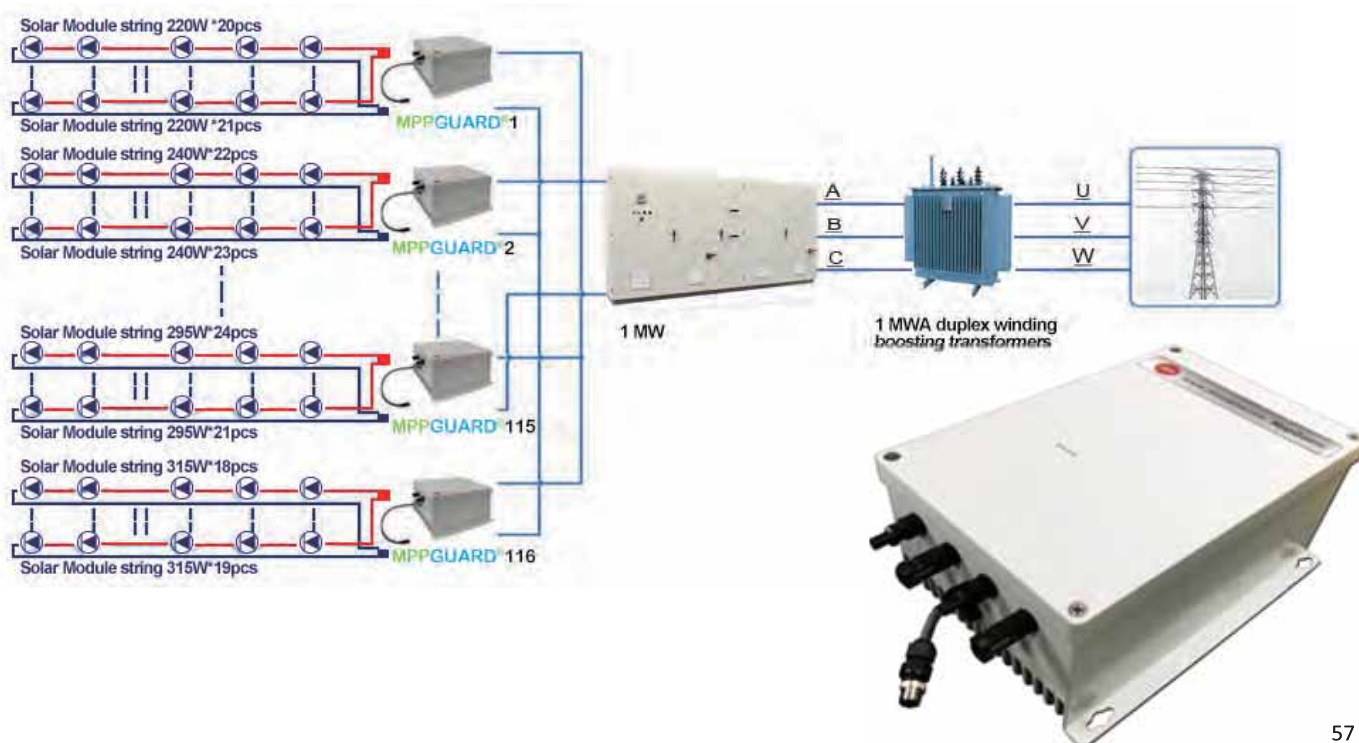



# ID-03 / ID-03.T

交流/直流/  
 儲能/電動汽車/  
 船舶牽引

- Designed to be used in demanding industrial environments up to 7200 VAC
- Functionality verification has included frequency converter applications
- Measures the insulation resistance and capacitance of AC/DC networks
- Detects also symmetrical insulation faults
- Suitable for different application fields, for example
  - AC drive installations
  - AC installations in demanding environments
  - Service and training facilities
  - DC networks
  - Electric vehicle DC charging stations
  - Marine and traction (ID-03.T)

## Power supply specifications

Nominal Input voltage	110-240 VAC, 110-300 VDC (Schurter 0001.2503 (T800mA))
Nominal input current	0.04 A at 230 VAC
Line frequency	48 ~ 62 Hz

## Measurement specification

Maximum input voltage	690 VAC / 800 VDC
Resistance measurement	20k Ω...5MΩ with better than range 15% accuracy
System frequency	DC, 10Hz - 500Hz
Measuring impedance	220kΩ
Test voltage	30Vp max

## Alarm contact with settable limit (potential free changeover)

Alarm contact	5A at 250VAC
---------------	--------------

## Other functions

RS-485 serial connection	
Modbus/TCP interface for remote monitoring and controlling	
Analog output of resistance measurement	4...20 mA, with current loop transmitter CT-03

High voltage couplers HVC-16AC, HVC-40AC and HVC-72AC enables insulation level monitoring of industrial isolated (IT) networks with voltages up to 1600 VAC, 4000 VAC or 7200VAC

Suitable also for frequency converter solutions

Compatible also with 3 phase IT networks

Self-testing automatic      Continuous

Self-testing immediate      With TEST button

## Standards

Measurements	IEC 61557-8:2014
Safety	IEC 61010-1:2010 (3 <sup>rd</sup> Edition), IEC 60664-1 and IEC 60664-3
EMC	IEC 61326-2-4, CISPR 11 / EN55011, IEC61000-4-2, IEC61000-4-3, IEC61000-4-4, IEC61000-4-5, IEC61000-4-6, IEC61000-4-11

Marine

## General

Dimension (W x L x D)	ID-03      106 x 110 x 62 mm CT-03      36 x 110 x 62 mm
Case Material	Plastic
Mounting interface	DIN rail clamp or screw mounting

## Insulation Monitoring device for Industrial applications

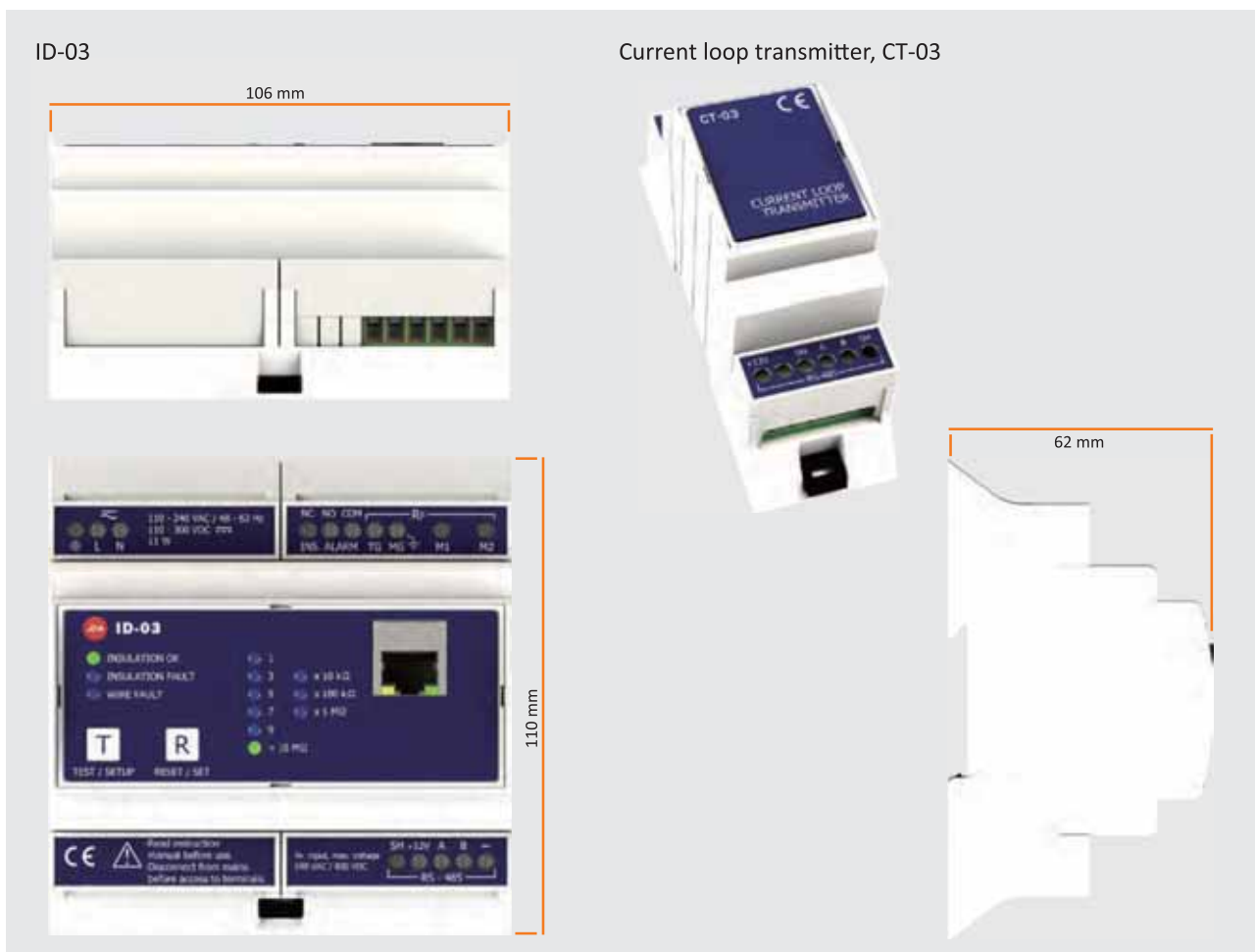

ID-03.T is able to withstand even more demanding conditions:

- Minimum temperature -25 °C
- Vibration
- Harsh humidity stress
- Maximum input voltage 400 VAC / 400 VDC
- Resistance measurement range 1...900k  $\Omega$
- Maximum system leakage capacitance 300uF

Possible installation locations include railway and marine applications.

ID-03 is available also without enclosure (ID-03.L) for device manufacturers.

All our insulation monitoring devices can be monitored remotely over the Internet, independently of distance and location.

# SCT-65 / SCT-80 HelliStar®

## MPPT solar charge controller

Maximize the energy generated from solar panels by adding a scTrack solar charge controller with maximum power point tracker (MPPT) to any solar installation.

65 or 80A / Battery voltage: 12-24-48V  
up to 150V input PV voltage range

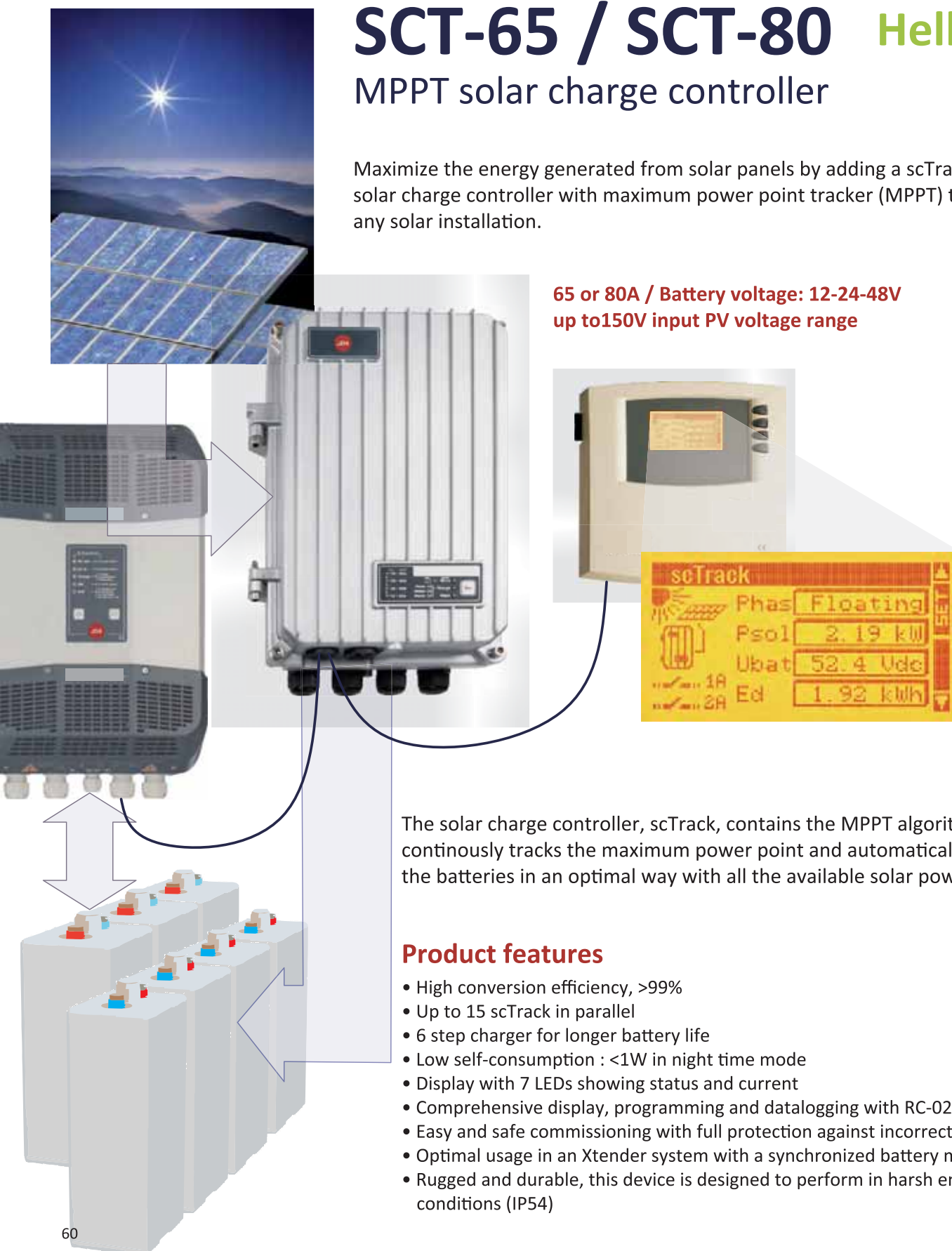

The solar charge controller, scTrack, contains the MPPT algorithm that continuously tracks the maximum power point and automatically charges the batteries in an optimal way with all the available solar power.

### Product features

- High conversion efficiency, >99%
- Up to 15 scTrack in parallel
- 6 step charger for longer battery life
- Low self-consumption : <1W in night time mode
- Display with 7 LEDs showing status and current
- Comprehensive display, programming and datalogging with RC-02/-03
- Easy and safe commissioning with full protection against incorrect wiring
- Optimal usage in an Xtender system with a synchronized battery management
- Rugged and durable, this device is designed to perform in harsh environmental conditions (IP54)



**HelliStar®**



**SCT-65 / SCT-80**

Electrical characteristics PV array side	SCT-65			SCT-80		
	12 V	24 V	48 V	12 V	24 V	48 V
At nominal battery voltage	12 V	24 V	48 V	12 V	24 V	48 V
Maximum Solar power recommended (@STC)	1000 W	2000 W	4000 W	1250 W	2500 W	5000 W
Maximum Solar Open Circuit Voltage	80 Vdc	150 Vdc	150 Vdc	80 Vdc	150 Vdc	150 Vdc
Maximum Solar functional circuit voltage	75 Vdc	145 Vdc	145 Vdc	75 Vdc	145 Vdc	145 Vdc
Minimum Solar functional circuit voltage	above battery voltage					
<b>Electrical characteristics Battery side</b>						
Maximum Output Current	65 A			80 A		
Nominal Battery Voltages	automatic / manual set to 12, 24 or 48 Vdc					
Operating voltage range	above battery voltage, minimum 7 V					
<b>Performances of the device</b>						
Power Conversion Efficiency (in a 48 V typical-system)	>99 %					
Maximum Stand-By Self-consumption (48 V)	25 mA > 1.2 W					
Maximum Stand-By Self-consumption (24 V)	30 mA > 0.8 W					
Maximum Stand-By Self-consumption (12 V)	35 mA > 0.5 W					
Charging stages	6 stages : Bulk, Absorption, Floating, Equalization, reduced floating, periodic absorption					
Battery temperature compensation (available with accessory BTS-01)	-3 mV /°C /cell (25°C ref) default value adjustable -8 to 0 mV /°C					
<b>Electronic protections</b>						
PV reverse polarity	up to -150 Vdc					
Battery reverse polarity	up to -150 Vdc					
Battery overvoltage	up to 150 Vdc					
Over temperature	protected					
Reverse current at night	prevented by relays					
<b>Environment</b>						
Operating Ambient Temperature Range	-20 to 55°C					
Humidity	100 %					
Ingress Protection of enclosures	IP54, IEC/EN 60529:2001					
Mounting location	indoor					
<b>General data</b>						
Warranty	5 years					
Weight	5.2 kg			5.5 kg		
Dimensions h/w/l [mm]	120 / 220 / 310			120 / 220 / 350		
Parallel operation (separated PV arrays)	up to 15 devices					
Max wire size	35 mm <sup>2</sup>					
Glands	M 20 x 1,5					
<b>Communication</b>						
Network Cabling	JDA communication BUS					
Remote Display and Controller	RC-02/RC-03/Jcom-232i					
Menu languages	English / French / German / Spanish					
Data Logging	With RC-02/RC-03 on SD card . One point every minute					
<b>Accordance to standards</b>						
CE compliant	EMC 2004/108/CE · LV 2006/95/CE · RoHS 2002/95/CE					
Safety	IEC/EN 62109-1:2010					
EMC (Electro Magnetic Compatibility)	IEC/EN 61000-6-3:2011 · IEC/EN 61000-6-1:2005					

Accessories (optional):



**RC-02**  
Remote control and programming center (Wall mounted)



**RC-03**  
Remote control and programming center (Panel mounted)



**MR-03**  
Auxiliary relay module



**TS-04**  
Battery temperature sensor



日燭科技有限公司  
JD Auspice Co., Ltd.

