

STATIONARY MODULAR RACK BATTERIES

GeI TECHNOLOGY

15 YEARS DESIGN LIFE IN FLOAT SERVICE



**HORIZONTAL LAYOUT MINIMISES
BATTERY FLOOR SPACE**

**Sealed Valve Regulated
Maintenance Free
Lead Acid Batteries**

**CAPACITY 100 Ah. TO 3000 Ah.
C/10 RATE TO 1.80 Vpc @ 20C
or C/8 to 1.75 Vpc @ 25C**

CADMIUM FREE

**FULLY RECYCLABLE
LEAD ACID BATTERIES**

**CONFORMS TO THE EUROPEAN
E.C.1992 DIRECTIVE ON
DANGEROUS SUBSTANCES**

INNOVATIVE FEATURES

- * Valve regulated with Catalyst
- * Fully tank formed plates
- * Never requires watering
- * Spill proof and leak proof
- * Low gassing on float charge
- * Explosion proof
- * Operates at low internal pressure
- * Increased safety
- * For use in vertical or horizontal position
- * Increased capacity in given area

APPLICATIONS

- * Photovoltaic / Solar
- * Telecommunications
- * UPS
- * Emergency Lighting
- * Standby Power
- * Switchgear
- * Control System
- * Cellular Radio
- * Navigation Aids

CELLYTE 2TLGM Modular - Ampere Hour Data TO 1.80 vpc @ 20 C.

SEC Battery TYPE	END Volts / Cell	DATA AMPS @ 20 C						END Volts / Cell	DISCHARGE DATA AMPS HOURS TO 1.80 vpc @ 20 C												
		DISCHARGE TIME IN MINUTES							DISCHARGE TIME IN HOURS												
		5	10	15	20	30	45		1	1.5	2	3	4	5	6	8	10	12	24	48	100
2TLGM100	1.75	147	128	116	105	86.6	70.2	1.80	54.2	60.4	66.1	74.0	80.7	85.1	89.4	100	102	103	111	113	122
2TLGM150	1.75	220	192	173	157	130	105	1.80	81.3	90.6	99.1	111	121	128	134	151	154	155	167	170	182
2TLGM200	1.75	293	256	231	210	173	140	1.80	108	121	132	148	161	170	179	201	205	207	223	227	243
2TLGM250	1.75	368	319	289	262	216	175	1.80	136	151	165	185	202	213	223	251	256	259	279	284	304
2TLGM300	1.75	440	383	347	314	260	211	1.80	163	181	198	222	242	255	268	301	307	310	334	340	365
2TLGM350	1.75	513	447	405	367	303	246	1.80	190	211	231	259	282	298	313	352	359	362	390	397	425
2TLGM400	1.75	586	511	462	419	346	281	1.80	217	242	264	296	323	340	357	402	410	414	446	454	486
2TLGM450	1.75	660	575	520	471	390	316	1.80	244	272	297	333	363	383	402	452	461	465	502	511	547
2TLGM500	1.75	733	639	578	524	433	351	1.80	271	302	330	370	403	425	447	502	512	517	557	567	608
2TLGM550	1.75	806	703	636	576	476	386	1.80	298	332	363	407	444	468	492	552	563	569	613	624	668
2TLGM600	1.75	879	767	694	629	520	421	1.80	325	362	396	444	484	510	536	603	615	621	669	681	729
2TLGM650	1.75	953	831	751	681	563	466	1.80	352	393	429	481	524	553	581	653	666	672	726	738	790
2TLGM700	1.75	1026	894	809	733	606	491	1.80	380	423	462	518	565	595	626	703	717	724	780	794	851
2TLGM750	1.75	1099	958	867	786	649	526	1.80	407	453	496	555	605	638	670	753	768	776	836	851	911
2TLGM800	1.75	1172	1022	925	838	693	561	1.80	434	483	529	592	645	680	715	803	820	828	892	908	972
2TLGM850	1.75	1246	1086	983	890	736	597	1.80	461	513	562	629	686	723	760	854	871	879	948	965	1033
2TLGM900	1.75	1319	1150	1040	943	779	632	1.80	488	544	595	666	726	765	804	904	922	931	1003	1021	1094
2TLGM1000	1.75	1466	1278	1156	1048	866	702	1.80	542	604	661	740	807	851	894	1004	1024	1034	1115	1135	1215
2TLGM1100	1.75	1612	1405	1272	1152	953	772	1.80	596	664	727	814	887	936	983	1105	1127	1138	1226	1248	1337
2TLGM1200	1.75	1759	1533	1387	1257	1039	842	1.80	651	725	793	898	968	1021	1072	1205	1229	1241	1338	1362	1458
2TLGM1300	1.75	1905	1661	1503	1362	1126	912	1.80	705	785	859	962	1049	1106	1162	1306	1332	1345	1449	1475	1580
2TLGM1400	1.75	2052	1789	1618	1467	1212	983	1.80	759	845	925	1036	1130	1191	1251	1406	1434	1448	1561	1589	1701
2TLGM1500	1.75	2198	1917	1734	1571	1299	1053	1.80	813	906	991	1110	1210	1276	1341	1506	1537	1552	1672	1702	1823
2TLGM1600	1.75	2345	2044	1850	1676	1385	1123	1.80	868	966	1057	1184	1291	1361	1430	1607	1639	1655	1784	1816	1944
2TLGM1700	1.75	2492	2172	1965	1781	1472	1193	1.80	922	1027	1123	1258	1372	1446	1519	1707	1741	1759	1895	1929	2066
2TLGM1800	1.75	2638	2300	2081	1898	1559	1263	1.80	976	1087	1189	1332	1452	1531	1609	1808	1844	1862	2007	2043	2187
2TLGM2000	1.75	2931	2555	2312	2095	1732	1404	1.80	1085	1208	1321	1480	1614	1701	1787	2009	2049	2069	2230	2270	2430
2TLGM2100	1.75	3078	2683	2428	2200	1818	1474	1.80	1139	1268	1387	1554	1694	1786	1877	2109	2151	2172	2341	2383	2552
2TLGM2250	1.75	3298	2875	2601	2357	1948	1579	1.80	1220	1359	1487	1665	1815	1914	2011	2260	2305	2327	2508	2553	2734
2TLGM2400	1.75	3517	3068	2775	2514	2078	1684	1.80	1301	1449	1586	1776	1936	2041	2145	2410	2459	2483	2675	2724	2916
2TLGM2550	1.75	3737	3258	2948	2671	2208	1790	1.80	1383	1540	1685	1887	2057	2169	2279	2561	2612	2638	2843	2894	3099
2TLGM2700	1.75	3957	3450	3121	2828	2338	1895	1.80	1464	1631	1784	1998	2178	2296	2413	2712	2766	2793	3010	3064	3281
2TLGM3000	1.75	4397	3833	3468	3143	2598	2105	1.80	1627	1812	1982	2220	2420	2552	2681	3013	3073	3103	3344	3405	3646

Actual discharge data may be +/- 5% of data shown - Single cells over 1400 Ah, not available until 2009

CELLYTE 2TLGM Modular free standing 2 volt cells - Gel Technology - with Catalyst.
 Valve Regulated Lead Acid (VRLA) low Maintenance Batteries - for Standby Applications.
 These are free standing cells and can be supplied as cells only or with Modular zone 4 racks
 or in vertical or horizontal conventional zone 0 Tubular racks.

"SEC-CAT" Catvent™ - Catalyst Vent Plug

SEC's VRLA cells incorporate the Philadelphia Scientific Precious Metal Catalyst **Catvent™**
 to stabilise the negative plate, enhance the water recombination process within the cell,
 reduce cell dry out, reduces float current by up to 50%, positive plate corrosion, thermal
 runaway, and capacity loss due to negativeplate polarisation.

This makes the **CELLYTE 2TLGM** battery ideally suited for Telecom, UPS, Photovoltaic, Wind
 power, and other Float & Shallow Cyclic applications. Manufactured to Quality system certified
 to ISO 9001

Applicable Standards

- IEC 60896-21/22-2004
- BS 6290 Part 4
- Eurobat
- UL Component approval

CELLYTE 2TLGM - Modular & Tubular Dims, Weights & Data

SEC Battery TYPE	Capacity C/10 1.00 vpc	CELL DIMENSIONS & WEIGHT					24 CELL BATTERY DIMENSIONS				Internal Resist. m Ohms	1 Minute Rate to 1.67 vpc	Short Circuit Current	No. of Terminal Post
		Length mm	Width mm	Height mm H1	Height mm H2	CELL KG	Length Mod/Tub	Depth mm	Height mm	Weight Mod/Tub				
		2TLGM100	100	102	187	278	300	7.0	672/720	310				
2TLGM150	150	102	187	278	300	10	672/720	310	1010	288/270	0.600	300	1500	2
2TLGM200	200	102	187	278	300	15	672/720	310	1010	430/400	0.500	340	1600	2
2TLGM250	250	102	187	374	396	17	672/720	410	1010	490/460	0.450	380	1900	2
2TLGM300	300	102	187	374	396	21	672/720	410	1010	605/565	0.400	480	2400	2
2TLGM350	350	151	187	435	465	25	966/1010	480	1010	720/670	0.390	580	2900	2
2TLGM400	400	151	187	435	465	28	966/1010	480	1010	810/750	0.360	640	3200	2
2TLGM420	420	151	187	435	465	29	966/1010	480	1010	810/750	0.350	660	3300	2
2TLGM450	450	151	187	435	465	32	966/1010	480	1010	920/860	0.330	720	3600	2
2TLGM500	500	151	187	543	565	34	966/1010	580	1010	980/910	0.300	800	4000	2
2TLGM550	550	151	187	543	565	36	966/1010	580	1010	1040/970	0.290	900	4500	2
2TLGM600	600	151	187	543	565	38	966/1010	580	1010	1100/1000	0.280	970	4800	2
2TLGM650	650	151	187	543	565	41	966/1010	580	1010	1180/1080	0.240	1030	5100	2
2TLGM700	700	151	187	543	565	45	966/1010	580	1010	1300/1190	0.230	1120	5600	2
2TLGM750	750	223	187	543	565	48	958/980	580	1400	1390/1270	0.220	1200	6000	4
2TLGM800	800	223	187	543	565	58	958/980	580	1400	1670/1530	0.200	1280	6400	4
2TLGM850	850	223	187	543	565	61	958/980	580	1400	1750/1600	0.190	1380	6900	4
2TLGM900	900	223	187	543	565	65	958/980	580	1400	1870/1710	0.180	1460	7300	4
2TLGM1000	1000	223	187	543	565	68	958/980	580	1400	1950/1800	0.160	1580	7900	4
2TLGM1100	1100	2 x 151	187	543	565	2 x 36	1916/1940	580	1400	2130/1950	0.145	1800	9000	8
2TLGM1200	1200	2 x 151	187	643	565	2 x 38	1916/1940	580	1400	2250/2060	0.150	1940	9600	8
2TLGM1300	1300	2 x 151	187	643	565	2 x 41	1916/1940	580	1400	2360/2160	0.120	2060	10200	8
2TLGM1400	1400	2 x 151	187	643	565	2 x 45	1916/1940	580	1400	2530/2320	0.115	2240	11200	8
2TLGM1500	1500	2 x 223	187	643	565	2 x 48	1916/1940	580	1400	2770/2530	0.110	2400	12000	8
2TLGM1600	1600	2 x 223	187	543	565	2 x 58	1916/1940	580	1400	3340/3060	0.100	2560	12800	8
2TLGM1700	1700	2 x 223	187	543	565	2 x 61	1916/1940	580	1400	3510/3220	0.095	2760	13800	8
2TLGM1800	1800	2 x 223	187	543	565	2 x 65	1916/1940	580	1400	3750/3430	0.090	2920	14600	8
2TLGM2000	2000	2 x 223	187	543	565	2 x 68	1916/1940	580	1400	3920/3590	0.080	3160	15800	8
2TLGM2100	2100	3 x 151	187	543	565	3 x 45	2916/2940	580	1400	4260/3900	0.070	3360	16800	12
2TLGM2250	2250	3 x 223	187	543	565	3 x 48	2916/2940	580	1400	4490/4120	0.065	3600	18000	12
2TLGM2400	2400	3 x 223	187	543	565	3 x 58	2916/2940	580	1400	4720/4330	0.063	3840	19200	12
2TLGM2550	2550	3 x 223	187	543	565	3 x 61	2916/2940	580	1400	4720/4330	0.063	4140	20700	12
2TLGM2700	2700	3 x 223	187	543	565	3 x 65	2916/2940	580	1400	5970/4640	0.060	4380	21900	12
2TLGM3000	3000	3 x 223	187	543	565	3 x 68	2916/2940	580	1400	5530/5070	0.055	4740	23700	12

Actual discharge data may be +/- 5% of data shown - Single cells over 1400 ah not available until 2009

Typical Modular Zone 4 Racks for 48 Volt Systems

Note:- Cells 1500Ah. to 2800Ah. are currently made up of 2 x 750Ah. to 2 x 1400Ah. and cell 3000Ah. made up of 3 x 1000Ah. connected in parallel or series

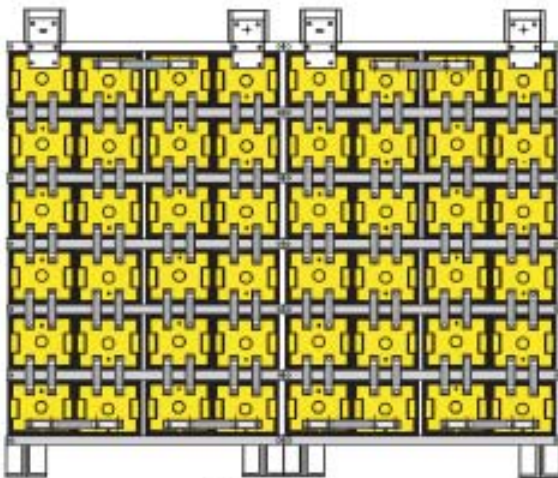

Front view
24 x 2TLAM1500 to 2800
(2 x 24 x 750 to 1400)
2 x 4 post cells

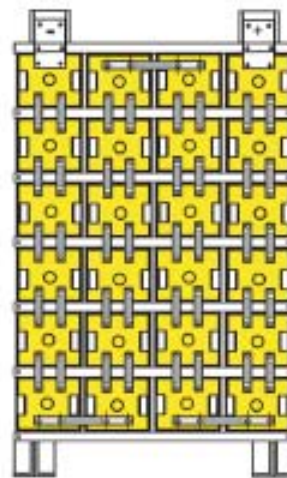

Front view
24 x 2TLAM750 to 1400
4 post cells

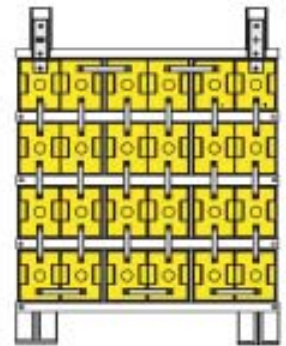

Front view
24 x 2TLAM100 to 700
2 post cells

CELLYTE 2TLGM Modular - Amps Data TO 1.80 vpc @ 20 C.

SEC Battery TYPE	END Volts / Cell	DATA AMPS @ 20 C						END Volts / Cell	DISCHARGE DATA AMPS TO 1.80 vpc @ 20 C												
		DISCHARGE TIME IN MINUTES							DISCHARGE TIME IN HOURS												
		5	10	15	20	30	45		1	1.5	2	3	4	5	6	8	10	12	24	48	100
2TLGM100	1.75	147	128	116	105	86.6	70.2	1.80	54.2	40.3	33.0	24.7	20.2	17.0	14.9	12.6	10.2	8.62	4.64	2.36	1.22
2TLGM150	1.75	220	192	173	157	130	105	1.80	81.3	60.4	49.6	37.0	30.3	25.5	22.3	18.8	15.4	12.9	6.97	3.55	1.82
2TLGM200	1.75	293	256	231	210	173	140	1.80	108	80.5	66.1	49.3	40.3	34.0	29.8	25.1	20.5	17.2	9.29	4.73	2.43
2TLGM250	1.75	366	319	289	262	216	175	1.80	136	101	82.6	61.7	50.4	42.5	37.2	31.4	25.6	21.6	11.6	5.91	3.04
2TLGM300	1.75	440	383	347	314	260	211	1.80	163	121	99.1	74.0	60.5	51.0	44.7	37.7	30.7	25.9	13.9	7.09	3.65
2TLGM350	1.75	513	447	405	367	303	246	1.80	190	141	116	86.3	70.6	59.5	52.1	43.9	35.9	30.2	16.3	8.27	4.25
2TLGM400	1.75	586	511	462	419	346	281	1.80	217	161	132	98.7	80.7	68.0	59.6	50.2	41.0	34.5	18.6	9.46	4.86
2TLGM450	1.75	660	575	520	471	390	316	1.80	244	181	149	111	90.8	76.5	67.0	56.5	46.1	38.8	20.9	10.6	5.47
2TLGM500	1.75	733	639	578	524	433	351	1.80	271	201	165	123	100.9	85.1	74.5	62.8	51.2	43.1	23.2	11.8	6.08
2TLGM550	1.75	806	703	636	576	476	386	1.80	298	221	182	136	111	93.6	81.9	69.0	56.3	47.4	25.5	13.0	6.68
2TLGM600	1.75	879	767	694	629	520	421	1.80	325	242	198	148	121	102	89.4	75.3	61.5	51.7	27.9	14.2	7.29
2TLGM650	1.75	953	831	751	681	563	456	1.80	352	262	215	160	131	111	96.8	81.6	66.6	56.0	30.2	15.4	7.90
2TLGM700	1.75	1026	894	809	733	606	491	1.80	380	282	231	173	141	119	104	87.9	71.7	60.3	32.5	16.5	8.51
2TLGM750	1.75	1099	958	867	786	649	526	1.80	407	302	248	185	151	128	112	94.2	76.8	64.7	34.8	17.7	9.11
2TLGM800	1.75	1172	1022	925	838	693	561	1.80	434	322	264	197	161	136	119	100.4	82.0	69.0	37.2	18.9	9.72
2TLGM850	1.75	1246	1086	983	890	736	597	1.80	461	342	281	210	171	145	127	107	87.1	73.3	39.5	20.1	10.3
2TLGM900	1.75	1319	1150	1040	943	779	632	1.80	488	362	297	222	182	153	134	113	92.2	77.6	41.8	21.3	10.9
2TLGM1000	1.75	1466	1278	1156	1048	866	702	1.80	542	403	330	247	202	170	149	126	102	86.2	46.4	23.6	12.2
2TLGM1100	1.75	1612	1405	1272	1152	953	772	1.80	596	443	363	271	222	187	164	138	113	94.8	51.1	26.0	13.4
2TLGM1200	1.75	1759	1533	1387	1257	1039	842	1.80	651	483	396	296	242	204	179	151	123	103	55.7	28.4	14.6
2TLGM1300	1.75	1905	1661	1503	1362	1126	912	1.80	705	523	429	321	262	221	194	163	133	112	60.4	30.7	15.8
2TLGM1400	1.75	2052	1789	1618	1467	1212	983	1.80	759	564	462	345	282	238	209	176	143	121	65.0	33.1	17.0
2TLGM1500	1.75	2198	1917	1734	1571	1299	1053	1.80	813	604	496	370	303	255	223	188	154	129	69.7	35.5	18.2
2TLGM1600	1.75	2345	2044	1850	1676	1385	1123	1.80	868	644	529	395	323	272	238	201	164	138	74.3	37.8	19.4
2TLGM1700	1.75	2492	2172	1965	1781	1472	1193	1.80	922	684	562	419	343	289	253	213	174	147	79.0	40.2	20.7
2TLGM1800	1.75	2638	2300	2081	1886	1559	1263	1.80	976	725	595	444	363	306	268	226	184	155	83.6	42.6	21.9
2TLGM2000	1.75	2931	2555	2312	2095	1732	1404	1.80	1085	805	661	493	403	340	298	251	205	172	92.9	47.3	24.3
2TLGM2100	1.75	3078	2683	2428	2200	1818	1474	1.80	1139	845	694	518	424	357	313	264	215	181	98	49.6	25.5
2TLGM2250	1.75	3298	2875	2601	2357	1948	1579	1.80	1220	906	743	555	454	383	335	282	230	194	105	53.2	27.3
2TLGM2400	1.75	3517	3066	2775	2514	2078	1684	1.80	1301	966	793	592	484	408	357	301	246	207	111	56.7	29.2
2TLGM2550	1.75	3737	3258	2948	2671	2208	1790	1.80	1383	1027	842	629	514	434	380	320	261	220	118	60.3	31.0
2TLGM2700	1.75	3957	3450	3121	2828	2338	1895	1.80	1464	1087	892	666	545	459	402	339	277	233	125	63.8	32.8
2TLGM3000	1.75	4397	3833	3468	3143	2598	2105	1.80	1627	1208	991	740	605	510	447	377	307	259	139	70.9	36.5

Actual discharge data may be +/- 5% of data shown - Single cells over 1400 Ah, not available until 2009

Typical Tubular Zone 0 racks for 48Volt System

Note:- Cells 1500Ah. to 2800Ah. are currently made up of 2 x 750Ah. to 2 x 1400Ah. and cell 3000Ah. made up of 3 x 1000Ah. connected in parallel or series

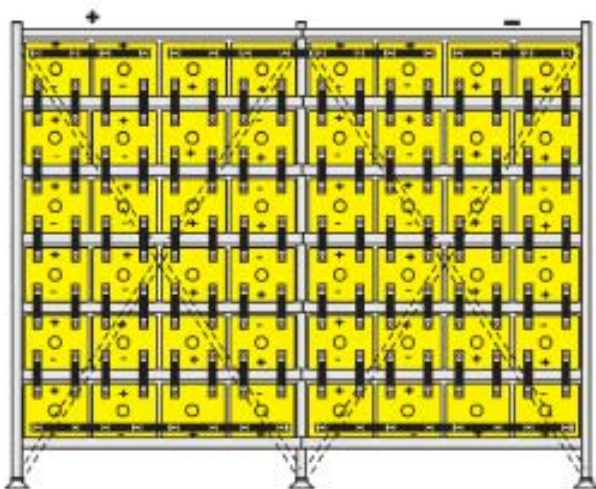

Front view
24 x 2TLAM1500 to 2800
(2 x 24 x 750 to 1400)
2 x 4 post cells

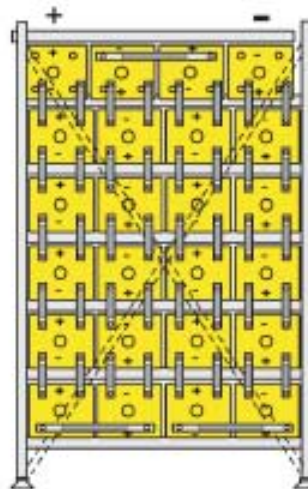

Front view
24 x 2TLAM750 to 1400
4 post cells

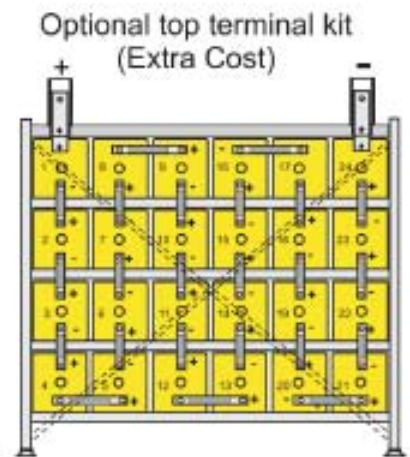

Front view
24 x 2TLAM100 to 700
2 post cells

CELLYTE 2TLGM Modular/Tubular - Watts to 1.67 / 1.75 vpc @ 20 C.

SEC Battery TYPE	END Volts / Cell	DISCHARGE Watts per Cell at 20 C						END Volts / Cell	DISCHARGE DATA Watts Per Cell AT 20 C									
		DISCHARGE TIME IN MINUTES							DISCHARGE TIME IN HOURS									
		5	10	15	20	30	45		1	1.5	2	3	4	5	6	8	10	
2TLGM100	1.67	259	242	231	209	165	130	1.75	109	79.4	65.4	50.0	41.0	34.4	29.8	24.2	20.2	
2TLGM150	1.67	387	363	346	314	248	196	1.75	166	119	97.1	74.2	60.8	51.0	44.2	35.9	29.7	
2TLGM200	1.67	517	484	462	418	331	261	1.75	221	158	130	98.9	81.1	68.0	59.0	47.9	39.6	
2TLGM250	1.67	646	604	577	523	414	326	1.75	276	198	162	124	101	85.0	73.7	59.9	49.5	
2TLGM300	1.67	775	725	692	628	496	391	1.75	331	237	194	148	122	102	88.5	71.9	59.4	
2TLGM350	1.67	904	846	808	732	579	457	1.75	387	277	227	173	142	119	103	83.8	69.3	
2TLGM400	1.67	1033	967	923	837	662	522	1.75	442	316	259	198	162	136	118	95.8	79.1	
2TLGM450	1.67	1162	1088	1038	941	744	587	1.75	497	356	291	223	182	153	133	108	89.0	
2TLGM500	1.67	1291	1209	1154	1046	827	652	1.75	552	395	324	247	203	170	147	120	98.9	
2TLGM550	1.67	1420	1330	1269	1150	910	717	1.75	607	435	356	272	223	187	162	132	109	
2TLGM600	1.67	1550	1451	1385	1255	993	783	1.75	663	474	389	297	243	204	177	144	119	
2TLGM650	1.67	1679	1571	1500	1360	1075	848	1.75	718	514	421	321	263	221	192	156	129	
2TLGM700	1.67	1808	1692	1615	1464	1158	913	1.75	773	553	453	346	284	238	206	168	139	
2TLGM750	1.67	1937	1813	1731	1569	1241	978	1.75	828	593	486	371	304	255	221	180	148	
2TLGM800	1.67	2066	1934	1846	1673	1323	1044	1.75	884	632	518	396	324	272	236	192	158	
2TLGM850	1.67	2195	2055	1962	1778	1406	1109	1.75	939	672	550	420	344	289	251	204	168	
2TLGM900	1.67	2324	2176	2077	1883	1489	1174	1.75	994	711	583	445	365	306	265	216	178	
2TLGM1000	1.67	2583	2418	2308	2092	1654	1305	1.75	1105	790	648	494	405	340	295	240	198	
2TLGM1100	1.67	2841	2659	2539	2301	1820	1435	1.75	1215	869	712	544	446	374	324	263	218	
2TLGM1200	1.67	3099	2901	2769	2510	1985	1565	1.75	1325	948	777	593	486	408	354	287	237	
2TLGM1300	1.67	3358	3143	3000	2719	2151	1696	1.75	1436	1027	842	643	527	442	383	311	257	
2TLGM1400	1.67	3616	3385	3231	2928	2316	1826	1.75	1546	1106	907	692	567	476	413	335	277	
2TLGM1500	1.67	3874	3627	3462	3138	2482	1957	1.75	1657	1185	971	742	608	510	442	359	297	
2TLGM1600	1.67	4132	3868	3692	3347	2647	2087	1.75	1767	1264	1038	791	648	544	472	383	317	
2TLGM1700	1.67	4391	4110	3923	3556	2812	2218	1.75	1878	1343	1101	841	689	578	501	407	336	
2TLGM1800	1.67	4649	4352	4154	3765	2978	2348	1.75	1988	1422	1166	890	729	612	531	431	356	
2TLGM2000	1.67	5165	4835	4616	4183	3309	2609	1.75	2209	1580	1295	989	811	680	590	479	396	
2TLGM2100	1.67	5424	5077	4846	4393	3474	2740	1.75	2320	1659	1360	1038	851	714	619	503	416	
2TLGM2250	1.67	5811	5440	5192	4706	3722	2935	1.75	2485	1778	1457	1113	912	765	664	539	445	
2TLGM2400	1.67	6199	5802	5539	5020	3970	3131	1.75	2651	1896	1554	1187	973	816	708	575	475	
2TLGM2550	1.67	6586	6185	5885	5334	4219	3327	1.75	2817	2015	1651	1261	1033	867	752	611	505	
2TLGM2700	1.67	6973	6528	6231	5648	4467	3522	1.75	2982	2133	1748	1335	1094	918	796	647	534	
2TLGM3000	1.67	7748	7253	6923	6275	4963	3914	1.75	3314	2370	1943	1483	1216	1020	885	719	594	

Actual discharge data may be +/- 5% of data shown - Single cells over 1400 Ah. not available until 2009

Features:

The **CELLYTE 2TLGM** 'High Integrity' high density battery is supplied as a free standing 2 volt vertical or horizontal cell or in a modular or tubular steel racking system for minimum floor space, uniform cell cooling and extra long life. The Zone 4 modular battery rack design provides a stronger battery rack that is reduced in both height, width and weight. The Zone 0 tubular battery racks for areas not subject to earthquakes.

System Configuration:

24 and 48 volts for Telecommunications

120, 240 and 480 volts for UPS, Power and Switchgear Control

Zone 4 rated modules with horizontal cell layout provides smaller battery foot print

Zone 0 rated tubular racks with vertical or horizontal cell layout for minimum battery footprint.

SEC's **CELLYTE 2TLGM** batteries are manufactured using modern technology in a new joint venture battery manufacturing facility. SEC has been able to draw on a wealth of international experience and knowledge to produce high quality reliable lead acid batteries. The continuing installation of modern production equipment makes continuous product improvement possible.

Endurance in cycles according to IEC 896-2

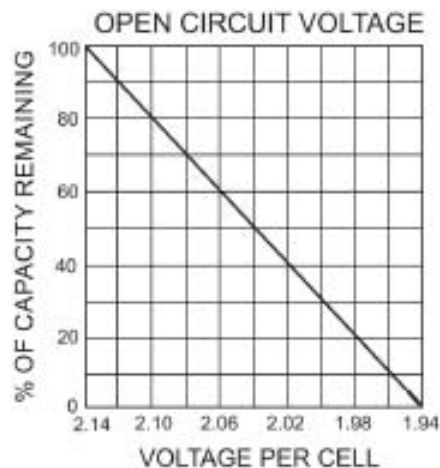
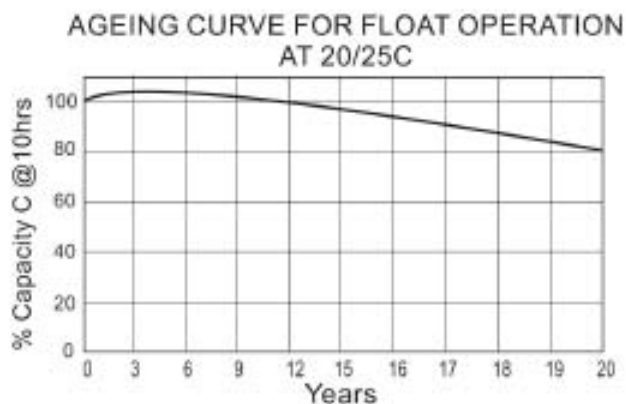
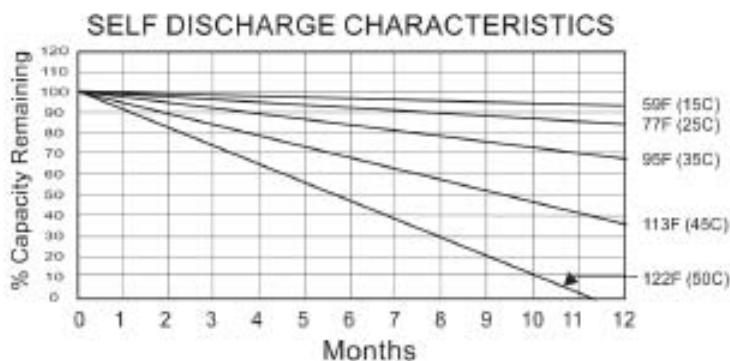
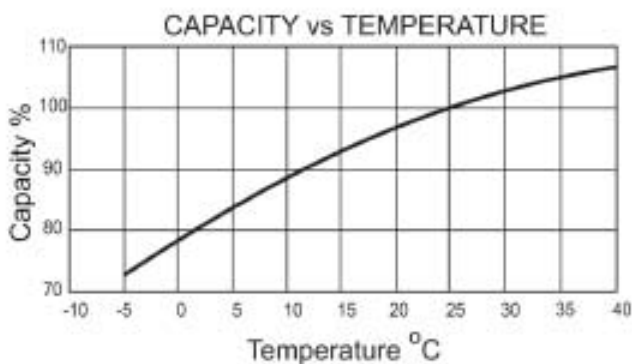
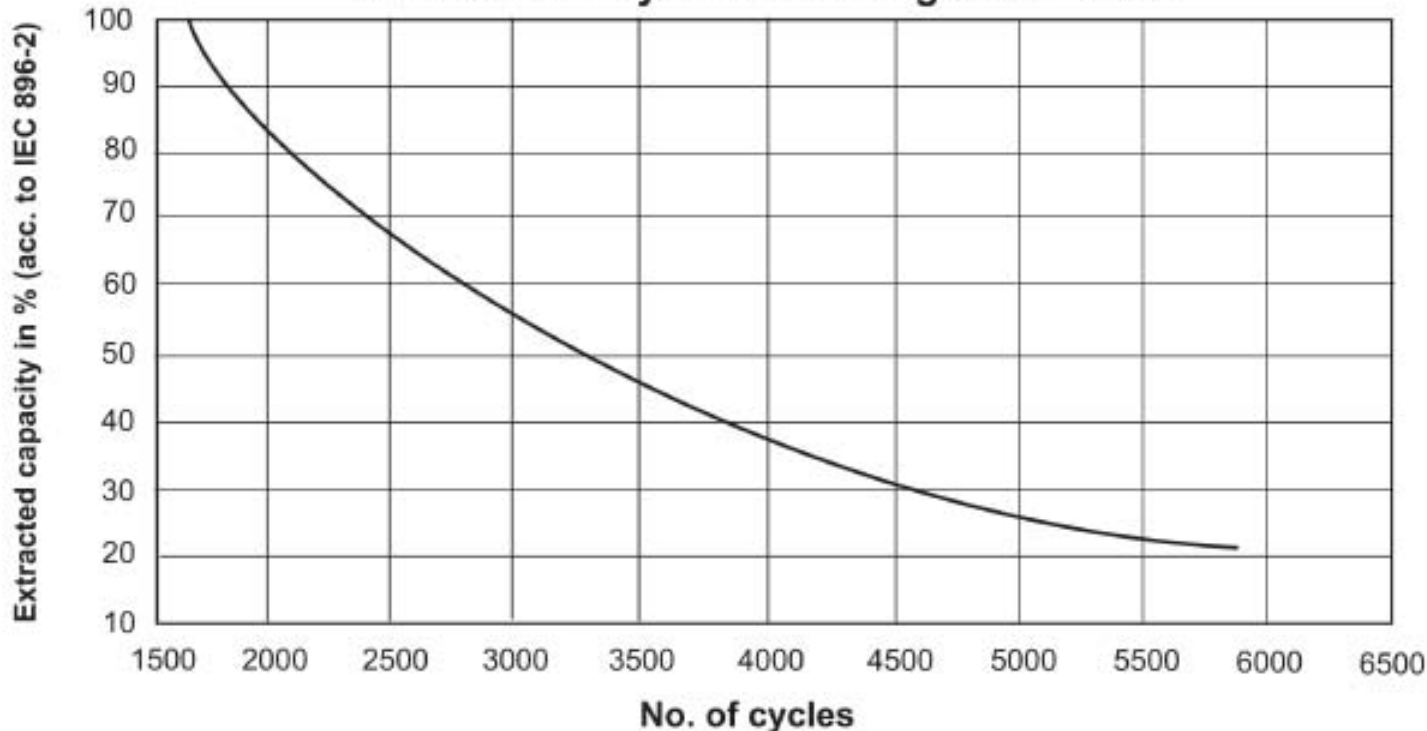

CELLYTE 2TLGM Cell - Cutaway View

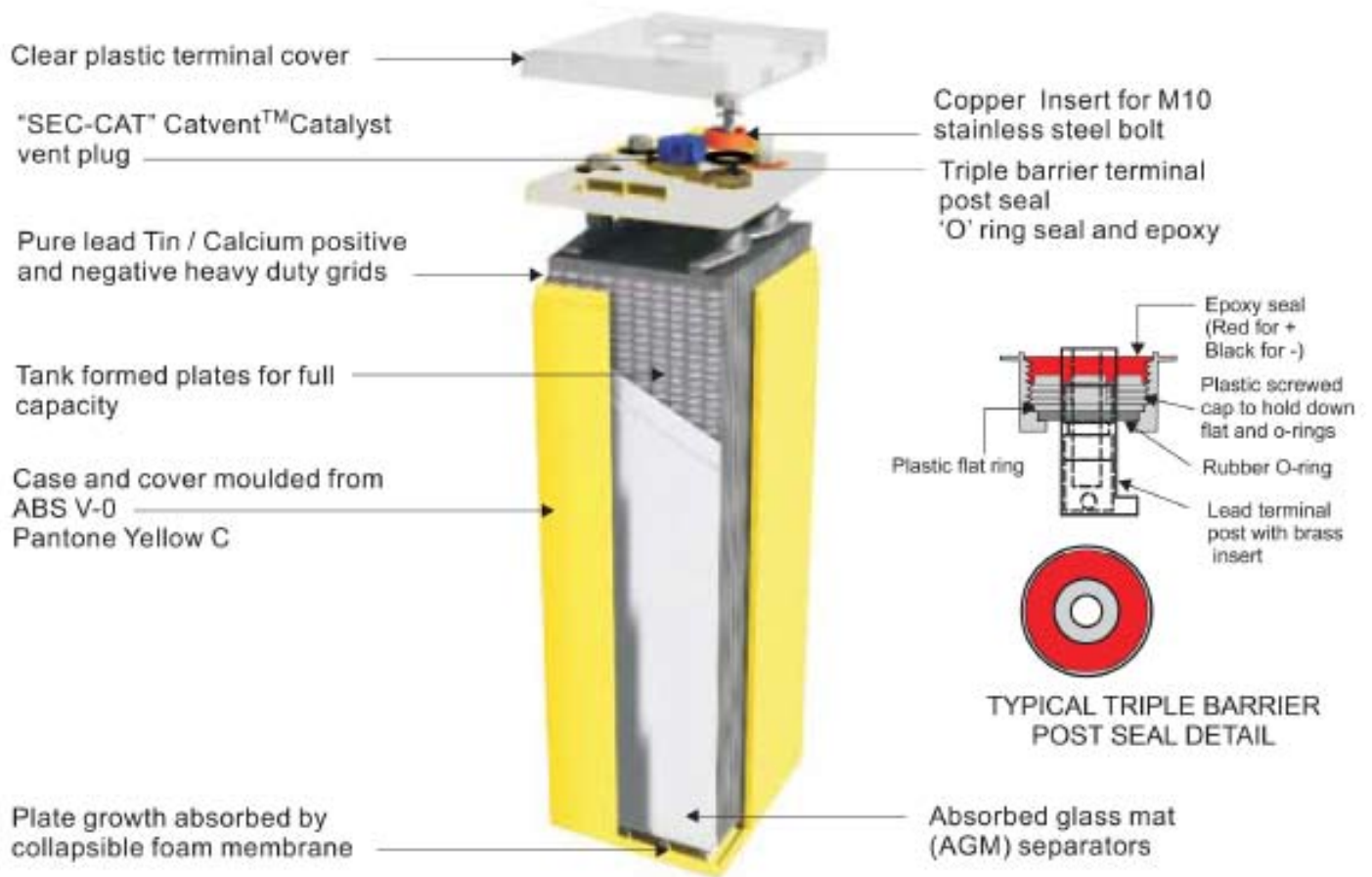

Heavy duty ABS cell jar can be free standing or in a zone 4 modular rack

Benefits of Catalyst in SEC VRLA Batteries

Catalyst Reduces Float Current

One of the most immediate, observable effects of installing a catalyst in a VRLA cell is a sudden drop in the float current. Typically float currents are one half or less when a catalyst is installed. Adding a catalyst to the cell prevents some of the oxygen reaching the negative plate and allows the negative plate to stay polarised. This means that less current needs to be supplied to the cell from the charging system, manifesting itself as lower float current, leading to the following benefit :-

* Minimize water loss

Gasses are recombined into water inside the cell rather than exiting the cell. Too much gas leaving the cell can lead to premature dry-out and cell failure. Cell dry is a major cause of VRLA cell failure

* Increased life

There are many potential failure modes of VRLA cells. A number of these failure modes can be mitigated by the catalyst technology such as: Cell dry out, positive plate corrosion, thermal runaway, capacity loss due to negative plate depolarization

* Minimize positive plate corrosion

A reduction in float current reduces the amount of over-charge on the positive plate which directly impacts the corrosion rate. The design life of a lead acid cell is based on the corrosion of the plate barring any other unforeseen failure modes.

* Maintain cell capacity

Many VRLA cells in service are failing capacity tests because their negative plates are depolarized. In fact significant capacity increases have been seen on some cells just by installing a catalyst.



CELLYTE 2CMT/G Modular



CELLYTE 2TLAM/G Tubular



CELLYTE 2CMT/G, 2TLAM/G with Catalyst



CELLYTE 12FTA/G Range



CELLYTE 6-12TLA Range



CELLYTE 6-12TUA Range



CELLYTE 6-12TLG Range



CELLYTE 6-12TSG Range



MICROLYTE +Plus Range



MICROLYTE Red Top Range



CELLYTE 2TLA/G Range



**SEC 2ETG OPzV Range
in Tubular Rack**



SEC Tubular OPzS Range



SEC Nickel Cadmium Range

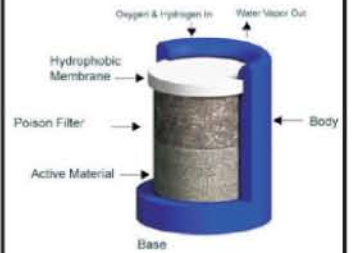

Typical VRLA Catalyst

Introduction

SEC batteries have been used in the industrial battery market for over 20 years. SEC's 2TLG high quality 2 volt cells, with 15 year design life, using gelled electrolyte technology cells have a proven record and we have extended our range of 2TLG cells to include smaller and larger sizes. These 2TLG cells are designed to comply with EUROBAT (draft 896-2), IEEE, JIS and BS 6290 Part 4, using UL certified components.

Valve regulated lead acid (VRLA) batteries are sealed, however, for safety reasons they are fitted with a one-way pressure release valve that opens when excess pressure builds up in the cell. The recombination of the gasses is accomplished by allowing the oxygen produced at the positive plate, to pass through the gelled electrolyte and separator material to the negative plate where the recombination reaction occurs. The one-way safety valve controls the internal pressure of the cell to optimise the efficiency of the recombination reaction and to minimize the loss of water in the form of hydrogen and oxygen gas.

SEC's **CELLYTE 2TLG** gelled electrolyte Gel Cells are manufactured in a new facility. SEC has drawn on a wealth of international experience and knowledge to produce high quality, long life, reliable lead acid batteries.

* **Valve Regulated Construction (Sealed)**

The SEC **CELLYTE** valve regulated lead acid battery is designed for safe, trouble free operation in vertical or horizontal position. The acid is immobilized in a specially formulated thixotropic gel electrolyte and it provides a safe non-spillable battery.

* **Gas Recombination System.**

The gasses generated in the normal charge/discharge use of the battery is recombined during normal operation. In normal operation more than 99% of the gases generated are efficiently recombined.

* **SEC-CAT Catvent™ Catalyst Vent Plug**

SEC's VRLA cells incorporate the Philadelphia Scientific precious metal catalyst **Catvent™** to enhance the water recombination process within the cell and reduce the float current by up to 50%, which in turn, reduces cell dry out, positive plate corrosion, thermal runaway, and capacity loss due to negative plate polarisation.

* **Maintenance.**

The Battery has been designed and built such that no addition of water is needed for the life of the battery thus there is no need to add water or take time-consuming specific gravity readings.

* **Battery Life - Float Service.**

The SEC **CELLYTE 2TLG** - 2 Volt cells designed for float/standby service with design life of 15 years at 20°C.

* **Battery Life Cycle Service.**

The SEC **CELLYTE 2TLG** 2 Volt cells are designed for more than 4000 charge/discharge cycles, actual quantity will depend on the depth of discharge.

* **Safety Valve.**

If excess pressure builds up within the battery, the safety valve automatically opens and re closes, releasing the gas at 1-3 p.s.i. The valve does not allow the ingress of oxygen, which is harmful, and reduces the life expectation of the battery.

* **Temperature Range for Normal Operation.**

The SEC **CELLYTE 2TLG** - 2 Volt cell range has a wide operating temperature range. However for maximum life and safety, continuous operation over 40 deg C is not recommended, in fact this is not recommended for any valve regulated battery.

* **Grid Design and Paste Formulation.**

SEC has optimized the grid design and paste formulation to maximize the operating and storage life of the cell/battery. This optimized design provides the following advantages: - excellent recovery from deep discharge or over discharge; low self discharge to ensure maximum storage time when not in use; excellent cycling capability; and good safety margins in tough operating conditions.

CELLYTE 2TLG -2 Volt Cell Ampere Hour Data @ 20 C.

SEC 2 Volt Cell TYPE	END Volts / CELL	DISCHARGE DATA AMPS @ 20 C					END Volts / CELL	DISCHARGE DATA AMPERE HOURS @ 20 C														
		DISCHARGE TIME IN MINUTES						DISCHARGE TIME IN HOURS														
		5	10	15	30	45		1	1.5	2	3	4	5	6	8	10	12	24	48	100		
2TLG 50	1.80	120	89.8	74.8	49.1	36.8	1.85	29.9	31.5	33.1	36.8	38.2	39.6	41.4	44.6	46.0	48.9	51.1	52.9	56.8		
	1.75	128	95.9	79.9	52.4	39.3	1.80	32.0	33.2	34.9	38.8	40.2	41.7	43.6	47.0	48.5	49.4	53.8	55.7	59.6		
	1.67	138	104	87.8	53.8	40.2	1.75	32.4	34.2	35.9	39.9	41.4	42.0	44.9	48.4	49.9	50.9	55.4	57.4	61.4		
2TLG 100	1.80	239	180	150	98.1	73.6	1.85	59.8	63.1	66.3	73.6	76.4	79.2	82.8	89.3	92.1	93.9	102	106	113		
	1.75	256	192	160	105	78.7	1.80	64.0	66.4	69.8	77.5	80.4	83.3	87.2	94.0	96.9	98.8	108	111	119		
	1.67	276	207	175	108	80.4	1.75	64.9	68.4	71.9	79.8	82.8	85.8	89.8	96.8	99.8	102	111	115	123		
2TLG 150	1.80	357	268	223	146	110	1.85	89.2	94.0	98.8	110	114	118	123	133	137	140	152	158	169		
	1.75	381	286	238	156	117	1.80	95.3	98.9	104	116	120	124	130	140	144	147	160	166	178		
	1.67	412	309	251	160	120	1.75	96.7	102	107	119	123	128	134	144	148	152	165	171	183		
2TLG 200	1.80	333	286	238	183	144	1.85	119	125	132	147	152	158	165	178	183	187	203	211	225		
	1.75	395	318	272	198	154	1.80	127	132	139	154	160	166	174	187	193	197	214	222	237		
	1.67	439	368	302	203	158	1.75	129	136	143	159	165	171	179	193	199	203	220	228	244		
2TLG 250	1.80	416	356	297	220	180	1.85	148	156	164	183	190	196	205	221	228	233	253	263	281		
	1.75	482	397	339	244	192	1.80	159	165	173	192	199	207	216	233	240	245	267	276	296		
	1.67	547	459	377	253	196	1.75	161	170	178	198	205	213	223	240	248	253	275	285	304		
2TLG 300	1.80	499	428	357	275	216	1.85	178	188	198	219	228	236	247	266	274	280	305	316	337		
	1.75	591	477	408	294	231	1.80	191	198	208	231	240	248	260	280	289	295	321	332	355		
	1.67	657	551	452	304	236	1.75	193	204	214	238	247	256	268	289	297	303	330	342	366		
2TLG 375	1.80	623	534	445	342	269	1.85	222	234	246	274	284	294	308	332	342	349	380	393	421		
	1.75	737	594	509	366	288	1.80	238	247	259	288	299	310	324	349	360	367	400	414	443		
	1.67	820	687	564	378	294	1.75	241	254	267	297	308	319	334	360	371	378	412	426	456		
2TLG 400	1.80	665	570	475	366	287	1.85	238	250	263	292	303	314	329	355	366	373	406	420	450		
	1.75	787	636	543	391	307	1.80	254	264	277	308	319	331	346	373	385	392	427	442	473		
	1.67	876	734	603	404	314	1.75	258	271	285	317	329	341	357	384	396	404	440	456	487		
2TLG 450	1.80	747	641	534	411	323	1.85	267	281	296	329	341	353	370	398	411	419	456	472	505		
	1.75	884	713	611	439	345	1.80	285	296	311	348	359	372	389	419	432	441	480	497	532		
	1.67	984	825	677	454	353	1.75	289	305	321	356	370	383	401	432	445	454	494	512	548		
2TLG 500	1.80	831	712	594	457	359	1.85	297	313	329	365	379	383	411	443	457	466	507	525	562		
	1.75	984	793	679	489	384	1.80	317	329	346	385	399	413	433	466	481	490	534	553	591		
	1.67	1094	917	753	505	393	1.75	322	339	356	396	411	426	446	480	495	505	550	569	608		
2TLG 550	1.80	944	810	675	519	408	1.85	337	355	374	415	431	446	467	503	519	529	576	597	638		
	1.75	1118	901	772	555	436	1.80	361	374	393	437	453	470	492	530	546	557	606	628	672		
	1.67	1243	1042	856	574	446	1.75	368	385	405	450	467	484	506	546	563	574	625	647	692		
2TLG 600	1.80	997	855	712	548	431	1.85	356	375	394	438	455	471	493	531	548	558	608	630	674		
	1.75	1180	951	814	586	461	1.80	381	395	415	461	479	496	519	559	577	588	640	663	709		
	1.67	1313	1100	903	606	471	1.75	386	407	428	475	493	511	535	576	594	606	659	683	731		
2TLG 650	1.80	1081	926	772	594	467	1.85	386	407	428	475	493	511	534	576	594	606	659	683	730		
	1.75	1279	1031	883	635	499	1.80	413	428	450	500	519	538	563	606	625	638	694	719	769		
	1.67	1423	1193	979	657	511	1.75	419	441	464	515	534	554	579	625	644	657	715	740	792		
2TLG 750	1.80	1248	1070	892	687	539	1.85	460	484	509	568	587	608	636	688	707	707	707	707	707		
	1.75	1477	1191	1020	734	577	1.80	471	489	514	571	593	614	643	693	714	736	801	830	888		
	1.67	1643	1378	1131	759	600	1.75	483	509	535	595	617	640	669	721	744	759	825	856	915		
2TLG 800	1.80	1330	1140	950	732	575	1.85	475	501	526	585	607	629	658	709	731	746	811	841	899		
	1.75	1574	1270	1087	792	615	1.80	508	527	554	616	639	662	693	746	770	785	854	885	946		
	1.67	1752	1468	1206	809	629	1.75	515	543	571	634	658	682	713	769	793	808	880	911	975		
2TLG 1000	1.80	1659	1422	1185	912	717	1.85	592	624	656	729	757	784	820	884	912	930	1012	1048	1121		
	1.75	1963	1583	1355	975	766	1.80	633	657	691	768	796	825	864	931	960	979	1065	1103	1180		
	1.67	2184	1831	1503	1009	784	1.75	642	677	712	791	820	850	889	959	988	1008	1097	1137	1216		

Actual Battery Discharge Data may be +/-5% of figures shown.

Note: Largest single cell is 1000 ah

CELLYTE 2TLG -2 Volt Cell Amps Data @ 20 C.

SEC 2 Volt Cell TYPE	END Volts / CELL	DISCHARGE DATA AMPS @ 20 C					END Volts / CELL	DISCHARGE DATA AMPS @ 20 C												
		DISCHARGE TIME IN MINUTES						DISCHARGE TIME IN HOURS												
		5	10	15	30	45		1	1.5	2	3	4	5	6	8	10	12	24	48	100
2TLG 50	1.80	120	89.8	74.8	49.1	36.8	1.85	29.9	21.0	16.6	12.3	9.55	7.92	6.90	5.58	4.60	3.91	2.13	1.10	0.57
	1.75	126	96	79.9	52.4	39.3	1.80	32.0	22.1	17.4	12.9	10.1	8.33	7.27	5.67	4.65	4.12	2.24	1.16	0.60
	1.67	138	104	87.6	53.8	40.2	1.75	32.4	22.8	18.0	13.3	10.4	8.58	7.49	6.05	4.99	4.24	2.31	1.20	0.61
2TLG 100	1.80	239	180	150	98.1	73.6	1.85	59.8	42.0	33.1	24.5	19.1	15.8	13.8	11.2	9.21	7.82	4.26	2.21	1.13
	1.75	256	192	160	105	78.7	1.80	64.0	44.3	34.9	25.8	20.1	16.7	14.5	11.7	9.69	8.24	4.48	2.32	1.19
	1.67	276	207	175	108	80.4	1.75	64.9	45.6	35.9	26.6	20.7	17.2	15.0	12.1	9.98	8.48	4.62	2.39	1.23
2TLG 150	1.80	357	268	223	146	110	1.85	89.2	62.6	49.4	36.6	28.5	23.6	20.6	16.6	13.7	11.7	6.34	3.29	1.69
	1.75	381	286	238	156	117	1.80	95.3	65.9	52.0	38.5	30.0	24.8	21.7	17.5	14.4	12.3	6.66	3.46	1.78
	1.67	412	309	261	160	120	1.75	96.7	67.9	53.5	39.7	30.9	25.6	22.3	18.0	14.9	12.6	6.88	3.56	1.83
2TLG 200	1.80	333	286	238	163	144	1.85	119	83.7	66.0	48.9	38.0	31.5	27.5	22.2	18.3	15.6	8.47	4.39	2.26
	1.75	395	318	272	196	154	1.80	127	88.1	69.4	51.4	40.0	33.2	28.9	23.4	19.3	16.4	8.92	4.62	2.37
	1.67	439	368	302	203	158	1.75	129	90.7	71.5	53.0	41.2	34.2	29.8	24.1	19.9	16.9	9.19	4.76	2.44
2TLG 250	1.80	416	356	297	229	180	1.85	148	104	82.2	60.9	47.4	39.3	34.2	27.7	22.8	19.4	10.6	5.47	2.81
	1.75	492	397	339	244	192	1.80	159	110	86.5	64.1	49.9	41.3	36.1	29.1	24.0	20.4	11.1	5.76	2.96
	1.67	547	459	377	253	196	1.75	161	113	89.1	66.0	51.4	42.6	37.1	30.0	24.8	21.0	11.4	5.93	3.04
2TLG 300	1.80	499	428	357	275	216	1.85	178	125	98.8	73.2	56.9	47.2	41.2	33.3	27.4	23.3	12.7	6.57	3.37
	1.75	591	477	408	294	231	1.80	191	132	104	77.0	59.9	49.7	43.3	35.0	28.9	24.5	13.4	6.92	3.55
	1.67	657	551	452	304	236	1.75	193	136	107	79.3	61.7	51.2	44.8	36.1	29.7	25.3	13.8	7.13	3.68
2TLG 375	1.80	623	534	445	342	269	1.85	222	156	123	91.2	71.0	58.8	51.3	41.5	34.2	29.1	15.8	8.19	4.21
	1.75	737	594	509	366	288	1.80	238	164	130	96.0	74.7	61.9	54.0	43.7	36.0	30.6	16.7	8.63	4.43
	1.67	820	667	564	378	294	1.75	241	169	134	98.9	77.0	63.8	55.6	45.0	37.1	31.5	17.2	8.86	4.56
2TLG 400	1.80	665	570	475	366	297	1.85	238	167	132	97.5	75.8	62.9	54.8	44.3	36.0	31.1	16.9	8.76	4.50
	1.75	787	636	543	391	307	1.80	254	176	139	103	79.8	66.2	57.7	46.7	38.5	32.7	17.8	9.22	4.73
	1.67	876	734	603	404	314	1.75	258	181	143	106	82.2	68.2	59.4	48.1	39.6	33.7	18.3	9.49	4.87
2TLG 450	1.80	747	641	534	411	323	1.85	267	188	148	110	85.2	70.6	61.6	49.8	41.1	34.9	19.0	9.84	5.05
	1.75	884	713	611	439	345	1.80	285	197	156	115	89.7	74.3	64.8	52.4	43.2	36.7	20.0	10.4	5.32
	1.67	984	826	677	454	353	1.75	289	200	160	119	92.4	76.6	66.8	54.0	44.5	37.8	20.6	10.7	5.48
2TLG 500	1.80	831	712	594	457	359	1.85	297	209	164	122	94.8	78.5	68.5	55.4	45.7	38.8	21.1	10.9	5.62
	1.75	984	793	679	469	384	1.80	317	220	173	128	99.7	82.7	72.1	58.3	48.1	40.9	22.2	11.5	5.91
	1.67	1094	917	753	505	393	1.75	322	226	178	132	103	85.2	74.3	60.0	49.5	42.1	22.9	11.9	6.09
2TLG 550	1.80	944	810	675	519	408	1.85	337	237	187	138	108	89.3	77.8	62.9	51.9	44.1	24.0	12.4	6.38
	1.75	1118	901	772	555	436	1.80	361	249	197	146	113	94.0	81.9	68.2	54.6	46.4	25.3	13.1	6.72
	1.67	1243	1042	856	574	446	1.75	366	257	203	150	117	96.6	84.4	68.2	56.3	47.8	26.0	13.5	6.92
2TLG 600	1.80	997	856	712	548	431	1.85	356	250	197	146	114	94.2	82.2	66.4	54.8	46.6	25.3	13.1	6.74
	1.75	1180	951	814	586	461	1.80	381	263	208	154	120	99.2	86.5	69.9	57.7	49.0	26.7	13.8	7.09
	1.67	1313	1100	903	606	471	1.75	386	271	214	158	123	102	89.1	72.0	59.4	50.5	27.5	14.2	7.31
2TLG 650	1.80	1081	926	772	594	467	1.85	386	271	214	158	123	102.1	89.1	72.0	59.4	50.5	27.5	14.2	7.30
	1.75	1279	1031	883	635	499	1.80	413	285	225	167	130	108	93.8	75.8	62.5	53.1	28.9	15.0	7.69
	1.67	1423	1193	979	657	511	1.75	419	294	232	172	134	111	96.8	78.1	64.4	54.7	29.8	15.4	7.92
2TLG 750	1.80	1248	1070	892	687	539	1.85	460	323	255	189	147	122	106	85.7	70.7	58.9	29.5	14.7	7.97
	1.75	1477	1191	1020	734	577	1.80	471	326	257	190	148	123	107	88.6	71.4	61.4	33.4	17.3	8.88
	1.67	1643	1378	1131	759	590	1.75	483	340	268	198	154	128	112	90.2	74.4	63.2	34.4	17.8	9.15
2TLG 800	1.80	1330	1140	950	732	575	1.85	475	334	263	195	152	126	110	88.6	73.1	62.1	33.8	17.5	8.99
	1.75	1574	1270	1067	782	615	1.80	506	351	277	205	160	132	115	93.3	77.0	65.4	35.6	18.4	9.46
	1.67	1752	1468	1206	809	629	1.75	515	362	285	211	164	136	119	96.1	79.3	67.4	36.7	19.0	9.75
2TLG 1000	1.80	1659	1422	1185	912	717	1.85	582	416	328	243	189	157	137	111	91.2	77.5	42.2	21.8	11.2
	1.75	1963	1583	1355	975	766	1.80	633	438	345	256	199	165	144	116	96.0	81.6	44.4	23.0	11.8
	1.67	2184	1831	1503	1009	784	1.75	642	451	356	264	205	170	148	120	98.8	84.0	45.7	23.7	12.2

Actual Battery Discharge Data may be +/-5% of figures shown.

Note: Largest single cell is 1000 ah

CELLYTE 2TLG - 2 Volt Cell Watts per Cell @ 20 C.

SEC 2 Volt Cell TYPE	END Volts / CELL	DISCHARGE W P C @ 20 C					END Volts / CELL	DISCHARGE DATA Watts Per Cell AT 20 C										
		DISCHARGE TIME IN MINUTES						DISCHARGE TIME IN HOURS										
		5	10	15	30	45		1	1.5	2	3	4	5	6	8	10	12	24
2TLG 50	1.80	217	164	138	91.3	70.3	1.85	57.4	38.4	30.4	22.7	17.8	14.8	13.0	10.5	8.55	2.09	1.08
	1.75	232	176	147	98.6	73.6	1.80	61.4	40.1	31.8	23.8	18.6	15.5	13.6	11.0	9.13	2.19	1.13
	1.67	250	185	160	101.2	76.0	1.75	62.0	40.8	32.4	24.2	19.0	15.8	13.9	11.3	9.33	2.24	1.16
2TLG 100	1.80	433	328	275	183	141	1.85	115	78.8	60.9	45.5	35.6	29.6	25.9	21.1	17.4	4.19	2.16
	1.75	483	351	294	197	147	1.80	123	80.3	63.6	47.5	37.2	31.0	27.1	22.1	18.3	4.39	2.26
	1.67	500	371	321	202	152	1.75	124	81.6	64.8	48.5	38.0	31.7	27.7	22.5	18.7	4.48	2.32
2TLG 150	1.80	648	490	410	272	209	1.85	171	115	90.7	67.7	53.1	44.2	38.6	31.4	26.0	6.24	3.22
	1.75	690	523	438	294	219	1.80	183	120	94.8	70.9	55.5	46.2	40.5	32.9	27.2	6.54	3.37
	1.67	745	553	478	302	227	1.75	185	122	96.5	72.3	56.6	47.2	41.3	33.6	27.8	6.68	3.45
2TLG 200	1.80	804	523	438	341	275	1.85	229	153	121	90.5	70.9	59.0	51.6	41.9	34.7	8.34	4.30
	1.75	714	582	501	369	288	1.80	244	160	127	94.6	74.1	61.7	54.0	43.9	36.3	8.73	4.51
	1.67	795	659	553	381	298	1.75	247	162	129	96.5	75.6	63.0	55.2	44.8	37.1	8.92	4.61
2TLG 250	1.80	752	652	548	425	343	1.85	285	191	151	113	88.3	73.5	64.3	52.3	43.3	10.4	5.35
	1.75	890	726	625	459	359	1.80	305	199	158	118	92.4	76.9	67.3	54.7	45.3	10.9	5.62
	1.67	890	821	689	475	371	1.75	307	202	161	120	94.3	78.6	68.8	55.9	46.3	11.1	5.74
2TLG 300	1.80	904	753	656	511	412	1.85	342	229	181	135	105	88.3	77.3	62.8	52.0	12.5	6.43
	1.75	1070	872	751	552	431	1.80	366	239	190	142	111	92.4	80.9	65.8	54.4	13.1	6.75
	1.67	1190	986	828	571	446	1.75	369	243	193	145	113	94.4	82.6	67.2	55.6	13.4	6.90
2TLG 375	1.80	1127	976	818	637	514	1.85	427	286	226	169	132	110	96.4	78.3	64.8	15.6	8.02
	1.75	1333	1087	936	688	536	1.80	458	298	236	177	138	115	101	82.0	67.9	16.3	8.41
	1.67	1483	1230	1032	711	586	1.75	460	303	241	180	141	118	103	83.7	69.3	16.7	8.61
2TLG 400	1.80	1204	1043	874	681	549	1.85	456	305	242	180	141	118	103	83.7	69.2	16.6	8.57
	1.75	1425	1162	1000	735	575	1.80	488	319	253	189	148	123	108	87.6	72.5	17.4	8.99
	1.67	1585	1314	1103	760	594	1.75	492	324	257	193	151	126	110	89.5	74.1	17.8	9.20
2TLG 450	1.80	1353	1172	982	765	617	1.85	512	343	271	203	159	132	116	94.0	77.6	18.7	9.63
	1.75	1601	1305	1123	826	646	1.80	548	358	284	212	166	138	121	98.4	81.5	19.6	10.1
	1.67	1781	1476	1239	854	667	1.75	553	364	289	216	170	141	124	101	83.2	20.0	10.3
2TLG 500	1.80	1504	1304	1092	850	686	1.85	570	381	302	225	177	147	129	106	80.5	20.8	10.7
	1.75	1780	1451	1249	919	718	1.80	609	398	316	236	185	154	135	109	80.6	21.8	11.2
	1.67	1981	1642	1378	950	742	1.75	615	405	321	241	189	157	138	112	82.6	22.2	11.5
2TLG 550	1.80	1709	1481	1241	966	780	1.85	648	433	343	256	201	167	146	119	98.3	23.6	12.2
	1.75	2023	1649	1420	1044	816	1.80	692	452	359	268	210	175	153	124	103	24.7	12.8
	1.67	2251	1868	1566	1079	843	1.75	699	460	365	273	214	179	156	127	105	25.3	13.1
2TLG 600	1.80	1805	1564	1310	1020	823	1.85	684	457	362	270	212	176	154	125	104	24.9	12.8
	1.75	2135	1741	1499	1102	861	1.80	731	478	379	283	222	185	162	131	109	26.1	13.5
	1.67	2376	1970	1653	1140	890	1.75	737	486	386	289	226	188	165	134	111	26.7	13.8
2TLG 650	1.80	1958	1695	1420	1106	892	1.85	741	496	393	293	230	191	167	136	112	27.0	13.9
	1.75	2315	1887	1625	1194	934	1.80	792	518	410	307	240	200	175	142	116	28.3	14.6
	1.67	2576	2135	1792	1235	965	1.75	799	527	418	313	245	204	179	145	120	28.9	14.9
2TLG 750	1.80	2259	1958	1641	1277	1030	1.85	856	590	467	349	273	228	199	162	134	28.0	13.5
	1.75	2674	2180	1876	1380	1078	1.80	915	592	469	351	275	229	200	163	135	32.7	16.9
	1.67	2975	2488	2070	1427	1115	1.75	923	608	483	361	283	236	207	168	139	33.4	17.3
2TLG 800	1.80	2408	2087	1749	1361	1098	1.85	912	610	483	361	283	235	206	167	138	33.3	17.1
	1.75	2850	2324	2000	1470	1149	1.80	975	637	505	378	296	246	216	175	145	34.8	18.0
	1.67	3170	2628	2206	1521	1188	1.75	984	648	514	385	302	252	220	179	148	35.6	18.4
2TLG 1000	1.80	3003	2602	2180	1697	1369	1.85	1138	761	603	450	353	293	267	209	173	41.5	21.4
	1.75	3553	2897	2494	1833	1433	1.80	1216	795	630	471	369	307	269	219	181	43.4	22.4
	1.67	3953	3277	2751	1896	1481	1.75	1227	808	642	480	376	314	274	223	185	44.4	22.9

Actual Battery Discharge Data may be +/-5% of figures shown.

Note: Largest single cell is 1000 ah

SEC 2TLG 2 Volt Gel Range - Battery Specification

SEC CELL TYPE	CELL Volts	Nominal Capacity Amp Hour	Cell Length (L) mm	Cell Length (L) Inch	Cell Width (W) mm	Cell Width (W) Inch	Cell Height (H1) mm	Cell Height (H1) Inch	Cell Height (H2) mm	Cell Height (H2) Inch	Cell Weight KG	Cell Weight lbs	Inter. Res. mΩ/ohms	Short Circuit Current	No. of Term.	Terminal Type
SEC 2TLG-50	2	50	161	6.34	50	1.97	166	6.54	166	6.54	4.5	9.90	1.080	460	2	FT 4
SEC 2TLG-100	2	100	171	6.73	72	2.83	295	8.07	245	9.65	8.0	17.6	0.840	970	2	FT 4
SEC 2TLG-150	2	150	172	6.77	102	4.02	295	8.07	245	9.65	11.0	24.2	0.720	1395	2	FT 4
SEC 2TLG-200	2	200	173	6.81	111	4.37	329	12.95	365	14.37	14.0	30.8	0.600	1440	2	FT 5
SEC 2TLG-250	2	250	173	6.81	111	4.37	329	12.95	365	14.37	18.0	39.6	0.540	1900	2	FT 5
SEC 2TLG-300	2	300	171	6.73	151	5.94	330	12.99	366	14.41	21.0	46.2	0.480	2160	2	FT 5
SEC 2TLG-375	2	375	211	8.31	176	6.93	329	12.95	367	14.45	23.5	51.7	0.468	2700	2	FT 5
SEC 2TLG-400	2	400	211	8.31	176	6.93	329	12.95	367	14.45	27.0	59.4	0.432	2880	4	FT 5
SEC 2TLG-450	2	450	223	8.78	187	7.36	351	13.82	373	14.69	30.0	66.0	0.396	3240	4	FT 5
SEC 2TLG-500	2	500	211	8.31	176	6.93	329	12.95	367	14.45	32.0	70.4	0.360	3600	4	FT 5
SEC 2TLG-550	2	550	223	8.78	187	7.36	351	13.82	373	14.69	35.0	77.0	0.348	4140	4	FT 5
SEC 2TLG-600	2	600	301	11.85	175	6.89	331	13.03	366	14.41	40.0	88.0	0.336	4320	4	FT 5
SEC 2TLG-650	2	650	301	11.85	175	6.89	331	13.03	366	14.41	47.0	103	0.300	4500	4	FT 5
SEC 2TLG-750	2	750	301	11.85	175	6.89	331	13.03	366	14.41	55.0	121	0.264	5400	4	FT 5
SEC 2TLG-800	2	800	410	16.14	175	6.89	330	12.99	365	14.37	57.0	125	0.240	5760	8	FT 5
SEC 2TLG-1000	2	1000	410	16.14	175	6.89	330	12.99	365	14.37	63.0	139	0.192	7110	8	FT 5

Battery Dimensions may be changed without prior notice.

Terminal Type FT 4

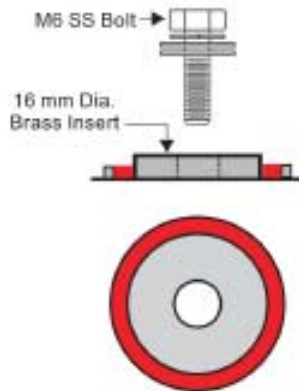

16 mm \varnothing Brass Insert Terminal for M6 Bolt

Terminal Type FT 5

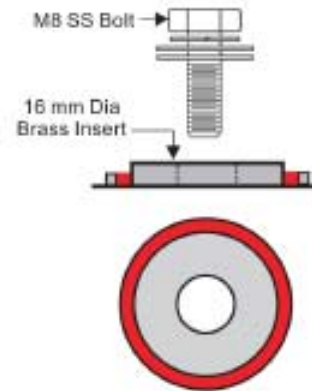

16 mm \varnothing Brass Insert Terminal for M8 Bolt

Cell Dimensions for rack layout

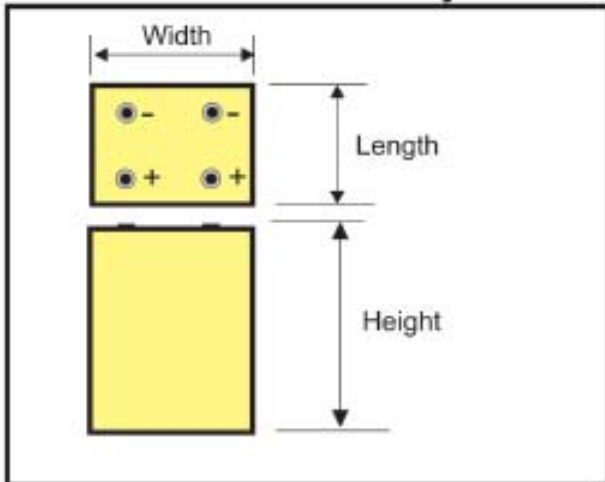

Standards / Approvals

UL approval
 BS 6290 Part 4 (Optional)
 Eurobat (Draft IEC 896-2)
 IEEE
 JIS

CELLYTE 2TLG Bloc - PERFORMANCE CURVES

SELF DISCHARGE CHARACTERISTIC

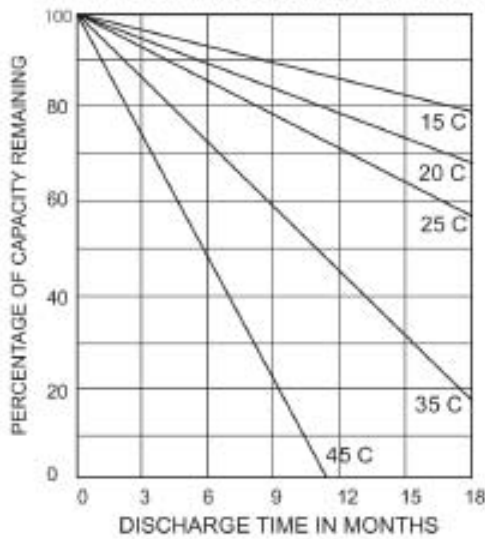

OPEN CIRCUIT VOLTAGE vs CAPACITY

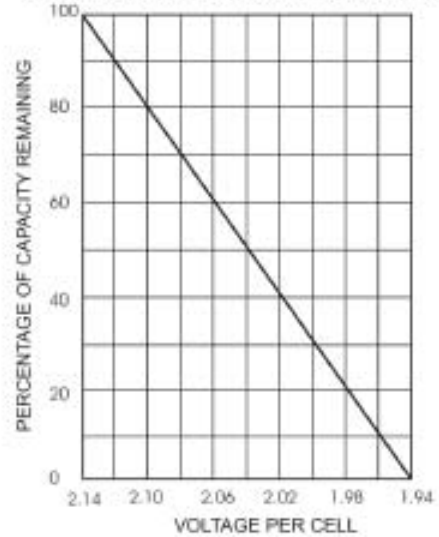

Recommended Charging Voltages:- Float/Boost $2.25 \pm 1\%$ Vpc at 20/25C & Cycle Service $2.35 \pm 1\%$ Vpc at 20/25C

Endurance in cycles according to IEC 896-2

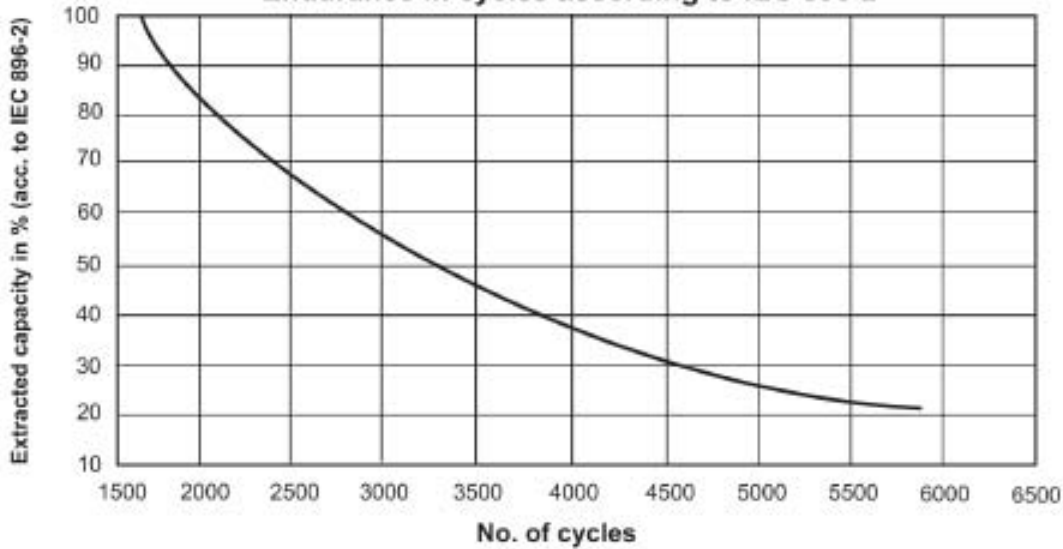

Benefits of Catalyst in SEC VRLA Batteries

Catalyst Reduces Float Current

One of the most immediate, observable effects of installing a catalyst in a VRLA cell is a sudden drop in the float current. Typically float currents are one half or less when a catalyst is installed. Adding a catalyst to the cell prevents some of the oxygen reaching the negative plate and allows the negative plate to stay polarised. This means that less current needs to be supplied to the cell from the charging system, manifesting itself as lower float current, leading to the following benefit :-

* Minimize water loss

Gasses are recombined into water inside the cell rather than exiting the cell. Too much gas leaving the cell can lead to premature dry-out and cell failure. Cell dry is a major cause of VRLA cell failure.

* Increased life

There are many potential failure modes of VRLA cells. A number of these failure modes can be mitigated by the catalyst technology such as: Cell dry out, positive plate corrosion, thermal runaway, capacity loss due to negative plate depolarization

* Minimize positive plate corrosion

A reduction in float current reduces the amount of over-charge on the positive plate which directly impacts the corrosion rate. The design life of a lead acid cell is based on the corrosion of the plate barring any other unforeseen failure modes.

* Maintain cell capacity

Many VRLA cells in service are failing capacity tests because their negative plates are depolarized. In fact significant capacity increases have been seen on some cells just by installing a catalyst.



CELLYTE 2CMT/G Modular



CELLYTE 2TLAM/G Tubular



CELLYTE 2CMT/G, 2TLAM/G with Catalyst



CELLYTE 12FTA/G Range



CELLYTE 6-12TLA Range



CELLYTE 6-12TUA Range



CELLYTE 6-12TLG Range



CELLYTE 6-12TSG Range



MICROLYTE +Plus Range



MICROLYTE Red Top Range



CELLYTE 2TLA/G Range



**SEC 2ETG OPzV Range
in Tubular Rack**



SEC Tubular OPzS Range



SEC Nickel Cadmium Range



Typical VRLA Catalyst



CELLYTE 2CMT/G Modular



CELLYTE 2TLAM/G Tubular



CELLYTE 2CMT/G, 2TLAM/G with Catalyst



CELLYTE 12FTA/G Range



CELLYTE 6-12TLA Range



CELLYTE 6-12TUA Range



CELLYTE 6-12TLG Range



CELLYTE 6-12TSG Range



MICROLYTE +Plus Range



MICROLYTE Red Top Range



CELLYTE 2TLA/G Range



**SEC 2ETG OPzV Range
in Tubular Rack**



SEC Tubular OPzS Range



SEC Nickel Cadmium Range



Typical VRLA Catalyst