

stringMoni[®]

Management and control system
for photovoltaic plants

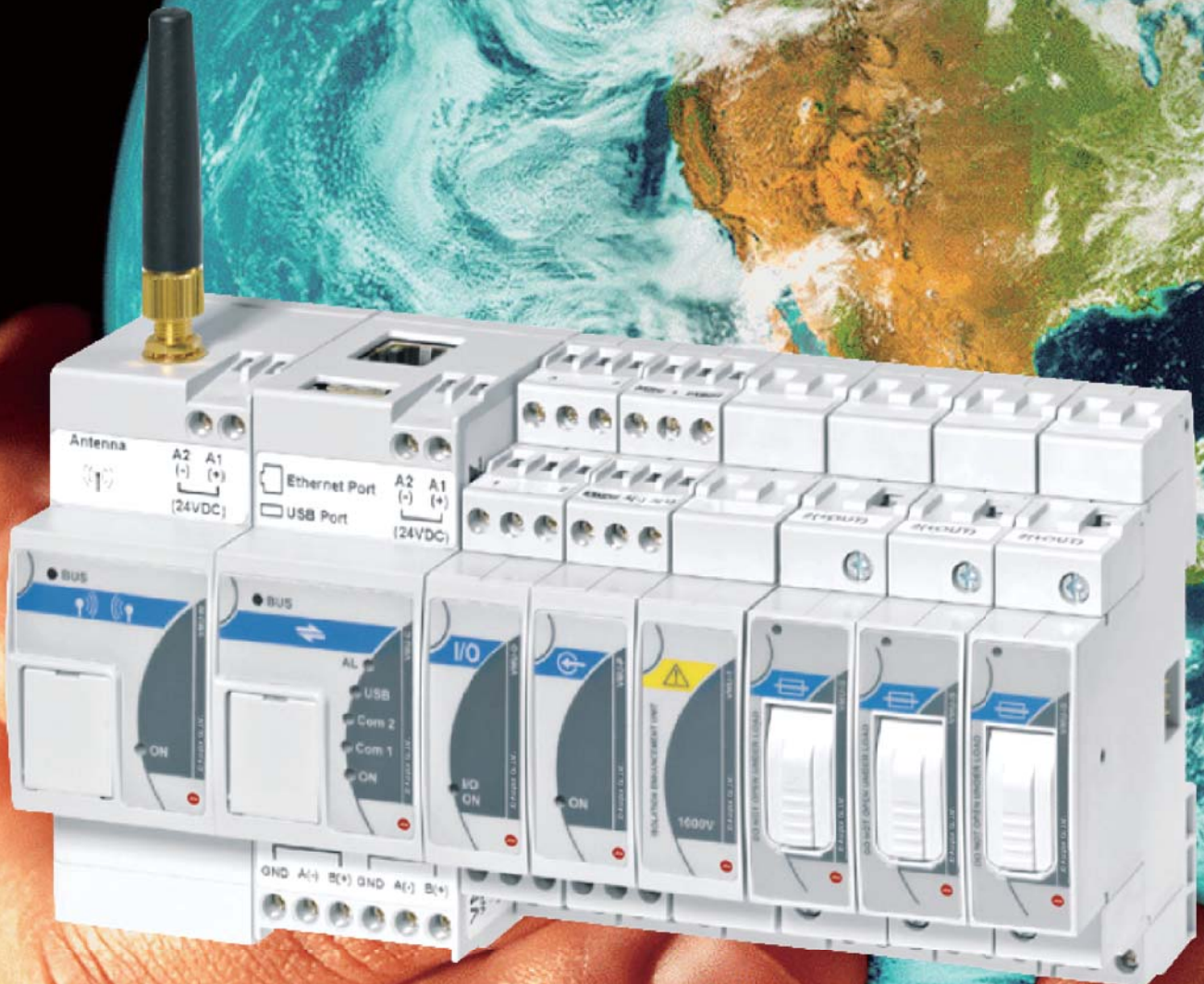

Index

- Smart combiner box pvBos™ scheme -----p03-p04
- Management and Control system for Photovoltaic Plants ----- p05
- How can you protect your investment ----- p06
- Information and Control by stringMoni™, stringMoni™ Lite -----p07-p08
- Information and Control stringMoni™ and stringMoni™-Web -----p09-p12
- stringMoni™ server -----p13-p14
- SCADA ----- p15
- Antitheft ----- p16
- Retrofit Solution -----p17
- The main differences between the two monitoring solutions ----- p18-p19

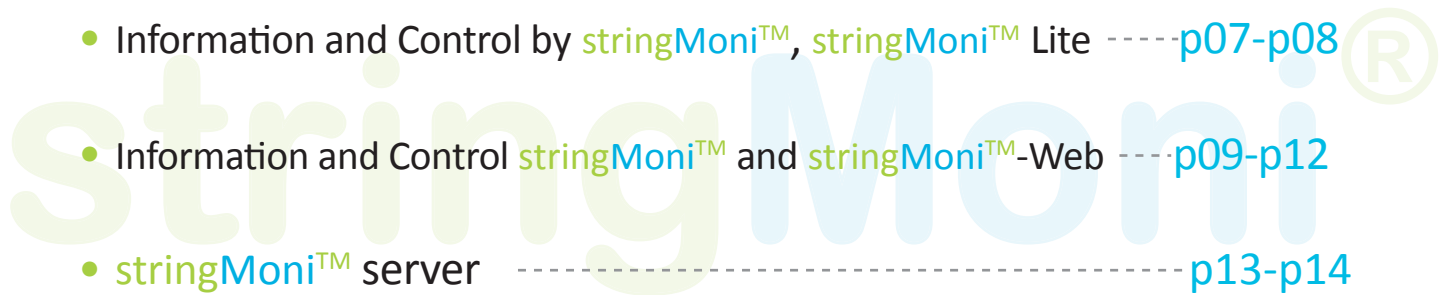

Adding a control solution is now easy!

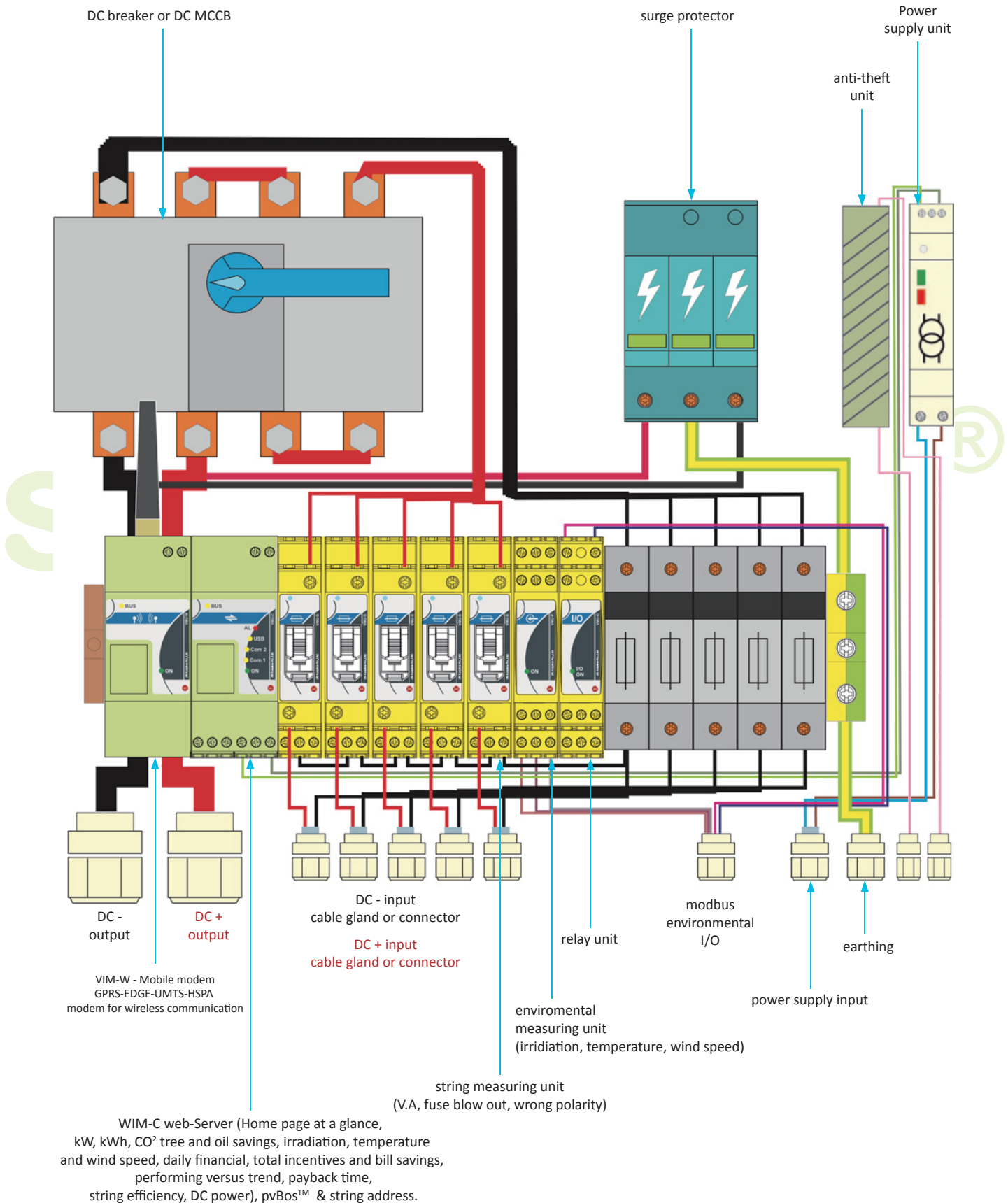

Adding a control solution is now easy!

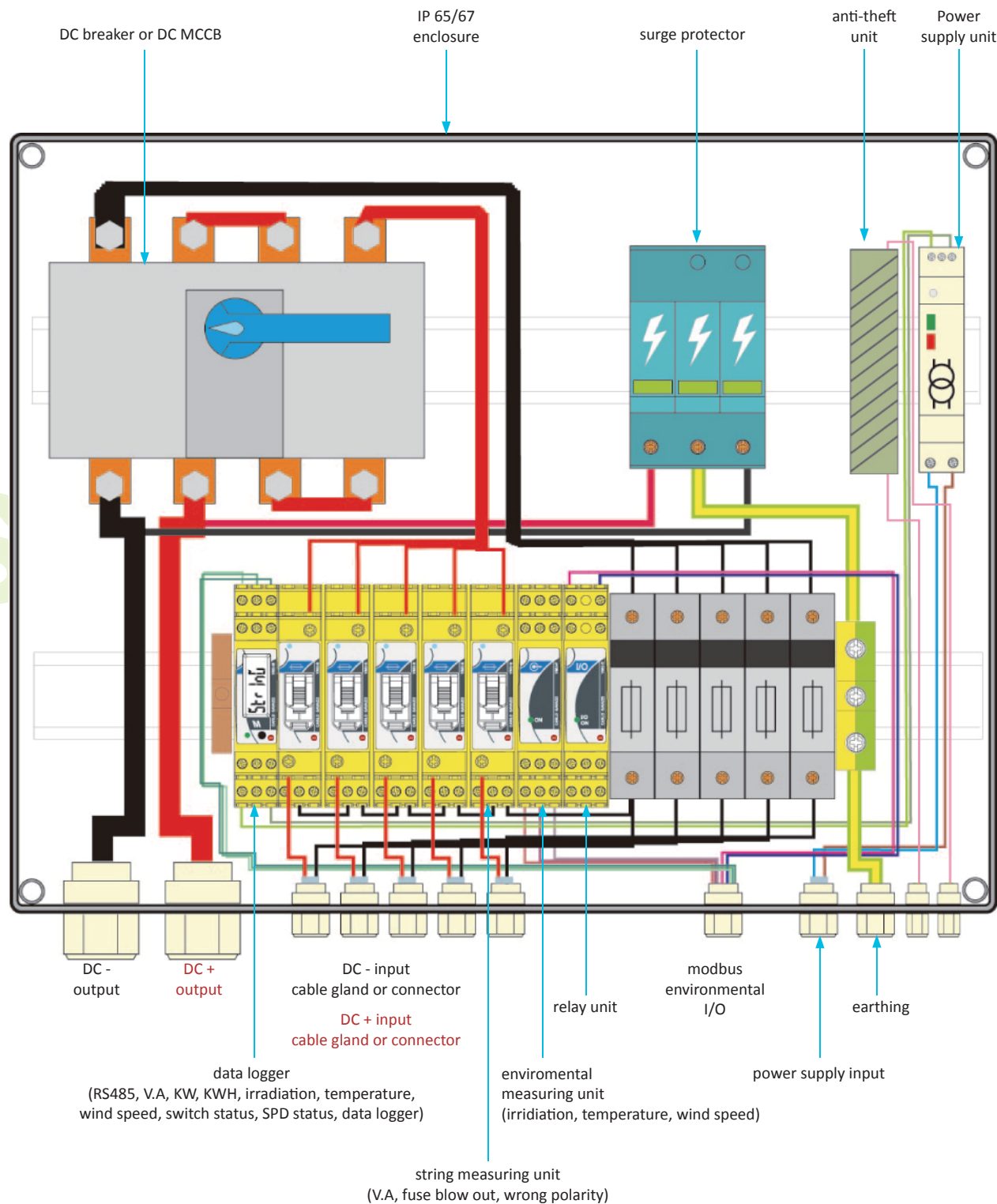

stringMoni®, Sever, stringMoni®-Web

Protecting the environment is a fundamental ideal that requires dedication and care, which is why every solar project is a vital project. It needs the same attention that we devote to the things we love. Care and attention, are essential values for JD Auspice, when developing the control system for photovoltaic plants. This ensures the solar investment is a solid investment.

The JD Auspice solution develops with stringMoni®, stringMoni®-Web and stringMoni® server depending upon the requirements and complexity of the photovoltaic plant. stringMoni® and stringMoni® Lite are systems comprised of individual modular elements that, when interacting with one another, provide efficient local control to the solar plant. Whether it's a small/medium power or high power plant, you are assured there is effective information management.

The stringMoni® provides a compact, simple, versatile and innovative solution. stringMoni® server is a web server suitable to control and supervise medium to big PV plants, while stringMoni®-Web is the ideal solution for small to medium installations. stringMoni®-Web is capable in its specific integrated web-service functionality to automatically push the data to WEB portals. Both solutions can gather data from:

- stringMoni® groups;
- Inverters;
- Energy meters.

The stringMoni® server and the stringMoni®-Web provide information in a quick and automatic fashion via the internet, so the data is available wherever you are.



Management and Control system for Photovoltaic Plants

stringMoni® :

- Measurement and control functions split into independent modules in order to improve the critical system reliability.
- String efficiency and BOS efficiency measurements are fundamental parameters to evaluate the yield of the photovoltaic plant.
- Local alarm management for fast and easy identification.
- Integrated fuse protection for cost and installation time saving.
- stringMoni® application adaptability - the customer can choose according to his project philosophy which unit/s best suits his application giving him the freedom to find different solutions to his application problems.
- Features expansion capability based on usage of different modules and quantities so to meet application needs from small (10kWp) to large solar PV plants.
- Multicolor LEDs provide immediate feedback on variables, alarms, fuse status and communication, showing the relevant details on the display.

stringMoni® server :

- Cost effective yield efficiency and plant failure warning with additional manual or automatic database download for easy plant history analysis.
- Plant failure warning by means of e-mail and sms in the case of external connection via modem. Plant database download by means of stringMoni® Soft.
- Notification of abnormal conditions as soon as they occur for a prompt service intervention.
- Comprehensive control solution capable of showing efficiency, yield graphs and the management of any useful information which is accessible by the user from any place in the world just by using his PC browser.

stringMoni®-Web :

- Monitoring up to 1MWp photovoltaic installations by means of either its Web-Server capability or a remote Web portal function depending on the module.
- Data polling (measurements and alarms) from stringMoni®, stringMoni® Lite solution, energy meters and inverters transmitted to a remote web-server by means of Internet, using web-services to avoid firewall related issues.
- Use of "XML" (Extensible Markup Language) based communication protocols granting high degree of flexibility, allowing stringMoni®-Web to push data to multiple monitoring portals, like the JD Auspice Web Portal.

How can you protect your investment

A solar installation, never mind if it's small or large it's always an important investment. You can protect your investment if :

- You meet the performance limits!
- You know the system is working properly!
- You realize the hoped-for solar electric performance level!
- You prove that you've produced results!
- You payback the investment!



The major control solution today

- Has fixed number of string controllers
- Is space consuming
- Is complex to wire
- Is difficult to repair when failure occurs
- Has yield data available mainly from the inverter.

How much money will you lose if your solar system stops for three days? To ensure you don't lose money then you need a CONTROL solution.

A reliable control ... has to be an independent control!



Providing you with dependable and accurate data, promptly advising when :

- The photovoltaic modules are not performing
- The photovoltaic modules are not correctly connected
- The modules are removed (theft)
- The inverter fails

Moreover, focused control on every single string provides an immediate localization of the fault reducing significantly the service time and the missed yield costs.

stringMoni® and stringMoni®-Web : Versatile, a characteristic that makes work easier



stringMoni® is modular and can be formed by :
 VIM-M the master unit and data logger;
 VIM-S the string controller;
 VIM-P the environment variable unit,
 VIM-O the I/O unit,
 VIM-AT the antitheft sensor and VIM-1 the isolation enhancement unit. All String monitor functionalities can be available on your browser simply adding now VIM-C the Web-Server a wired internet is available or adding a further VIM-W a GPRS-EDGE-UMTS-HSPA modem for wireless communication.



Integrated fuse protection

Information and Control... Everywhere

Local

stringMoni® control with local alarm output and with the additional possibility to be connected to a PC running freeware stringMoni® Soft. Cost effective yield efficiency and plant failure warning with additional manual or automatic database download for easy plant history analysis.

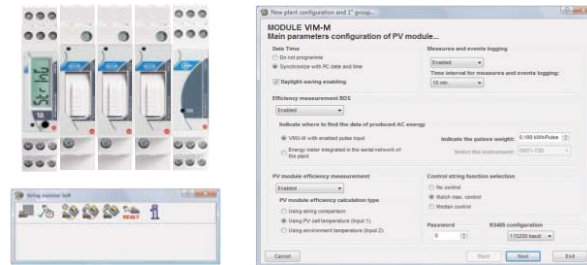

Remote

Plant failure warning by means of proper sms or e-mail notifications as soon as they occur using GSM-GPRS-EDGE-UMTS-HSPA (VIM-C+ VIM-W) integrated communication technology.



Advanced

stringMoni®-Web as a compact Web-Server and stringMoni® server as an Embedded PC are capable to gather data from: stringMoni®, Inverters and Energy Meters. Comprehensive control solution capable of showing efficiency, yield graphs and the management of any useful information which is accessible by the user from any place in the world just by using his PC browser.



stringMoni® Lite

stringMoni® Lite is the answer to those photovoltaic applications where a less sophisticated control is needed. This solution is based on the same overall concept of stringMoni® such as modularity, integrated string fuse protection but being focused to measure and control only the string current and voltage. As undoubted result this string control provides an immediate string failure detection and localisation of the wrong PV panel connection, a faster plant commissioning and future maintenance. stringMoni® Lite is specifically developed to be integrated in either a small or medium size photovoltaic park where all the most significant data are transmitted via RS485 Modbus at a maximum speed of 115.2 kbit/s to the local PV Energy Management System. An essential working tool is represented by stringMoni®LSoft a freeware software which allows the user to easily configure stringMoni® Lite, check the communication wiring and remotely read the available measurement data.



stringMoni® Lite

Why to choose stringMoni® or stringMoni® Lite

As each application has unique requirements, JD Auspice has designed distinctive products for solar applications offering an advanced control solution : • stringMoni® or a simplified control solution : • stringMoni® Lite



stringMoni® completeness of control, and antitheft control



stringMoni® Lite synthesis of control

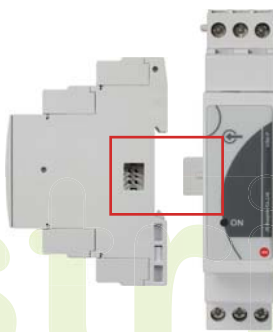

stringMoni® and stringMoni® Lite are provided with a specific communication and power supply bus that allows the modules to communicate each other in any needed configuration thus simplifying and reducing the installation time.



Versatility of stringMoni® and stringMoni® Lite

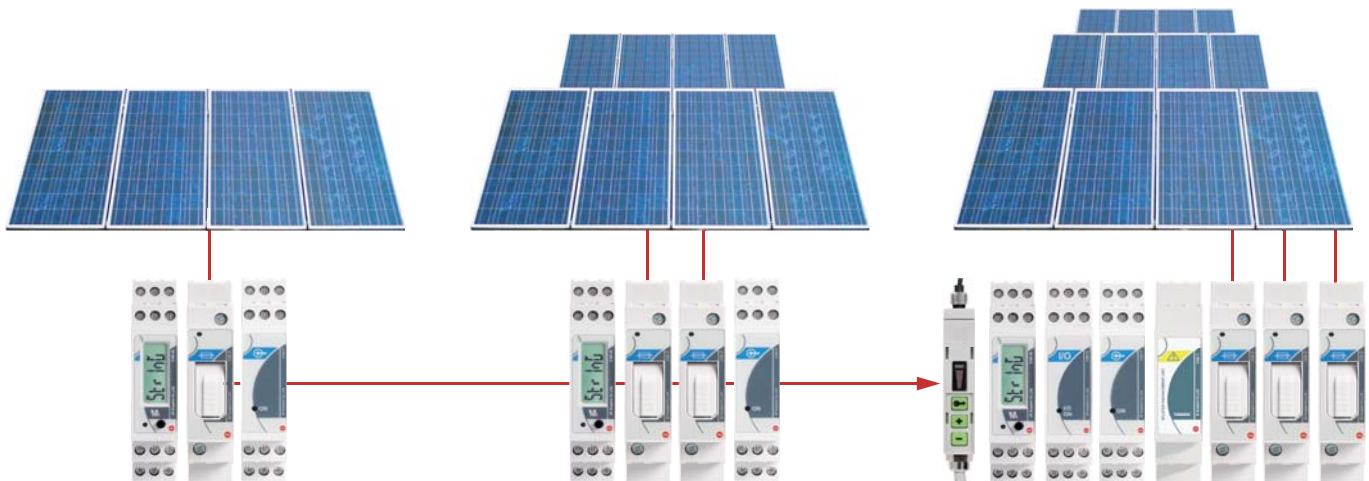

stringMoni® can be formed by :
 1 VIM-M, up to 15 VIM-S, up to 7 VIM-O,
 up to 1 VIM-P but not exceeding 16 units
 and up to 3 additional VIM-ANTI antitheft sensors.

stringMoni® Lite can be formed by :
 1 VIM-ML, up to 15 VIM-S0, up to 2 VIM-O,
 up to 1 VIM-P but not exceeding 16 units in total.

If an isolation to earth up to 1000VDC (instead of standard 800VDC) is requested, one VIM-1 can be added between the VIM-S/VIM-S0 group of units and all the other units, in this latter case the total number of units cannot exceed 17.

A New Integrated Wired or Wireless Web-Server and Web-Service Solution

As for the rooftop applications there is the need to provide a more integrated and flexible remote monitoring equipment, JD Auspice introduces the first modular web access solution, specifically developed for medium to small PV plants.



Since plant data are very important, VIM-C provides also a specific micro SD slot to host, according to the needs, up to 16GB back-up memory. The following functions are available:



- plant configuration and database and events export download;
- XML driver (energy meters and inverters), plant configuration and firmware upgrade upload.

“Device” mini USB can be connected to a PC to perform a firmware upgrade and other service functions.
“Host” USB with hot swap capability to host a memory stick providing download and upload functions.

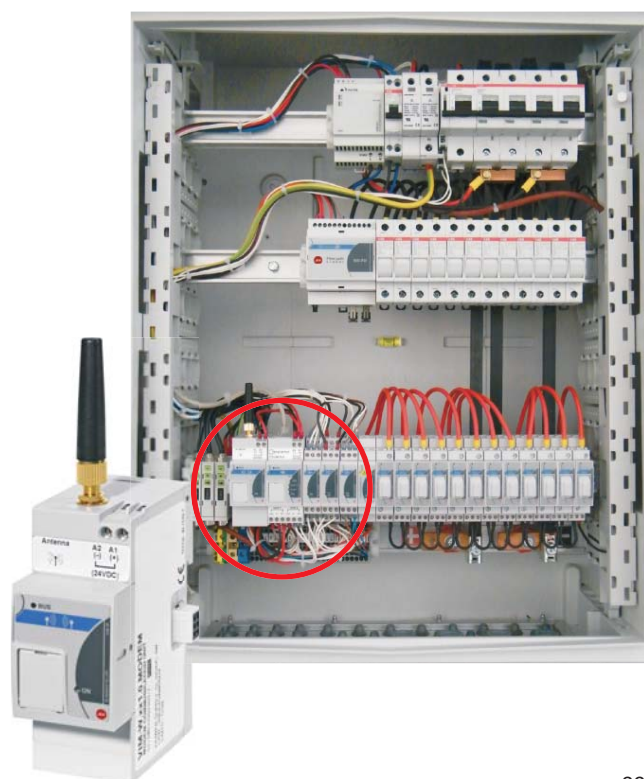

Where wired Internet access is not available, JD Auspice provides a specific mobile modem “VIM-W” to be added to “VIM-C” which transforms the standard stringMoni® into stringMoni®-Web, an even more advanced remote control solution.

On the left there is an example of stringMoni® server with fully integrated Web-server and mobile communication system.

Such stringMoni® server is the master to manage up to 10 more slave string boxes for a total power which can range from 500kWp to 1MWp.

The stringMoni® comprehensive Monitoring Solution

Monitoring solution based on web-service protocols for PV installations up to 1MWp

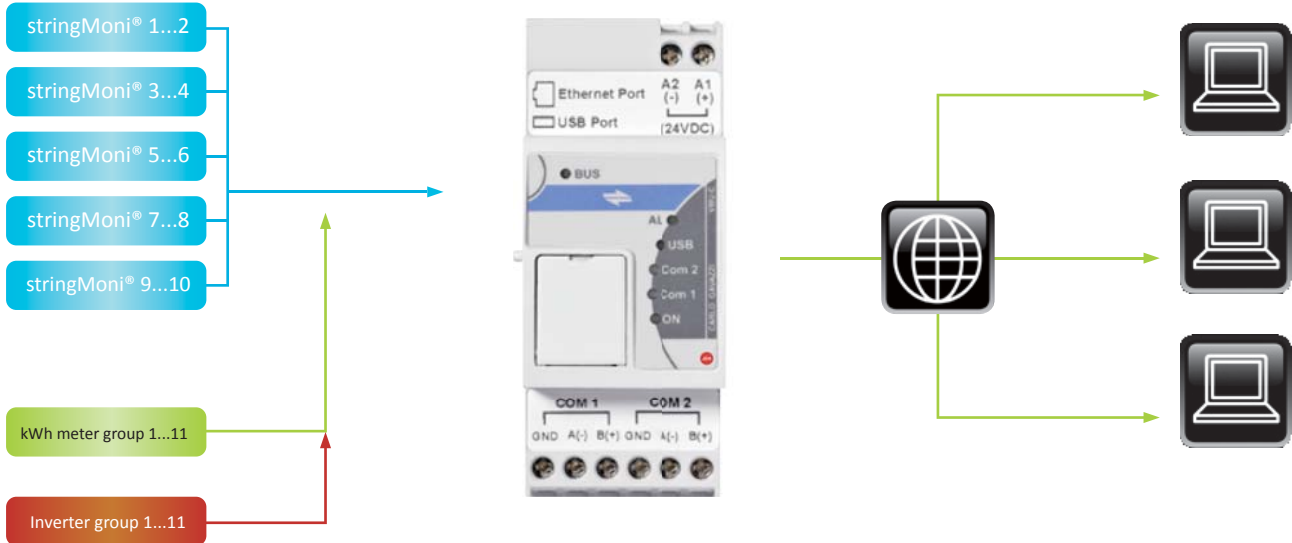

WEB Portal

Overall features

- Plant information based on available portal services (alarms, graphical and analytical yield trends).
- Data polling (measurements and alarms) from different site devices transmitted to a remote web-server by means of internet, using web-services to avoid firewall related issues.
- Use of "XML" (Extensible Markup Language) based communication protocols granting high degree of flexibility, allowing stringMoni®-Web to push data to multiple monitoring portals.
- 12 to 28VDC power supply.
- DIN-rail mounting type.

Compatibility to :

- stringMoni® solution;
- stringMoni® Lite solution;
- JD Auspice and other Inverter manufacturer;
- JD Auspice energy meters.

This architecture can manage up to :

- 10+1 stringMoni® or stringMoni® Lite;
- 11 inverters;
- 11 energy meters.

The stringMoni® comprehensive Monitoring Solution

Monitoring solution based on web-server communication capability for commercial PV installations up to 1MWp

Example of communication architecture with wired Internet access only with “VIM-C” unit or where Internet, for any reason is not available, with additional mobile GPRS-EDGE-UMTS-HSPA “VIM-W” plug-in unit.

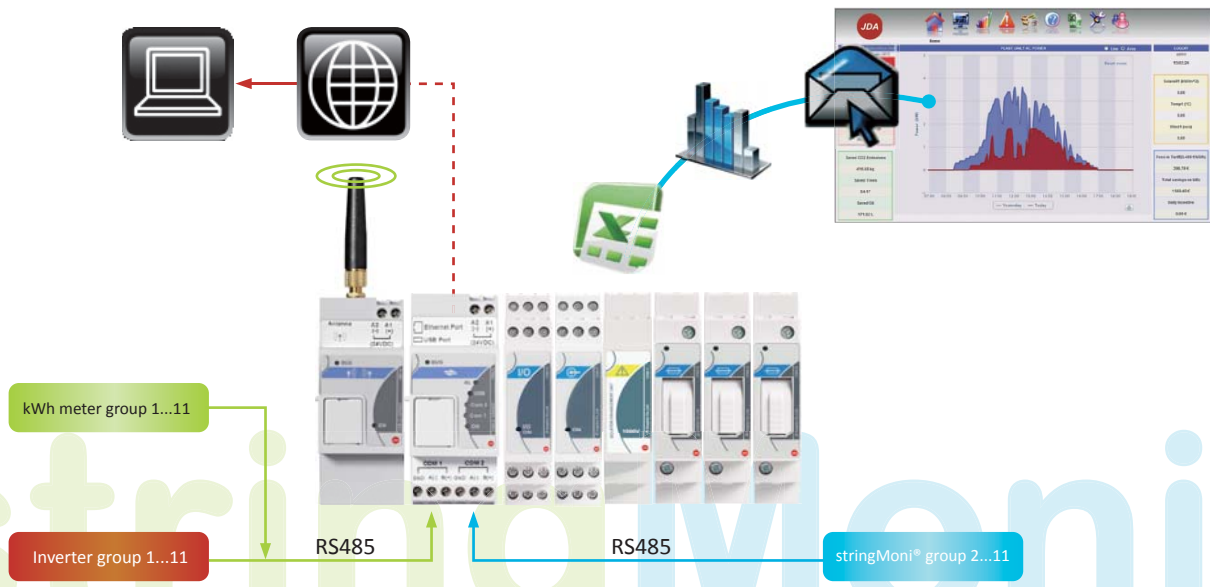

For those more simple residential 1.5kWp to 20kWp installations where a less sophisticated monitoring solution is needed, JD Auspice provides VIM-C, a local web-based data management system which gathers measurements and status information from one or more inverters to your PC or to a centralised cloud monitoring solution. As in some rented roofs, wired internet is not available, VIM-W solves the problem using well spread mobile communication.

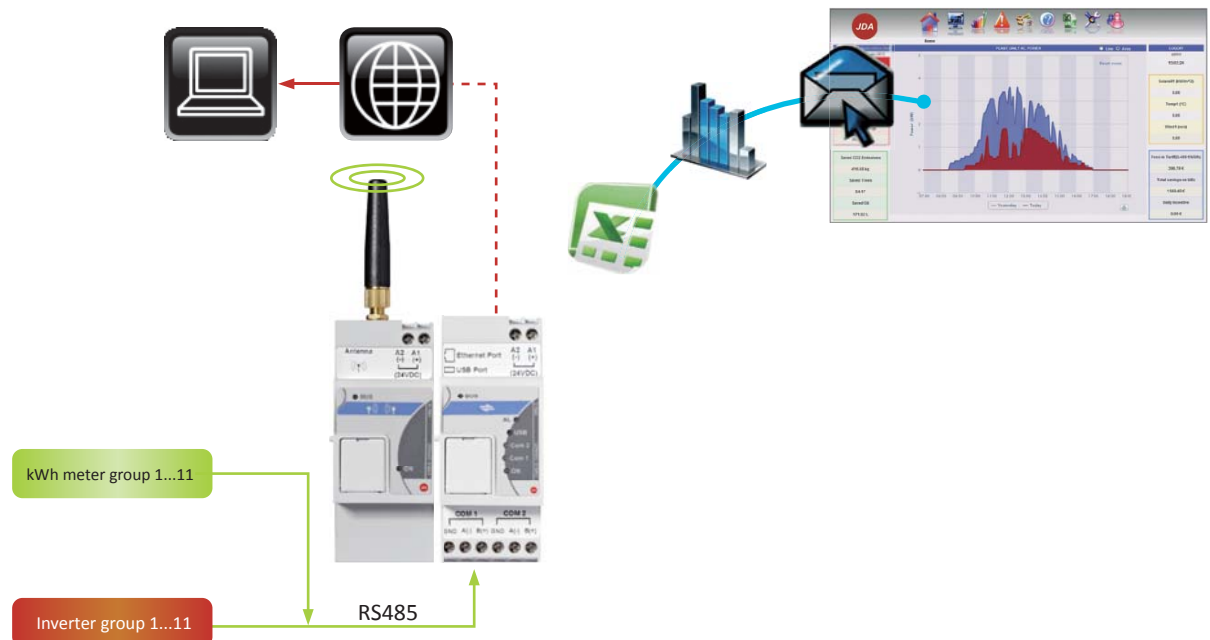

The stringMoni® comprehensive Monitoring Solution

Home page with the following information available at a glance:

- electrical plant information such as kW, daily and total produced kWh;
- environmental savings such as CO2
- environmental parameters such as solar irradiation, temperature and wind speed;
- financial information such as daily, total incentives and bill savings.

The main graph shows actual yield vs. the day before.



Yield index with an example of daily trend over the month. This information allows the PV plant owner to understand at a glance how the installation is performing versus the original engineering so to judge the investment payback time.



Combined string efficiency, DC power, solar irradiation and temperature trends. The aim of this important page is to understand how the plant is performing keeping under control the efficiency and power of PV modules vs. irradiation-temperature couple. An inefficiency highlight would need further investigations by service people so to clearly identify the nature of the problem.



A further analysis support is represented, among many, by a single or multiple inverter power graph and also, proving the flexibility of this solution, by the download selection page which allows the user to combine data in an Excel spreadsheet so to customise the data analysis by type of variable and needed time period.

The stringMoni® comprehensive Monitoring Solution

Monitoring solution based on embedded web-server for PV farms up to 5MWp

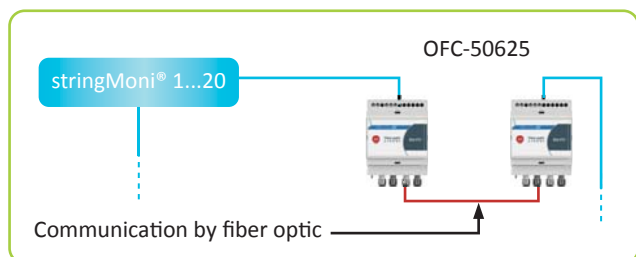

For a highly disturbed installation, because of centralised Inverters a glass fibre optic communication system is available with single loop or double loop communication.

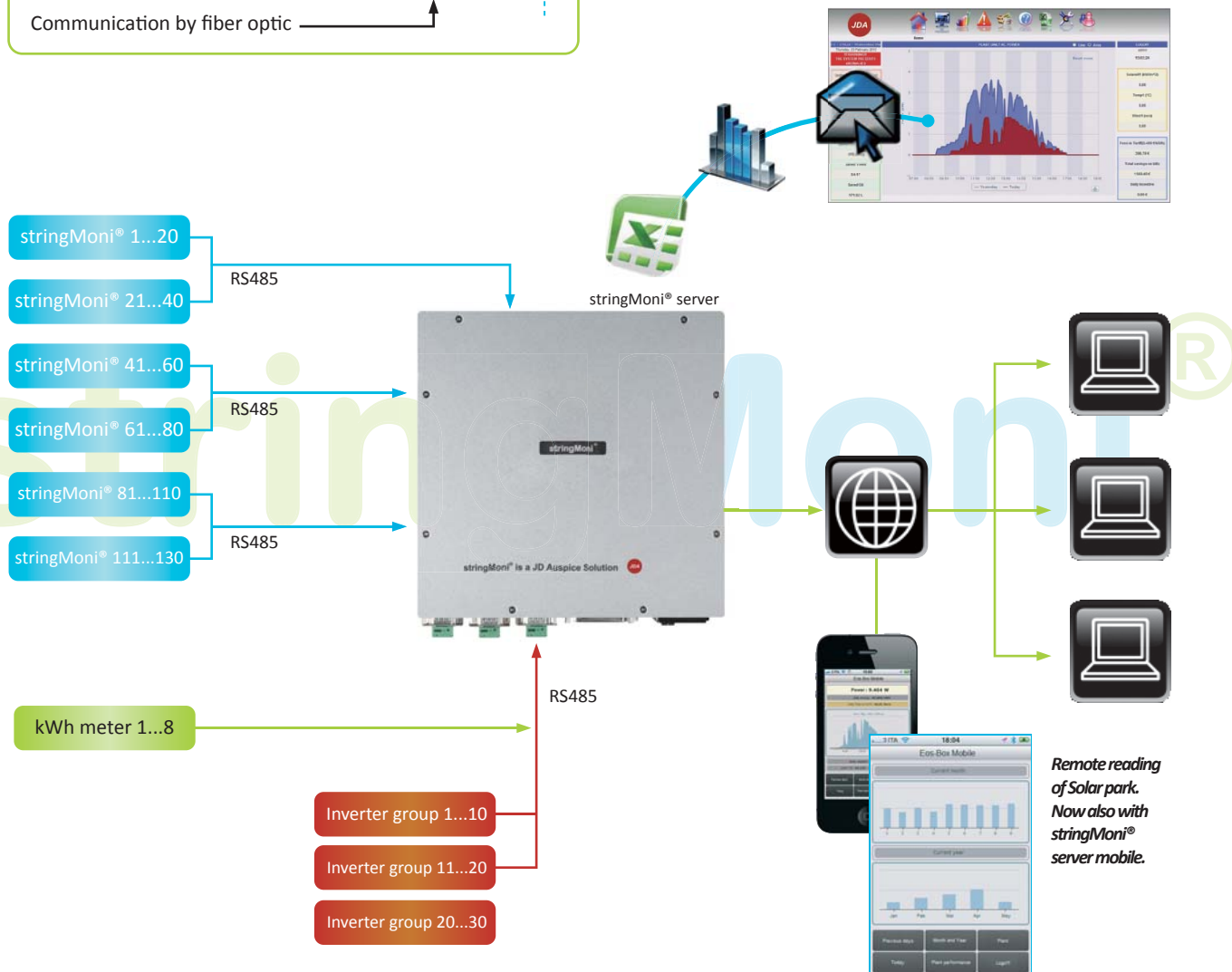

Remote reading of Solar park. Now also with stringMoni® server mobile.

Overall features

- Plant information.
- Plant map for failure localization.
- Webcam management.
- Real-time display with alarm indication.
- Graphical and analytical yield trends.
- Alarm and events logging.
- Extremely high level of data reliability and management because of local String monitor data logging and stringMoni® server centralised data logging. In case of stringMoni® failure the centralised data logging. In case of stringMoni® failure the data is available in stringMoni® server and vice versa.
- 100 to 240VAC power supply
- Wall/DIN-rail mounting type

Compatibility to:

- stringMoni® solution;
- JD Auspice and more than 30 different inverter manufacturers;
- JD Auspice and other energy meters.

This architecture can manage up to:

- 130 stringMoni® (9600 bps communication speed and 10 min time interval);
- 30 Inverters (depending on inverter's communication speed);
- 8 energy meters.

The stringMoni® comprehensive Monitoring Solution

Examples of stringMoni® server main pages

Yield index with an example of daily trend over the months. This information allows the PV plant owner to understand at a glance how the installation is performing versus the original engineering so to judge the investment payback time



Combined string efficiency, DC power, solar irradiation and temperature trends. The aim of this important page is to understand how the plant is performing keeping under control the efficiency and power of PV modules vs. irradiation-temperature couple. An inefficiency highlight would need further investigations by service people so to clearly identify the nature of the problem.

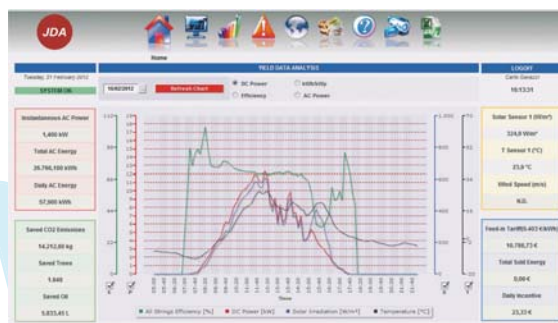

The causes of inefficiencies can be located in either DC generation or DC/AC conversion (inverter) area, therefore a very powerful analysis tool is needed. The combined DC power, DC current, DC voltage and solar irradiation answers to the DC generation question, it provides all the information which are needed to localise the problem.



Some other examples of other tools gives the idea of how deep the analysis can be pushed. The single string behaviour (A, V, kW, kWh) shows you the difference of behaviour from string to string so to identify the one which is supposed to have the anomaly while a series of information relevant to the inverter shows how it really behaves.

The stringMoni® comprehensive Monitoring Solution

Monitoring solution based on system integrator's own SCADA software

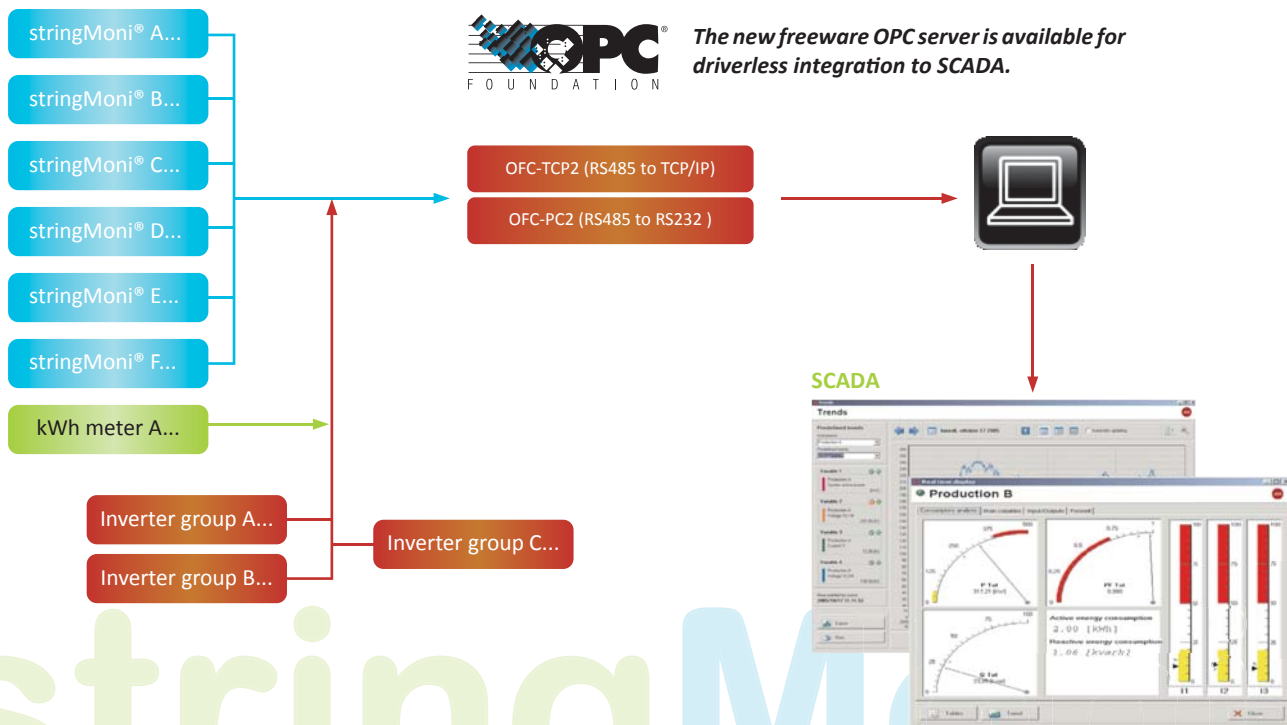

The new freeware OPC server is available for driverless integration to SCADA.

- Architecture freedom
- Measurement features depending on String monitor selected solution (either String monitor or stringMoni® Lite)
- Free String monitor communication protocol available on request.

OFC-50625 the Solution in case of High Electrical Disturbed Environment

This unit converts the standard Mod-Bus communication from RS485 wired to fibre-optic type with the aim to increase the communication distance and provide an extremely high communication immunity in case of combined centralised inverters, String monitor devices and stringMoni® server or other equivalent devices.

Overall features

- RS485 to glass fibre optic adaptor.
- Dual way communication capability (wire to fibre optics and fibre optics to wire).
- Fibre optic single loop communication (cascade connection: communication loss in case of loop cut).
- Fibre optic dual loop communication (dual cascade connection: partial communication loss in case of one loop cut).
- Fibre optic dual loop communication (redundant communication: no communication loss in case of one loop cut).
- 10 to 24VDC/12 to 18VAC power supply.
- DIN-rail mounting type.

Fibre type and communication distances

- Single-mode and multi-mode glass fibre optic compatibility.
- Point to point distance up to 800m with 50/125 µm multi-mode fibre.
- Point to point distance up to 2000m with 62.5/125 µm multi-mode fibre.



The stringMoni® comprehensive Monitoring Solution

Increase the security of your PV plant adding the specific stringMoni® antitheft solution



stringMoni®, in addition to all its remarkable features can also be provided with an anti-theft system which allows you to protect the whole PV installation, particularly when it is a ground mounted type. This security system is based on a cost effective plastic fibre optic technology which is easy to install and doesn't need expensive and specific fibre optic mounting skills. The optical sensing part is represented by VIM-AT which provides a theft alarm as soon as the plastic fibre, in its sensing loop, is broken because of PV panel removal attempt.



Fibre optic specific supplied cutter.

VIM-O.AT and VIM-AT overall features

- Every stringMoni® (stringMoni® server) can manage up to 3 VIMAT modules in combination with VIM-O "AT" with one relay output.
- The maximum allowed length of the fibre optic is 200m/ VIM-AT.
- The theft status is managed by the VIM-M unit which transmits the status to management system by means of the RS485 communication port (either wired or glass fibre optic based).
- VIM-AT sensor power supply from stringMoni® solution
- PFO22.1000: fibre optic roll of 1000m.

VIM-AT sensors in an stringMoni® context

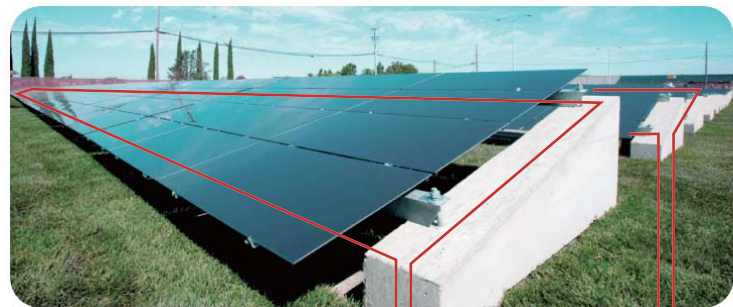

The stringMoni® comprehensive Monitoring Solution

Replacement of standard “positive” fuse holders with same space stringMoni® VIM-M and VIM-S solution providing a cost effective control without need of replacement of existing stringMoni® server. Full local variable measurement with data and local switch disconnecter trip alarm and surge protection status logging for an efficient and effective string and plant local and remote monitoring and control. String box with switch disconnecter, surge and fuses protection with measurements of V-A-kW-kWh (VIM-S), cell-air temperatures-irradiation-wind speed (VIM-P) and extended control features (VIM-O).

Existing stringMoni® server

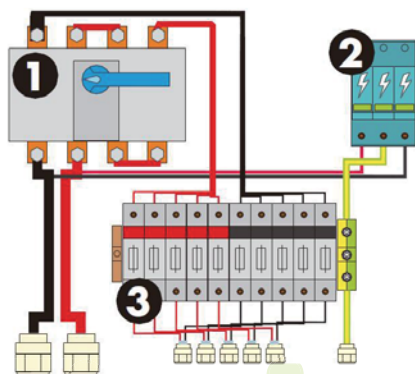

stringMoni® server with switch disconnecter, surge and fuses protection.

Benefits

Apparently cheap solution, which becomes very expensive, in a large installation, because of the long fault searching time and the relevant missed production.

1. DC switch disconnecter
2. Surge arrester
3. Fuses

Examples of stringMoni® server main pages

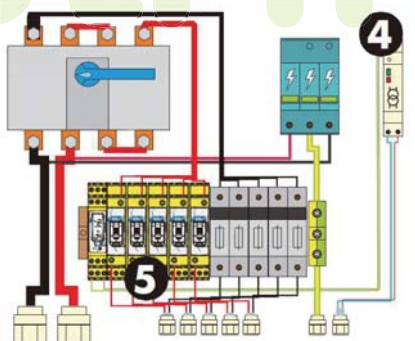

stringMoni® with switch disconnecter, surge and fuses protection with added measurement features.

Benefits

Replacement of standard “positive” fuse holders with same space String monitor VIM-M/ML and VIM-S/S0 solution providing a cost effective control without need of replacement of existing string box.

4. Power supply
5. stringMoni® or stringMoni® Lite

Advanced stringMoni® server with Master function and Web-server capability

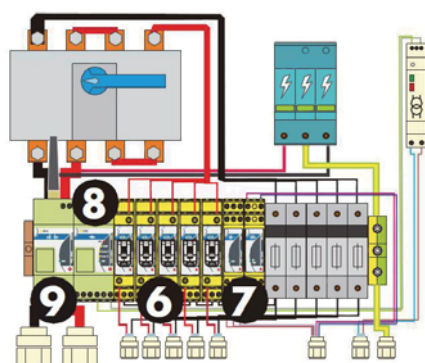

Master stringMoni® with switch disconnecter, surge and fuses protection with measurements of V-A-kW-kWh VIM-S, cell-air temperatures, irradiation, wind speed VIM-P and extended control features (VIM-O) and integrated master and web-server capability.

Benefits

Full local variable measurement with data, protection-trip alarms and surge protection status logging for an efficient and effective string and plant remote internet access monitoring and control.

6. stringMoni® Anti-theft
7. VIM-C - Web-Server
8. VIM-W - Mobile modem

Compare and refine your investment

The main differences between the two monitoring solutions

Modules	Function and Features	stringMoni®-web Lite	stringMoni®-web
All	Modular concept	✓	✓
VIM-C	Master unit with 12 to 28VDC power supply	✓	✓
	Web-Server and Web-Service capability (XML)	Only Web-Service	✓
	One RS485 com port for up to 10+1 String monitor/Lite systems	✓	✓
	One RS485 com port for up to 10+1 Inverters/Energy meters	✓	✓
	High speed USB 2.0 "Host" port + one mini USB "Device" port	Only mini USB	✓
	Back-up memory: micro SD/SDHC type up to 16GB		✓
VIM-W	All data and event logger with most popular spread-sheet download capability	Limited	✓
	Functions: total string-Zone-BOS efficiencies, PR and yield indices		✓
	Mobile modem: GSM, GPRS, EDGE, UMTS, HSPA (mini SIM)	✓	✓
	Automatic dual or quad band setting (850-900Mhz, 1800-1900/2100Mhz)	✓	✓

Modules	Function and Features	stringMoni® Lite	stringMoni®
VIM-M "Local Bus Manager"	12 to 28VDC power supply	✓	✓
	Local display with programming pushbutton	✓	✓
	Measurement of single string current from VIM-S only	✓	✓
	Alarm management on measured variables	✓	✓
	Current string monitoring	✓	✓
	Power string monitoring		✓
	String efficiency		✓
	Event-logger: variables, functions and system alarms		✓
	Data-logger: V, A, W, Wh, PV cell temperature, air temp., irradiation		✓
	Two temperature inputs: Pt100/Pt1000 or one energy counting input		✓
	Clock		✓
VIM-P	Irradiation sensor input: max. 120mV or 20mA	✓	✓
	Two temperature probe inputs: Pt100/Pt1000 (3-wire)	Only one input	✓
	Short/open circuit on probe inputs diagnostics	✓	✓
VIM-S "String Controller"	Wind speed sensor measuring input (pulse)		✓
	Local status monitoring by means of LED		✓
	6-DGT data format for energy		✓
	4-DGT data format for instantaneous variables	✓	✓
	Integrated fuse holder	✓	✓
	String voltage measurement up to 1000V (±0.5% RDG)	✓	✓
	String current measurement up to 14A@55°C (±0.5% RDG)	✓	✓
	String current measurement up to 30A@55°C (±0.5% RDG)	✓	✓
	String power measurement (±1.0% RDG)		✓
	String energy measurement (class 1)		✓
VIM-O	Fuse blow alarm	✓	✓
	Fuse temperature alarm	✓	✓
	Wrong connection (reverse current or voltage) detection	✓	✓
	Two relay outputs activated by local alarm or as remote control	Only one output	✓
All	Two digital inputs (for trip protection detection or other purpose)		✓
	VIM-AT: three digital inputs and one alarm relay output		✓
	Antitheft control combined with VIM-O.AT three digital inputs unit		✓

Compare and refine your investment

The main differences between the two monitoring solutions

Modules	Function and Features	stringMoni® Lite	stringMoni®
All	Modular concept	✓	✓
VIM-M Units Manager	12 to 28VDC power supply	✓	✓
	RS485 communication port (max. 115.2 kbit/s)	✓	✓
	Programming of communication speed and address	✓	✓
	Local display with programming pushbutton	✓	✓
	Measurement of single current from VIM-S only	✓	✓
	Alarm management on measured variables	✓	✓
	Local bus-configuration errors control	✓	✓
	Current string monitoring	✓	✓
	Power string monitoring		✓
	String efficiency		✓
	Event-logger: variables, functions and system alarms		✓
	Data-logger: V, A, W, Wh, PV cell temperature, air temperature, irradiation		✓
	First digital input (energy counting)		✓
	First temperature input or temperature input: Pt100/Pt1000 (2 or 3 wire)		✓
	Second digital input or temperature input: Pt100/Pt1000 (2 or 3 wire)		✓
Clock		✓	
VIM-S String Control Unit	Local status monitoring by means of LED		✓
	6-DGT data format for energy		✓
	4-DGT data format for instantaneous variables		✓
	Integrated fuse holder (not available for 30A string input)	✓	✓
	String voltage measurement up to 1000VDC (+/-) (0.5% RDG)	✓	✓
	String current measurement up to 16ADC (0.5% RDG)	✓	✓
	String current measurement up to 30ADC (0.5% RDG)	✓	✓
	String power measurement (1.0% RDG)		✓
	String energy measurement (class 1)		✓
	Fuse blow alarm		✓
	Fuse temperature alarm	✓	✓
Wrong connection (reverse current or voltage)	✓	✓	
VIM-1	Isolation-enhancement unit which increases the string input to earth voltage from 800VDC to 1000VDC	✓	✓
VIM-P Environment Measuring unit	Irradiation sensor input: max. 120mV or max. 20mA DC	✓	✓
	First temperature probe input: Pt100/Pt1000 (2 or 3-wire)	✓	✓
	Short/open circuit on probe inputs	✓	✓
	Second temperature probe input: Pt100/Pt1000 (2 or 3-wire)		✓
VIM-O Inputs / Outputs unit	Wind speed sensor measuring input		✓
	First relay output activated by local alarm	✓	✓
	First relay output managed as remote command		✓
	Second relay output activated by local alarm		✓
	Second relay output managed as remote command		✓
VIM-ANTI Antitheft control	First digital input		✓
	Second digital input		✓
	Antitheft control based on fibre optic		✓
	Up to 3 fibre optic sensors (200m each loop)		✓
	VIM-O-ANTI I/O unit (3 digital inputs/one relay output) for VIM-ANTI sensor		✓



stringMoni[®]

JDA 日燭科技有限公司
JD Auspice Co., Ltd

JD Auspice Co.,Ltd.

Register : 3F., No.288, Sec. 2, Zhonghua Rd.,
Xinzhuang Dist., New Taipei City 242, Taiwan R.O.C.

www.jdauspice.com

service@jdauspice.com

TEL : +886-2-8991-2796

FAX : +886-2-8991-9298