

PV40-1000-MVCR

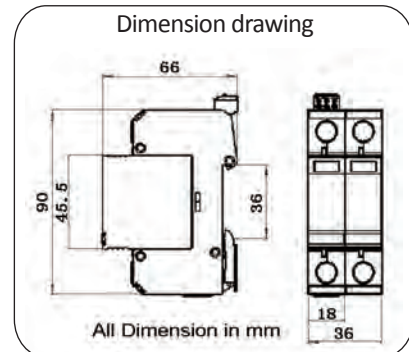
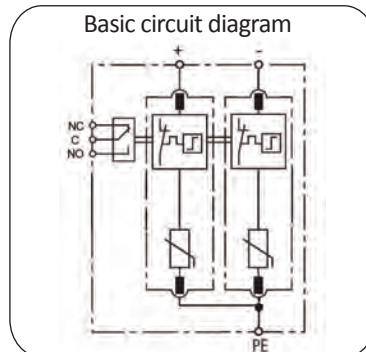

Type 2 SPD designed for low voltage system protection against surges at the boundaries from lightning protection zone 1-2 and higher.

- ⊙ Class II surge protector for Photovoltaic system
- ⊙ IEC61643-31, EN50539 compliance
- ⊙ Type 2, common mode surge protection, 40kA surge arrester
- ⊙ Pluggable design SPD, easy replacement
- ⊙ Reliable supervision due to disconnection device
- ⊙ Fault indication by red indication flag in window
- ⊙ With remote alarm terminal optional

Part No.	PV40/1000-MVCR	
In accordance with	IEC61643-31, EN50539	
Category IEC/VDE	II/ C	
Protection Mode	Common mode	
Nominal voltage (Vdc)	Un	1000
Max. continuous operating voltage (Vdc)	Ucpv	1060
Nominal discharge current(8/20)	In	20kA
Max. discharge current(8/20)	Imax	40kA
Voltage protection rating	Up	<3.6kV
Short-circuit current rating(Iscpv)	100A	
Response time	≤ 25ns	
Follow current	No	
Backup fuse(only required if not already provided in mains)	125A gR/gPV	
Operating temperature range	- 40°C ~ + 80°C	
Cross-section of connection wire	Single-strand 35mm ² ; multi-strand 25mm ²	
Mounting	35mm DIN-rail in accordance with EN 50022/DIN46277-3	
Enclosure material	thermoplastic; extinguishing degree UL94 V-0	
Degree of protection	IP20	
Installation width	2 modules, DIN 43880	
Thermal disconnecter	Internal green – normal ; red - failure	
Remote alarm contact	Optional	
Approvals, Certifications	CE	
Remote alarm contact type	Isolated Form C	
Switching capability Un/In	AC: 250V/0.5A DC: 250V/0.1A; 125V/0.2A; 75V/0.5A	
Max. Size of connecting wire	Max. 1.5mm ² (or # 16AWG)	

Note: Subject to change without any notice.