

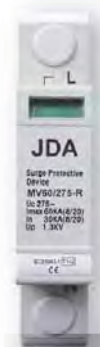

Surge Protection

太陽能 電力 通訊 突波保護

- DC SPD for PV System
- SPD for Power Supply
- Data Network Protector
- Modular Thermally Protected MOV

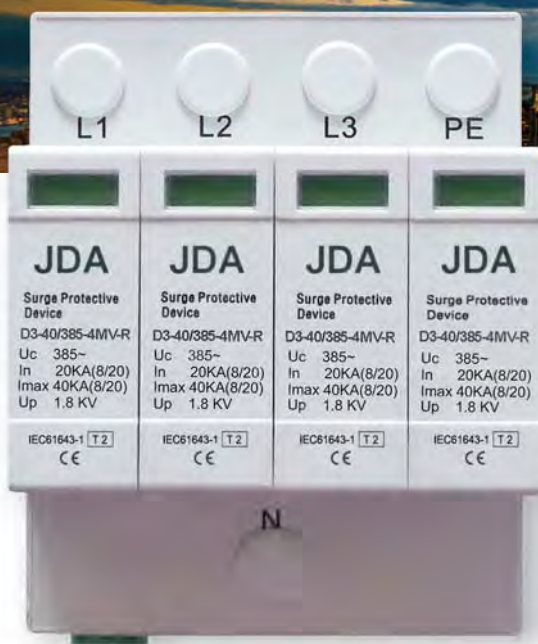



Contents

頁次Page

Type designation	-----	
型號名稱		03

Surge protection for PV Industry	-----	
太陽能專用突波保護器		04 - 09

Surge protection for Low-Voltage Power Supply Systems

低壓系統突波保護器	MOV&GDT in series	
	Single Phase D1-&&/***-VG-R	10 - 17
	Three Phase D3-&&/***-3VG-R	18 - 25
	Single Pole MVGT&&/***-R	26 - 31
	MOV mouldle	
	Single Phase D1-&&/***-2MV-R	32 - 39
	Three Phase D3-&&/***-4MV-R	40 - 47
	Single Pole MV&&/***-R	48 - 56
	Multi-Air-Gap series	
	SG&&/***	57 - 58
	Spark gap series	
	SG50/*** . SG100/***	59
	GDT mouldle	
	GT&&/***	60 - 68

Surge protection for Network Signaling and Data Line

網路及訊號用突波保護器	Data Network protector	
	DN-*/B0	69

Passive Lightning Event CountType surgeCon SEC

雷擊計數器		70
-------	--	-----------

Surge protective device wiring

突波保護接線示意圖	-----	71 - 74
-----------	-------	----------------





Type Designation on SPD/TVSS for Low Voltage Power Supply Din Rail SPD

Single Pole

Spark Gap Type

SG&& / xxx

SG – Spark Gap Type

&& – Iimp value (10/350)

xxx – Max. continuous operating voltage Uc

GDT Type

GT&& / xxx-R

GT – Gas Discharge Tube (GDT) Type

&& – Max. discharge current I_{max} (8/20)

xxx – Max. continuous operating voltage Uc

R – With remote Signal

MOV Type

MV&& / xxx-R

MV – Metal Oxide Varistor Module

&& – Max. discharge current I_{max} (8/20)

xxx – Max. continuous operating voltage Uc

R – With remote Signal

MOV&GDT in series Type

MVGT&& / xxx-R

MVGT – Metal Oxide Varistor & Gas Discharge Tube in series

&& – Max. discharge current I_{max} (8/20)

xxx – Max. continuous operating voltage Uc

R – With remote Signal

PV SPD

PV&& / xxx -MVCDR

PV – Photo Voltaic

&& – Max. discharge current I_{max} (8/20)

xxx – Nominal voltage (V)U_N

MV – Metal Oxide Varistor Module

C – Common mode

D – Differential mode

R – With remote Signal

PV&& / xxx -MVGT-CD-R

PV – Photo Voltaic

&& – Max. discharge current I_{max} (8/20)

xxx – Nominal voltage (V) U_N

MVGT – Metal Oxide Varistor & Gas Discharge Tube in series

C – Common mode

D – Differential mode

R – With remote Signal

Single Phase

D1&& / xxx-*-R**

D1 – Din Rail SPD Single phase

&& – Max. discharge current I_{max} (8/20)

xxx – Max. continuous operating voltage Uc

*** – Modules combination

R – With remote Signal

Three Phase

D3&& / xxx-*-R**

D3 – Din Rail SPD Three phase

&& – Max. discharge current I_{max} (8/20)

xxx – Max. continuous operating voltage Uc

*** – Modules combination

R – With remote Signal

DC Surge Protective Devices for Photo-Voltaic protection(PV Industry) Type PV 40/500-MVCR

Common mode DC Surge arrester for Photovoltaic protection against surges at the boundaries from lightning protection zone 0B-1 and higher.

DC Surge Protective Device for PV

- Class II (C) DC arrester in according with IEC61643-1:2005.
- Two part design consisting of base and plug-in protection module.
- Common protection mode.
- High energy MOV (Metal Oxide Varistor) inside.
- Reliable supervision due to disconnection device.
- Fault indication by red indication flag in window.
- Fast response.
- With remote alarm terminal.

Rapid thermal disconnection under TOV ; Inbuilt Arc - extinguishing device.



Characteristics

Type	PV 40 / 500 - MVCR
In accordance with	IEC61643-1:2005; UL1449 ed.3
Category IEC/VDE	II/C
Protection Mode	Common mode
Nominal Voltage (DC)	500VDC
Max. continuous operating voltage (DC)	530VDC
Nominal discharge current (8/20) In	20KA
Max. discharge current(8/20) Imax	40KA
Voltage protection level @ In	1.6KV
VPR at 6KV/3KA	<2KV
Response time	≤25 ns
Backup fuse(only required if not already provided in mains)	125A gL/gG
Operating temperature range	- 40°C + 80°C
Cross-section of connection wire	Single-strand 35mm ² ; multi-strand 25mm ²
Mounting	35mm DIN-rail in accordance with EN 50022/DIN46277-3
Enclosure material	thermoplastic; extinguishing degree UL94 V-0
Degree of protection	IP20
Installation width	2 module, DIN 43880
Thermal disconnector	Internal green – normal red - failure
Remote alarm contact	Yes
Additional data for Remote Alarm Contacts	
Remote alarm contact type	floating changeover contact
Switching capability UN/IN	AC: 250V/0.5A DC: 250V/0.1A; 125V/0.2A; 75V/0.5A
Cross-section of connection wire	Max. 1.5mm ²

Dimensions and Diagram

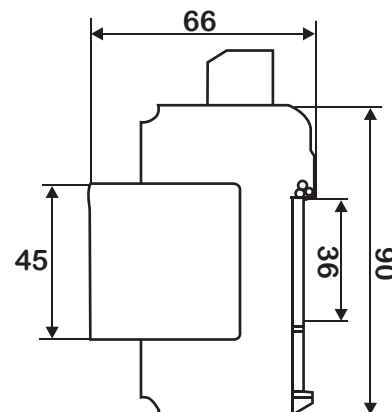
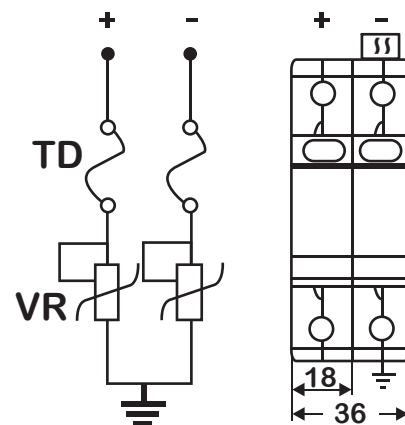

All dimension in mm

Note: Subject to change without any notice.

DC Surge Protective Device for PV Type PV 40/600-MVCR

Common mode DC Surge arrester for Photovoltaic protection against surges at the boundaries from lightning protection zone 0B-1 and higher.

DC Surge Protective Device for PV

- Class II (C) DC arrester in according with IEC61643-1:2005.
- Two part design consisting of base and plug-in protection module.
- Common protection mode.
- High energy MOV (Metal Oxide Varistor) inside.
- Reliable supervision due to disconnection device.
- Fault indication by red indication flag in window.
- Fast response.
- With remote alarm terminal optional.

Rapid thermal disconnection under TOV ;
Inbuilt Arc - extinguishing device.



Characteristics

Type	PV 40 / 600 - MVCR
In accordance with	IEC61643-1:2005 ; UL1449 ed.3
Category IEC/VDE	II / C
Protection Mode	Common mode
Nominal voltage	600VDC
Max. continuous operating voltage (DC)	670VDC
Nominal discharge current (8/20) In	20KA
Max. discharge current(8/20) Imax	40KA
Voltage protection level	2.2KV
Response time	≤25 ns
Backup fuse (only required if not already provided in mains)	125A gL/gG
Operating temperature range	- 40°C + 80°C
Cross-section of connection wire	Single-strand 35mm ² ; multi-strand 25mm ²
Mounting	35mm DIN-rail in accordance with EN 50022/DIN46277-3
Enclosure material	Thermoplastic ; extinguishing degree UL94 V-0
Degree of protection	IP20
Installation width	2 module , DIN 43880
Thermal disconnecter	Internal green – normal red - failure
Remote alarm contact	Optional
Additional data for Remote Alarm Contacts	
Remote alarm contact type	floating changeover contact
Switching capability UN/IN	AC: 250V/0.5A DC: 250V/0.1A ; 125V/0.2A ; 75V/0.5A
Cross-section of connection wire	Max. 1.5mm ²

Dimensions and Diagram

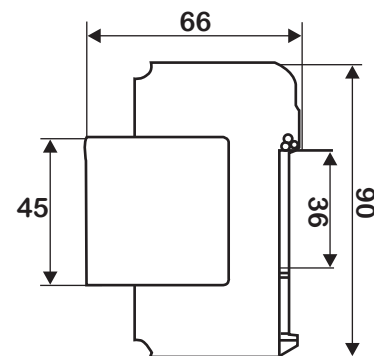
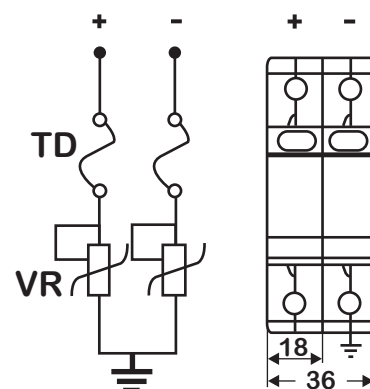

All dimension in mm

Note: Subject to change without any notice.

DC Surge Protective Devices for Photo-Voltaic protection(PV Industry) Type PV 40/500-MVCDR

Differential and common mode DC Surge arrester for Photovoltaic protection against surges at the boundaries from lightning protection zone 0B-1 and higher.

- Class II (C) DC arrester in according with IEC61643-1:2005.
- Two part design consisting of base and plug-in protection module.
- Differential and common protection mode.
- High energy MOV (Metal Oxide Varistor) inside.
- Reliable supervision due to disconnection device.
- Fault indication by red indication flag in window.
- Fast response.
- With remote alarm terminal optional.

Rapid thermal disconnection under TOV ;
Inbuilt Arc - extinguishing device.



Characteristics

Type	PV 40 / 500 - MVCDR
In accordance with	IEC61643-1:2005; UL1449 ed.3
Category IEC/VDE	II/ C
Protection Mode	Differential mode & Common mode
Nominal Voltage (DC)	500VDC
Max. continuous operating voltage (DC)	530VDC
Nominal discharge current (8/20) In	20KA
Max. discharge current(8/20) Imax	40KA
Voltage protection level @ In	1.8KV
Response time	≤25 ns
Backup fuse(only required if not already provided in mains)	125A gL/gG
Operating temperature range	- 40°C + 80°C
Cross-section of connection wire	Single-strand 35mm ² ; multi-strand 25mm ²
Mounting	35mm DIN-rail in accordance with EN 50022/DIN46277-3
Enclosure material	thermoplastic; extinguishing degree UL94 V-0
Degree of protection	IP20
Installation width	3 module, DIN 43880
Thermal disconnecter	Internal green – normal red - failure
Remote alarm contact	Optional
Additional data for Remote Alarm Contacts	
Remote alarm contact type	floating changeover contact
Switching capability UN/IN	AC: 250V/0.5A DC: 250V/0.1A; 125V/0.2A; 75V/0.5A
Cross-section of connection wire	Max. 1.5mm ²

Dimensions and Diagram

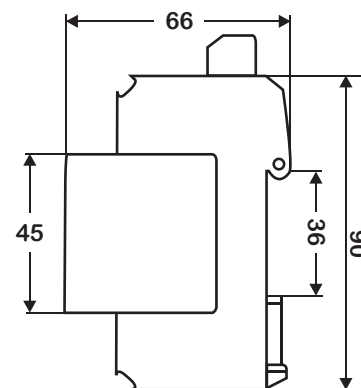
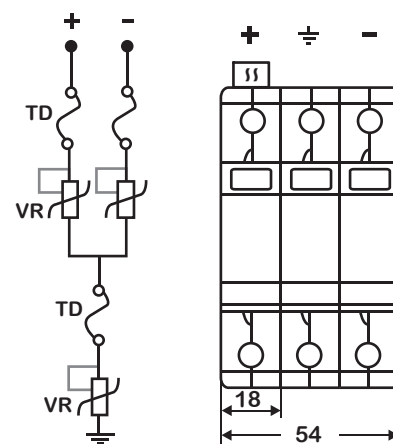

All Dimensions in mm

Note: Subject to change without any notice.

DC Surge Protective Device for PV Type PV 40/750-MVCDR

Differential and common mode DC Surge arrester for Photovoltaic protection against surges at the boundaries from lightning protection zone 0B-1 and higher.

- Class II (C) DC arrester in according with IEC61643-1:2005.
- Two part design consisting of base and plug-in protection module.
- Differential and common protection mode.
- High energy MOV (Metal Oxide Varistor) inside.
- Reliable supervision due to disconnection device.
- Fault indication by red indication flag in window.
- Fast response.
- With remote alarm terminal optional.

Rapid thermal disconnection under TOV ;
Inbuilt Arc - extinguishing device.

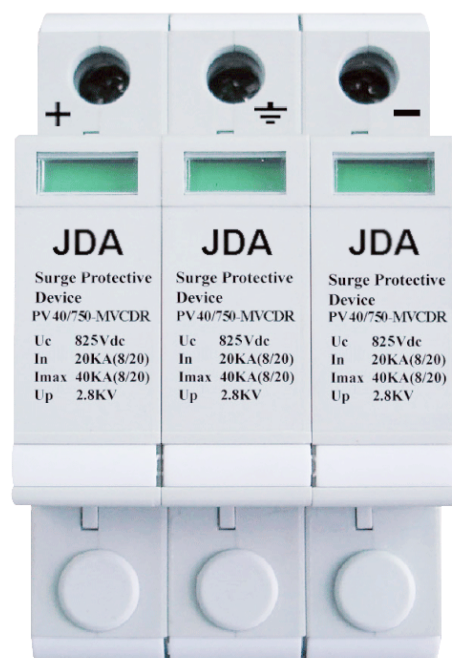

Characteristics

Type	PV 40 / 750 - MVCDR
In accordance with	IEC61643-1:2005 ; UL1449 ed.3
Category IEC/VDE	II/ C
Protection Mode	Differential mode & Common mode
Nominal voltage	750VDC
Max. continuous operating voltage (DC)	825VDC
Nominal discharge current (8/20) In	20KA
Max. discharge current(8/20) I _{max}	40KA
Voltage protection level	2.8KV
Response time	≤25 ns
Backup fuse(only required if not already provided in mains)	125A gL/gG
Operating temperature range	- 40°C + 80°C
Cross-section of connection wire	Single-strand 35mm ² ; multi-strand 25mm ²
Mounting	35mm DIN-rail in accordance with EN 50022/DIN46277-3
Enclosure material	Thermoplastic ; extinguishing degree UL94 V-0
Degree of protection	IP20
Installation width	3 modules , DIN 43880
Thermal disconnecter	Internal green – normal red - failure
Remote alarm contact	Optional
Additional data for Remote Alarm Contacts	
Remote alarm contact type	floating changeover contact
Switching capability UN/IN	AC: 250V/0.5A DC: 250V/0.1A ; 125V/0.2A ; 75V/0.5A
Cross-section of connection wire	Max. 1.5mm ²

Dimensions and Diagram

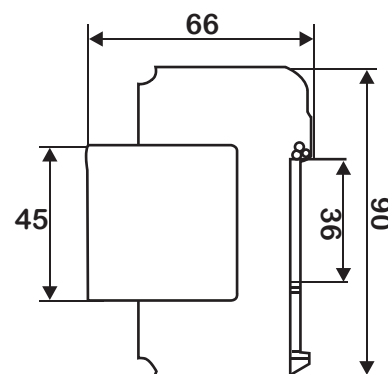
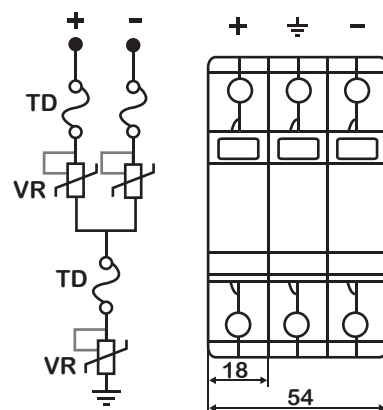

All Dimensions in mm

Note: Subject to change without any notice.

DC Surge Protective Devices for Photo-Voltaic protection(PV Industry) Type PV 40/1000-MVCDR

Common mode DC Surge arrester for Photovoltaic protection against surges at the boundaries from lightning protection zone 0B-1 and higher.

DC Surge Protective Device for PV

- Class II (C) DC arrester in according with IEC61643-1:2005.
- Two part design consisting of base and plug-in protection module.
- Differential and common protection mode.
- High energy MOV (Metal Oxide Varistor) inside.
- Reliable supervision due to disconnection device.
- Fault indication by red indication flag in window.
- Fast response.
- With remote alarm terminal.

Rapid thermal disconnection under TOV ;
Inbuilt Arc - extinguishing device.

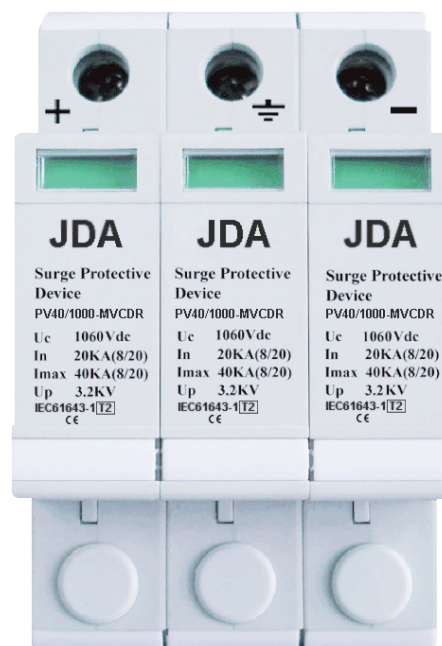

Characteristics

Type	PV 40 / 1000 - MVCDR
In accordance with	IEC61643-1:2005; UL1449 ed.3
Category IEC/VDE	II/ C
Protection Mode	Differential mode & Common mode
Nominal Voltage (DC)	1000VDC
Max. continuous operating voltage (DC)	1060V
Nominal discharge current (8/20) In	20KA
Max. discharge current(8/20) Imax	40KA
Voltage protection level @ In	3.2KV
VPR at 6KV/3KA	<2KV
Response time	≤25 ns
Backup fuse(only required if not already provided in mains)	125A gL/gG
Operating temperature range	- 40°C + 80°C
Cross-section of connection wire	Single-strand 35mm ² ; multi-strand 25mm ²
Mounting	35mm DIN-rail in accordance with EN 50022/DIN46277-3
Enclosure material	thermoplastic; extinguishing degree UL94 V-0
Degree of protection	IP20
Installation width	3 module, DIN 43880
Thermal disconnecter	Internal green – normal red - failure
Remote alarm contact	yes
Additional data for Remote Alarm Contacts	
Remote alarm contact type	floating changeover contact
Switching capability UN/IN	AC: 250V/0.5A DC: 250V/0.1A; 125V/0.2A; 75V/0.5A
Cross-section of connection wire	Max. 1.5mm ²

Dimensions and Diagram

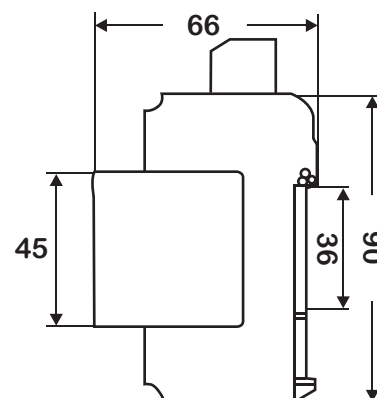
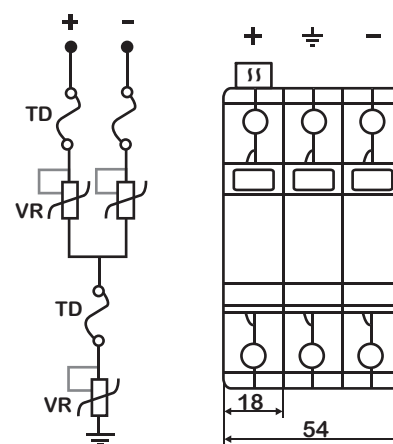

All dimension in mm

Note: Subject to change without any notice.

DC Surge Protective Devices for Photo-Voltaic protection(PV Industry) Type PV 80/1000-MVCDR

Differential and common mode DC Surge arrester for Photovoltaic protection against surges at the boundaries from lightning protection zone 0B-1 and higher.

DC Surge Protective Device for PV

- Class I (B) DC arrester in according with IEC61643-1:2005.
- Two part design consisting of base and non-pluggable protection module.
- Differential and common protection mode.
- High energy MOV (Metal Oxide Varistor) inside.
- Reliable supervision due to disconnection device.
- Fault indication by red indication flag in window.
- Fast response.
- With remote alarm terminal.



Characteristics

Type	PV 80 / 1000 - MVCDR
In accordance with	IEC61643-1:2005; UL1449 ed.3
Category IEC/VDE	I+II/ B+C
Protection Mode	Differential mode & Common mode
Nominal Voltage (DC)	1000VDC
Max. continuous operating voltage (DC)	1060V
Nominal discharge current (8/20) In	40KA
Max. discharge current(8/20) Imax	80KA
Voltage protection level @ In	3.2 KV
VPR at 6KV/3KA	<2KV
Response time	≤25 ns
Backup fuse(only required if not already provided in mains)	250A gL/gG
Operating temperature range	- 40°C + 80°C
Cross-section of connection wire	Single-strand 35mm ² ; multi-strand 25mm ²
Mounting	35mm DIN-rail in accordance with EN 50022/DIN46277-3
Enclosure material	thermoplastic; extinguishing degree UL94 V-0
Degree of protection	IP20
Installation width	6 module, DIN 43880
Thermal disconnecter	Internal green – normal red - failure
Remote alarm contact	Yes
Additional data for Remote Alarm Contacts	
Remote alarm contact type	floating changeover contact
Switching capability UN/IN	AC: 250V/0.5A DC: 250V/0.1A; 125V/0.2A; 75V/0.5A
Cross-section of connection wire	Max. 1.5mm ²

Dimensions and Diagram

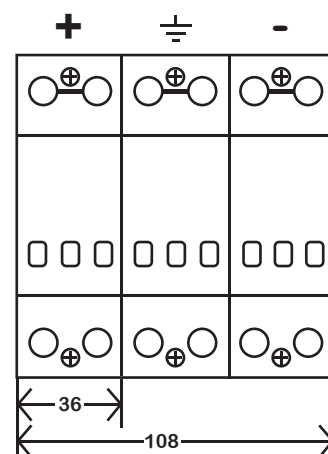
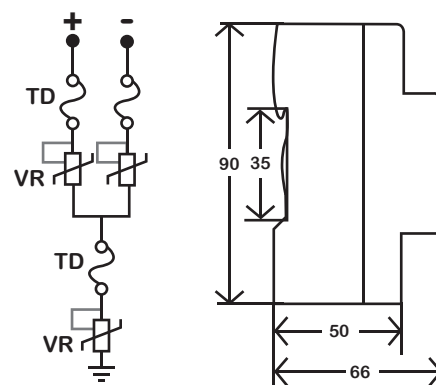

All Dimensions in mm

Note: Subject to change without any notice.

Single Phase (1 MOV& 1GDT Modules) Surge Protection Devices Type D1-25/***-VG-R

Surge arrester for low-voltage power supply system protection against surges at the boundaries from lightning protection zone 0B-1 and higher.

- Class II (C) arrester in according with IEC61643-1:2005.
- Two part design consisting of base and plug-in protection module.
- High energy MOV (Metal Oxide Varistor) and GDT (Gas Discharge Tube) inside.
- Reliable supervision due to disconnection device.
- Fault indication by red indication flag in window.
- Fast response.
- With remote alarm terminal optional.

Rapid thermal disconnection under TOV ;
Inbuilt Arc - extinguishing device.



Characteristics

Type	D1-25/***-VG-R										
	75	150	175	275	300	320	385	440	550	600	
In accordance with	IEC61643-1:2005 ; UL1449 3rd										
Category IEC / VDE	II / C										
Max. continuous operating voltage (AC/DC)	L - N	75/100	150/200	175/225	275/300	300/385	320/420	385/505	440/585	550/745	600/800
	N - PE U _c	65	150	150	255	255	255	255	350	440	440
Nominal discharge current(8/20) I _n	L-N	10KA									
	N-PE	10KA									
Max. discharge current(8/20) I _{max}	L-N	25KA									
	N - PE	25KA									
Voltage	L-N@I _n	0.4KV	0.8KV	0.8KV	1.3KV	1.5KV	1.5KV	1.8KV	2.0KV	2.5KV	2.6KV
	L-N@3KA	0.25KV	0.5KV	0.6KV	0.9KV	1.0KV	1.1KV	1.3KV	1.5KV	2.0KV	2.0KV
protection level	N-PE(1.2/50)	0.5KV	0.8KV	0.8KV	1.0KV	1.0KV	1.0KV	1.0KV	1.2KV	1.3KV	1.3KV
Response time	L-N	≤25 ns									
	N-PE	≤100 ns									
Follow current	L-N	No									
	N-PE	100Arms @ U _c									
Backup fuse		100A gL/gG									
(only required if not already provided in mains)											
Operating temperature range		- 40°C~ + 80°C									
Cross-section of connection wire		Single-strand 35mm ² ; multi-strand 25mm ²									
Mounting		35mm DIN-rail in accordance with EN 50022 / DIN46277-3									
Enclosure material		Thermoplastic ; extinguishing degree UL94 V-0									
Degree of protection		IP20									
Installation width		2 modules , DIN 43880									
Thermal disconnecter		Internal green - normal red - failure									
Remote alarm contact		Optional									

Dimensions and Diagram

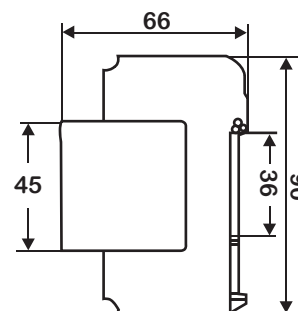
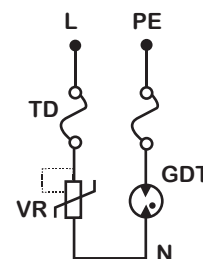

All dimension in mm

Note: Subject to change without any notice.

Single Phase (1 MOV& 1GDT Modules) Surge Protection Devices Type D1-40/***-VG-R

Surge arrester for low-voltage power supply system protection against surges at the boundaries from lightning protection zone 0B-1 and higher.

Single Phase (1 MOV& 1GDT Modules) Surge Protection Devices

- Class II (C) arrester in according with IEC61643-1:2005.
- Two part design consisting of base and plug-in protection module.
- High energy MOV (Metal Oxide Varistor) and GDT (Gas Discharge Tube) inside.
- Reliable supervision due to disconnection device.
- Fault indication by red indication flag in window.
- Fast response.
- With remote alarm terminal optional.

Rapid thermal disconnection under TOV ;
Inbuilt Arc - extinguishing device.



Characteristics

Type		D1-40/***-VG-R									
		75	150	175	275	300	320	385	440	550	600
In accordance with		IEC61643-1:2005 ; UL1449 3rd									
Category IEC/VDE		II / C									
Max. continuous operating voltage (AC/DC)	L-N (AC/DC) N-PE Uc	75/100	150/200	175/225	275/300	300/385	320/420	385/505	440/585	550/745	600/800
Nominal discharge current (8/20) In	L-N N-PE	20KA									
Max. discharge current (8/20) Imax	L-N N-PE	40KA									
Voltage	L-N@In	0.5KV	0.8KV	0.8KV	1.4KV	1.5KV	1.6KV	1.8KV	2.2KV	2.8KV	3.0KV
	L-N@3KA	0.3KV	0.5KV	0.6KV	1.0KV	1.0KV	1.1KV	1.3KV	1.5KV	2.0KV	2.0KV
protection level	N-PE (1.250)	0.5KV	0.8KV	0.8KV	1.0KV	1.0KV	1.0KV	1.0KV	1.2KV	1.6KV	1.6KV
	L-N	≤25 ns									
Response time	N-PE	≤100 ns									
	L-N	No									
Follow current	N-PE	100Arms @ Uc									
	Backup fuse	125A gL/gG									
<small>(only required if not already provided in mains)</small>											
Operating temperature range		- 40°C~ + 80°C									
Cross-section of connection wire		Single-strand 35mm ² ; multi-strand 25mm ²									
Mounting		35mm DIN-rail in accordance with EN 50022/DIN46277-3									
Enclosure material		Thermoplastic ; extinguishing degree UL94 V-0									
Degree of protection		IP20									
Installation width		2 modules , DIN 43880									
Thermal disconnecter		Internal green – normal red - failure									
Remote alarm contact		Optional									

Dimensions and Diagram

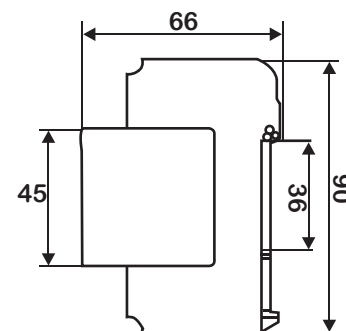
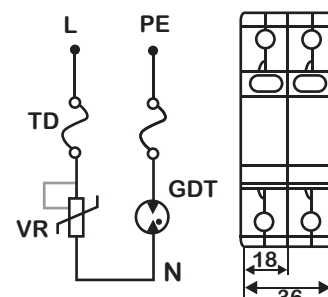

All dimension in mm

Note: Subject to change without any notice.

Single Phase (1 MOV& 1GDT Modules) Surge Protection Devices Type D1-50/***-VG-R

Surge arrester for low-voltage power supply system protection against surges at the boundaries from lightning protection zone 0B-1 and higher.

- Class II (C) arrester in according with IEC61643-1:2005.
- Two part design consisting of base and plug-in protection module.
- High energy MOV (Metal Oxide Varistor) and GDT (Gas Discharge Tube) inside.
- Reliable supervision due to disconnection device.
- Fault indication by red indication flag in window.
- Fast response.
- With remote alarm terminal optional.

Rapid thermal disconnection under TOV ;
Inbuilt Arc - extinguishing device.



Characteristics

Type		D1-50/***-VG-R									
		75	150	175	275	300	320	385	440	550	600
In accordance with		IEC61643-1:2005 ; UL1449 3rd									
Category IEC/VDE		II / C									
Max. continuous operating voltage (AC/DC)	L - N	75/	150/	175/	275/	300/	320/	385/	440/	550/	600/
(AC/DC)	N - PE U _c	65	150	150	255	255	255	255	350	440	440
Nominal discharge current(8/20) I _n	L-N	20KA	20KA	20KA	20KA	20KA	20KA	20KA	20KA	20KA	20KA
	N-PE	20KA	20KA	20KA	20KA	20KA	20KA	20KA	20KA	20KA	20KA
Max. discharge current(8/20) I _{max}	L-N	50KA									
	N - PE	50KA									
	L-N@I _n	0.5KV	0.8KV	0.8KV	1.4KV	1.5KV	1.6KV	1.8KV	2.2KV	2.8KV	3.0KV
Voltage protection level	L-N@3KA	0.3KV	0.5KV	0.6KV	1.0KV	1.0KV	1.1KV	1.3KV	1.5KV	2.0KV	2.0KV
	N-PE(1.2/50)	0.5KV	0.8KV	0.8KV	1.0KV	1.0KV	1.0KV	1.0KV	1.2KV	1.6KV	1.6KV
	L-N	≤25 ns									
Response time	L-PE	≤100 ns									
	L-N	No									
Follow current	L-PE	100Arms @ U _c									
	Backup fuse	125A gL/gG									
(only required if not already provided in mains)											
Operating temperature range		- 40°C~+ 80°C									
Cross-section of connection wire		Single-strand 35mm ² ; multi-strand 25mm ²									
Mounting		35mm DIN-rail in accordance with EN 50022/DIN46277-3									
Enclosure material		Thermoplastic ; extinguishing degree UL94 V-0									
Degree of protection		IP20									
Installation width		2 modules , DIN 43880									
Thermal disconnecter		Internal green – normal red - failure									
Remote alarm contact		Optional									

Dimensions and Diagram

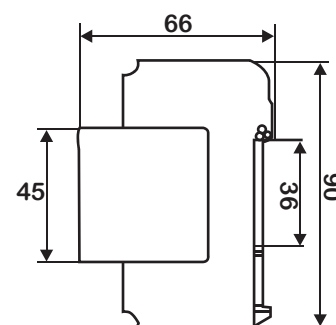
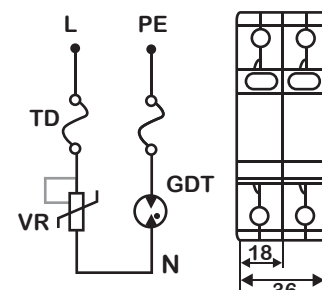

All dimension in mm

Note: Subject to change without any notice.

Single Phase (1 MOV& 1GDT Modules) Surge Protection Devices Type D1-60/***-VG-R

Surge arrester for low-voltage power supply system protection against surges at the boundaries from lightning protection zone 0B-1 and higher.

- Class I+II (B+C) arrester in according with IEC61643-1:2005.
- Two part design consisting of base and plug-in protection module.
- High energy MOV (Metal Oxide Varistor) and GDT (Gas Discharge Tube) inside.
- Reliable supervision due to disconnection device.
- Fault indication by red indication flag in window.
- Fast response.
- With remote alarm terminal.

Rapid thermal disconnection under TOV ;
Inbuilt Arc - extinguishing device.

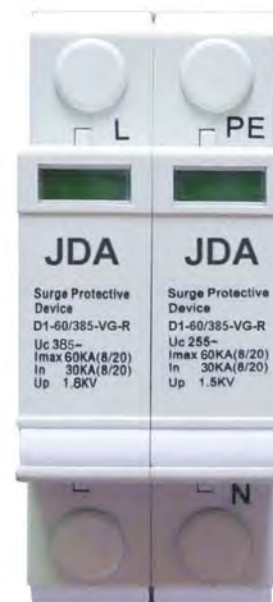

Characteristics

Type		D1-60/***-VG-R									
		75	150	175	275	300	320	385	440	550	600
In accordance with		IEC61643-1:2005 ; UL1449 3rd									
Category IEC / VDE		I+II / B+C									
Max. continuous operating voltage (AC/DC)	L-N(AC/DC)	75 / 100	150/200	175/225	275/300	300/385	320/420	385/505	440/585	550/745	600/800
	N-PE Uc	65	150	150	255	255	255	255	350	440	440
Nominal discharge current (8/20) In	L-N	30KA									
	N-PE	30KA									
Max. discharge current (8/20) Imax	L-N	60KA									
	N-PE	60KA									
Lightning impulse current(10/350) Iimp	L-N	7KA									
	N-PE	15KA									
Voltage	L-N@In	0.5KV	0.8KV	0.8KV	1.3KV	1.4KV	1.5KV	1.8KV	2.2KV	2.8KV	3.0KV
	L-N@3KA	0.3KV	0.5KV	0.6KV	1.0KV	1.0KV	1.1KV	1.3KV	1.5KV	2.0KV	2.1KV
Protection level	N-PE(1,2/50)	0.5KV	0.8KV	0.8KV	1.0KV	1.0KV	1.0KV	1.0KV	1.2KV	1.6KV	1.6KV
	L-N	≤25 ns									
Response time	N-PE	≤100 ns									
	L-N	No									
Follow current	N-PE	If ≥ 100Arms @ Uc									
	Backup fuse	160A gL / gG									
(only required if not already provided in mains)											
Operating temperature range		- 40°C ~ + 80°C									
Cross-section of connection wire		Single-strand 35mm ² ; multi-strand 25mm ²									
Mounting		35mm DIN-rail in accordance with EN 50022 / DIN46277-3									
Enclosure material		Thermoplastic ; extinguishing degree UL94 V-0									
Degree of protection		IP20									
Installation width		2 modules , DIN 43880									
Thermal disconnecter		Internal green – normal red - failure									
Remote alarm contact		Yes									

Dimensions and Diagram

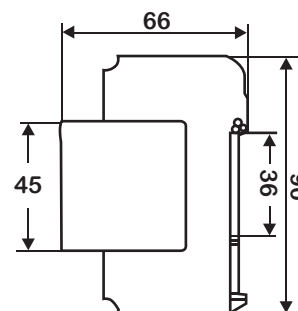
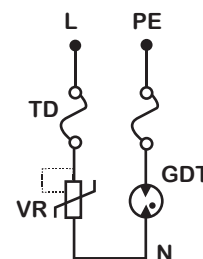

All dimension in mm

Note: Subject to change without any notice.

Single Phase (1 MOV& 1GDT Modules) Surge Protection Devices Type D1-80/***-VG-R

Surge arrester for low-voltage power supply system protection against surges at the boundaries from lightning protection zone 0B-1 and higher.

- Class I+II (B+C) arrester in according with IEC61643-1:2005.
- Two part design consisting of base and non-pluggable protection module.
- High energy MOV (Metal Oxide Varistor) and GDT (Gas Discharge Tube) inside.
- Reliable supervision due to disconnection device.
- Fault indication by red indication flag in window.
- Fast response.
- With remote alarm terminal optional.



Characteristics

Type	D1-80/***-VG-R										
	150	175	275	300	320	385	440	550	600		
In accordance with	IEC61643-1:2005 ; UL1449 3rd										
Category IEC / VDE	I+II / B+C										
Max. continuous operating voltage (AC/DC)	L-N	150/200	175/225	275/300	300/385	320/420	385/505	440/585	550/745	600/800	
	N-PE Uc	150	150	255	255	255	255	350	440	440	
Nominal discharge current(8/20) In	L-N	40KA									
	N-PE	40KA									
Max. discharge current(8/20) Imax	L-N	80KA									
	N-PE	80KA									
Lightning impulse current(10/350) Iimp	L-N	10KA									
	N-PE	25KA									
Voltage protection level	L-N@In	0.8KV	0.8KV	1.3KV	1.4KV	1.5KV	1.8KV	2.1KV	2.8KV	3.0KV	
	L-N@3KA	0.5KV	0.6KV	1.0KV	1.0KV	1.1KV	1.3KV	1.5KV	2.0KV	2.1KV	
	N-PE (1.2/50)	0.8KV	0.8KV	1.0KV	1.0KV	1.0KV	1.0KV	1.2KV	1.6KV	1.6KV	
Response time	L-N	≤25 ns									
	N-PE	≤100 ns									
Follow current	L-N	No									
	N-PE	If ≥ 100Arms @ Uc									
Backup fuse	200A gL/gG										
<small>(only required if not already provided in mains)</small>											
Operating temperature range	- 40°C ~ + 80°C										
Cross-section of connection wire	Single-strand 35mm ² ; multi-strand 25mm ²										
Mounting	35mm DIN-rail in accordance with EN 50022 / DIN46277-3										
Enclosure material	Thermoplastic ; extinguishing degree UL94 V-0										
Degree of protection	IP20										
Installation width	4 modules , DIN 43880										
Thermal disconnecter	Internal green – normal red - failure										
Remote alarm contact	Optional										

Note: Subject to change without any notice.

Dimensions and Diagram

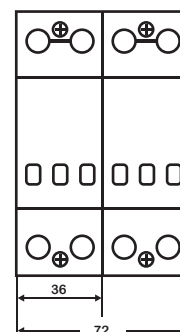
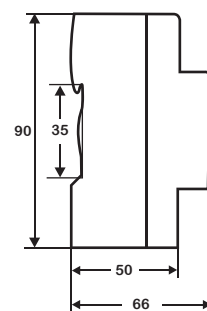
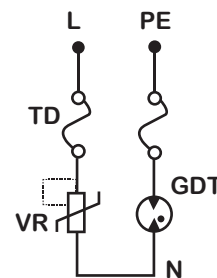

Single Phase (1 MOV& 1GDT Modules) Surge Protection Devices Type D1-100/***-VG-R

Surge arrester for low-voltage power supply system protection against surges at the boundaries from lightning protection zone 0B-1 and higher.

- Class I+II (B+C) arrester in according with IEC61643-1:2005.
- Two part design consisting of base and non-pluggable protection module.
- High energy MOV (Metal Oxide Varistor) and GDT (Gas Discharge Tube) inside.
- Reliable supervision due to disconnection device.
- Fault indication by red indication flag in window.
- Fast response.
- With remote alarm terminal optional.



Characteristics

Type	D1-100/***-VG-R										
	150	175	275	300	320	385	440	550	600		
In accordance with	IEC61643-1:2005 ; UL1449 3rd										
Category IEC / VDE	I+II / B+C										
Max. continuous operating voltage (AC/DC)	L-N (AC/DC)	150/200	175/225	275/300	300/385	320/420	385/505	440/585	550/745	600/800	
	N-PE Uc	150	150	255	255	255	255	350	440	440	
Nominal discharge current(8/20) In	L-N	50KA									
	N-PE	50KA									
Max. discharge current (8/20) I _{max}	L-N	100KA									
	N-PE	100KA									
Lightning impulse current (10/350) I _{imp}	L-N	12.5KA									
	N-PE	25KA									
Voltage protection level	L-N@In	0.8KV	0.8KV	1.3KV	1.4KV	1.5KV	1.8KV	2.1KV	2.8KV	3.0KV	
	L-N@3KA	0.5KV	0.6KV	0.9KV	1.0KV	1.1KV	1.3KV	1.5KV	2.0KV	2.0KV	
	N-PE (1.2/50)	0.8KV	0.8KV	1.2KV	1.2KV	1.2KV	1.2KV	1.4KV	1.6KV	1.6KV	
Response time	L-N	≤25 ns									
	N-PE	≤100 ns									
Follow current	L-N	No									
	N-PE	No									
Backup fuse		250A gL/gG									
<small>(only required if not already provided in mains)</small>											
Operating temperature range		- 40°C ~ + 80°C									
Cross-section of connection wire		Single-strand 35mm ² ; multi-strand 25mm ²									
Mounting		35mm DIN-rail in accordance with EN 50022 / DIN46277-3									
Enclosure material		Thermoplastic ; extinguishing degree UL94 V-0									
Degree of protection		IP20									
Installation width		4 modules , DIN 43880									
Thermal disconnecter		Internal green - normal red - failure									
Remote alarm contact		Optional									

Note: Subject to change without any notice.

Dimensions and Diagram

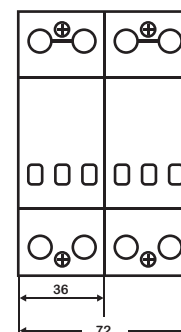
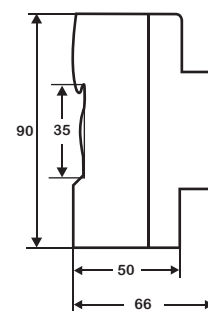
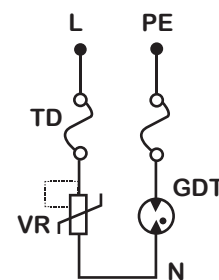

Single Phase (1 MOV& 1GDT Modules) Surge Protection Devices Type D1-120/385-VG-R

Surge arrester for low-voltage power supply system protection against surges at the boundaries from lightning protection zone 0B-1 and higher.

- Class I+ II (B+C) arrester in according with IEC61643-1:2005.
- Two part design consisting of base and non-pluggable protection module.
- High energy MOV (Metal Oxide Varistor) and GDT (Gas Discharge Tube) inside.
- Reliable supervision due to disconnection device.
- Fault indication by red indication flag in window.
- Fast response.
- With remote alarm terminal optional.



Characteristics

Type		D1-120 / 385-VG-R								
		150	175	275	300	320	385	440	550	600
In accordance with		IEC61643-1:2005 ; UL1449 3rd								
Category IEC / VDE		I+II / B+C								
Max. continuous operating voltage (AC/DC)	L – N	150	175	275	300	320	385	440	550	600
	(AC/DC) N – PE Uc	/200	/225	/300	/385	/420	/505	/585	/745	/800
Nominal discharge current (8/20) In	L-N	150	150	255	255	255	255	350	440	440
	N-PE									
Max. discharge current (8/20) Imax	L-N									
	N-PE									
Lightning impulse current (10/350) Iimp	L-N									
	N-PE									
Voltage protection level	L-N@In	0.8KV	0.8KV	1.3KV	1.4KV	1.5KV	1.8KV	2.1KV	2.8KV	3.0KV
	L-N@3KA	0.5KV	0.6KV	0.9KV	1.0KV	1.1KV	1.3KV	1.5KV	2.0KV	2.0KV
	N-PE (1.2/50)	0.8KV	0.8KV	1.2KV	1.2KV	1.2KV	1.2KV	1.4KV	1.6KV	1.6KV
Response time	L-N	≤25 ns								
	N-PE	≤100 ns								
Follow current	L-N	No								
	N-PE	If ≥ 100Arms @ Uc								
Backup fuse(only required if not already provided in mains)		315A gL/gG								
Operating temperature range		- 40°C ~ + 80°C								
Cross-section of connection wire		Single-strand 35mm ² ; multi-strand 25mm ²								
Mounting		35mm DIN-rail in accordance with EN 50022/DIN46277-3								
Enclosure material		Thermoplastic ; extinguishing degree UL94 V-0								
Degree of protection		IP20								
Installation width		4 modules , DIN 43880								
Thermal disconnecter		Internal green – normal red - failure								
Remote alarm contact		Optional								

Dimensions and Diagram

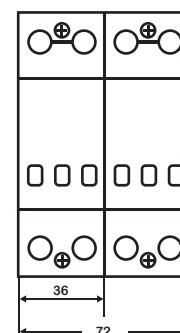
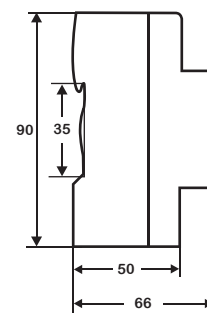
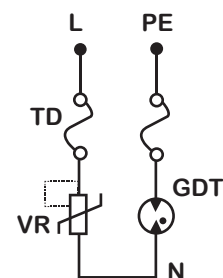

Note: Subject to change without any notice.

Single Phase (1 MOV& 1GDT Modules) Surge Protection Devices Type D1-150/***-VG-R

Surge arrester for low-voltage power supply system protection against surges at the boundaries from lightning protection zone 0B-1 and higher.

- Class I+II (B+C) arrester in according with IEC61643-1:2005.
- Two part design consisting of base and non-pluggable protection module.
- High energy MOV (Metal Oxide Varistor) and GDT (Gas Discharge Tube) inside.
- Reliable supervision due to disconnection device.
- Fault indication by red indication flag in window.
- Fast response.
- With remote alarm terminal optional.



Characteristics

Type	D1-150/***-VG-R							
		150	175	275	300	320	385	
In accordance with	IEC61643-1:2005 ; UL1449 3rd							
Category IEC/VDE	I+II / B+C							
Max. continuous operating voltage (AC/DC)	L - N (AC/DC)	150/200	175/225	275/300	300/385	320/420	385/505	
	N-PE Uc	150	150	255	255	255	255	
Nominal discharge current(8/20) In	L-N	70KA						
	N-PE	70KA						
Max. discharge current(8/20) Imax	L-N	150KA						
	N - PE	150KA						
Lightning impulse current(10/350) Iimp	L-N	25KA						
	N - PE	50KA						
Voltage protection level	L-N@In	0.8KV	0.8KV	1.3KV	1.4KV	1.5KV	1.8KV	
	L-N@3KA	0.5KV	0.6KV	0.9KV	1.0KV	1.1KV	1.3KV	
	N-PE (1.2/50)	0.8KV	0.8KV	1.2KV	1.2KV	1.2KV	1.2KV	
Response time	L-N	≤25 ns						
	N-PE	≤100 ns						
Follow current	L-N	No						
	N-PE	If ≥ 100Arms @ Uc						
Backup fuse (only required if not already provided in mains)		315A gL/gG						
Operating temperature range		- 40°C ~ + 80°C						
Cross-section of connection wire		Single-strand 35mm ² ; multi-strand 25mm ²						
Mounting		35mm DIN-rail in accordance with EN 50022 / DIN46277-3						
Enclosure material		Thermoplastic ; extinguishing degree UL94 V-0						
Degree of protection		IP20						
Installation width		4 modules , DIN 43880						
Remote alarm contact		Optional						

Dimensions and Diagram

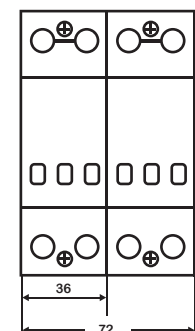
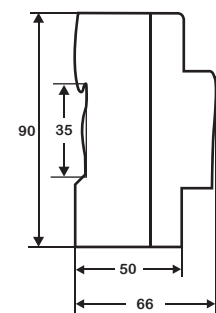
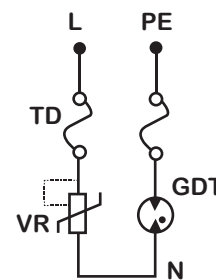

Note: Subject to change without any notice.

Three Phase (3 MOV& 1GDT Modules) Surge Protective Devices Type D3-25/***-3VG-R

Surge arrester for low-voltage power supply system protection against surges at the boundaries from lightning protection zone 0B-1 and higher.

- Class II (C) arrester in according with IEC61643-1:2005.
- Two part design consisting of base and protection module including plug-in module and non-pluggable module.
- High energy MOV (Metal Oxide Varistor) and GDT (Gas Discharge Tube) inside.
- Reliable supervision due to disconnection device.
- Fault indication by red indication flag in window.
- Fast response.
- With remote alarm terminal optional.

Rapid thermal disconnection under TOV ;
Inbuilt Arc - extinguishing device.

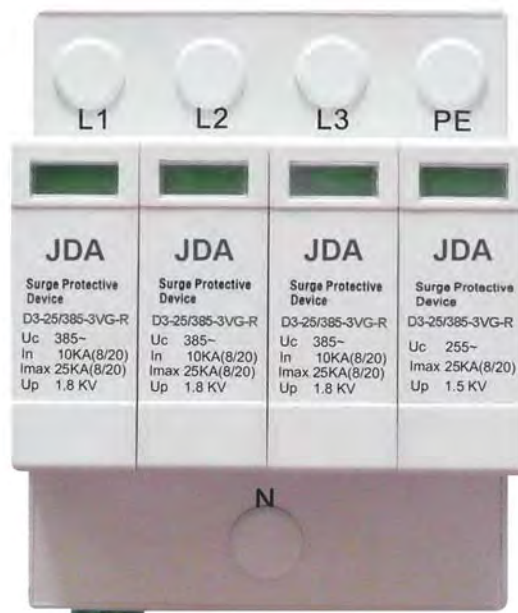

Characteristics

Type	D3-25/***-3VG-R										
	75	150	175	275	300	320	385	440	550	600	
In accordance with	IEC61643-1:2005 ; UL1449 3rd										
Category IEC/VDE	II / C										
Max. continuous operating voltage (AC/DC)	L - N (AC/DC)	75/100	150/200	175/225	275/300	300/385	320/420	385/505	440/585	550/745	600/800
	N - PE U _c	65	150	150	255	255	255	255	350	440	440
Nominal discharge current(8/20) I _n	L-N	10KA									
	N-PE	10KA									
Max. discharge current(8/20) I _{max}	L-N	25KA									
	N - PE	25KA									
Voltage protection level	L-N@I _n	0.4KV	0.8KV	0.8KV	1.3KV	1.3KV	1.5KV	1.8KV	2.0KV	2.5KV	2.6KV
	L-N@3KA	0.25KV	0.5KV	0.6KV	0.9KV	1.0KV	1.1KV	1.3KV	1.5KV	2.0KV	2.1KV
	N-PE (1.2/50)	0.5KV	0.8KV	0.8KV	1.0KV	1.0KV	1.0KV	1.0KV	1.2KV	1.3KV	1.3KV
Response time	L-N	≤25 ns									
	N-PE	≤100 ns									
Follow current	L-N	No									
	N-PE	100Arms @U _c									
Backup fuse	100A gL/gG										
(only required if not already provided in mains)											
Operating temperature range	- 40°C~ + 80°C										
Cross-section of connection wire	Single-strand 35mm ² ; multi-strand 25mm ²										
Mounting	35mm DIN-rail in accordance with EN 50022 / DIN46277-3										
Enclosure material	Thermoplastic ; extinguishing degree UL94 V-0										
Degree of protection	IP20										
Installation width	4 modules , DIN 43880										
Thermal disconnecter	Internal green - normal red - failure										
Remote alarm contact	Optional										

Dimensions and Diagram

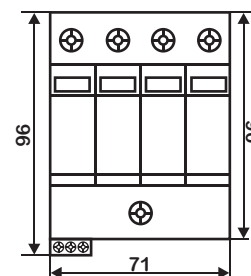
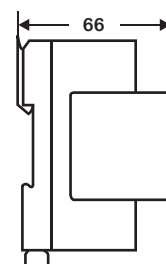
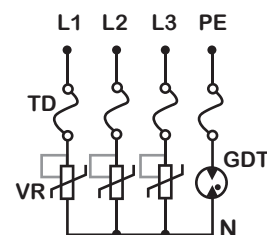

Note: Subject to change without any notice.

Three Phase (3 MOV& 1GDT Modules) Surge Protective Devices Type D3-40/***-3VG-R

Surge arrester for low-voltage power supply system protection against surges at the boundaries from lightning protection zone 0B-1 and higher.

- Class II (C) arrester in according with IEC61643-1:2005.
- Fail Safe System (Patent)
- Two part design consisting of base and plug-in protection module.
- High energy MOV (Metal Oxide Varistor) and GDT (Gas Discharge Tube) inside.
- Reliable supervision due to disconnection device.
- Fault indication by red indication flag in window.
- Fast response.
- With remote alarm terminal optional.

Rapid thermal disconnection under TOV ;
Inbuilt Arc - extinguishing device.

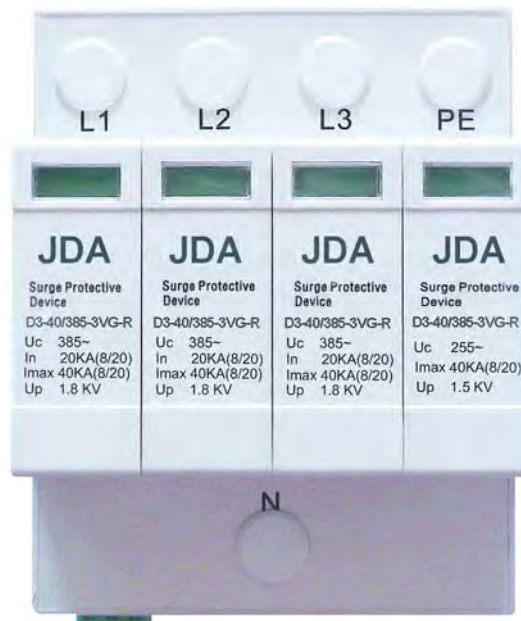

Characteristics

Type	D3-40/***-3VG-R										
	75	150	175	275	300	320	385	440	550	600	
In accordance with	IEC61643-1:2005 ; UL1449 3rd										
Category IEC/VDE	II / C										
Max. continuous operating voltage (AC/DC)	L-N (AC/DC)	75/100	150/200	175/225	275/300	300/385	320/420	385/505	440/585	550/745	600/800
	N - PE Uc	65	150	150	255	255	255	255	350	440	440
Nominal discharge current (8/20) In	L-N	20KA									
	N-PE	20KA									
Max. discharge current (8/20) Imax	L-N	40KA									
	N - PE	40KA									
Voltage	L-N@In	0.5KV	0.8KV	0.8KV	1.4KV	1.5KV	1.6KV	1.8KV	2.2KV	2.8KV	3.0KV
	L-N@3KA	0.3KV	0.5KV	0.6KV	1.0KV	1.0KV	1.1KV	1.3KV	1.5KV	2.0KV	2.0KV
protection level	N-PE (1.2/50)	≤1.5KV									
Response time	L-N	≤25 ns									
	N-PE	≤100 ns									
Follow current	L-N	No									
	N-PE	100Arms@Uc									
Backup fuse		125A gL/gG									
<small>(only required if not already provided in mains)</small>											
Operating temperature range		- 40°C ~ + 80°C									
Cross-section of connection wire		Single-strand 35mm ² ; multi-strand 25mm ²									
Mounting		35mm DIN-rail in accordance with EN 50022/DIN46277-3									
Enclosure material		Thermoplastic ; extinguishing degree UL94 V-0									
Degree of protection		IP20									
Installation width		4 modules , DIN 43880									
Thermal disconnecter		Internal green – normal red - failure									
Remote alarm contact		Optional									

Dimensions and Diagram

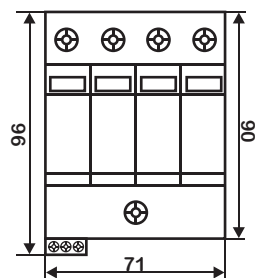
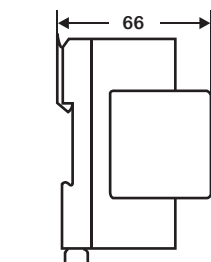
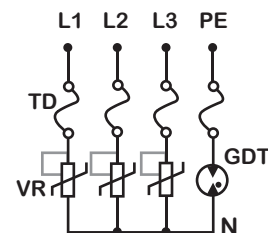

Note: Subject to change without any notice.

Three Phase (3 MOV& 1GDT Modules) Surge Protection Devices Type D3-50/***-3VG-R

Surge arrester for low-voltage power supply system protection against surges at the boundaries from lightning protection zone 0B-1 and higher.

- Class II (C) arrester in according with IEC61643-1:2005.
- Fail Safe System (Patent)
- Two part design consisting of base and plug-in protection module.
- High energy MOV (Metal Oxide Varistor) and GDT (Gas Discharge Tube) inside.
- Reliable supervision due to disconnection device.
- Fault indication by red indication flag in window.
- Fast response.
- With remote alarm terminal optional.

Rapid thermal disconnection under TOV ;
Inbuilt Arc - extinguishing device.



Characteristics

Type		D3-50/***-3VG-R									
		75	150	175	275	300	320	385	440	550	600
In accordance with		IEC61643-1:2005 ; UL1449 3rd									
Category IEC/VDE		II / C									
Max. continuous operating voltage (AC/DC)	L - N	75/	150/	175/	275/	300/	320/	385/	440/	550/	600/
	(AC/DC)	100	200	225	300	385	420	505	585	745	800
Nominal discharge current(8/20) In	N - PE Uc	65	150	150	255	255	255	255	350	440	440
	L-N	20KA									
Max. discharge current(8/20) Imax	N-PE	20KA									
	L-N	50KA									
Voltage protection level	L-N@In	0.5KV	0.8KV	0.8KV	1.4KV	1.5KV	1.6KV	1.8KV	2.2KV	2.8KV	3.0KV
	L-N@3KA	0.3KV	0.5KV	0.6KV	1.0KV	1.0KV	1.1KV	1.3KV	1.5KV	2.0KV	2.0KV
	N-PE(1.2/50)	≤1.5KV									
Response time	L-N	≤25 ns									
	L-PE	≤100 ns									
Follow current	L-N	No									
	L-PE	100Arms@Uc									
Backup fuse	125A gL/gG										
(only required if not already provided in mains)											
Operating temperature range	- 40°C ~ + 80°C										
Cross-section of connection wire	Single-strand 35mm ² ; multi-strand 25mm ²										
Mounting	35mm DIN-rail in accordance with EN 50022/DIN46277-3										
Enclosure material	Thermoplastic ; extinguishing degree UL94 V-0										
Degree of protection	IP20										
Installation width	4 modules , DIN 43880										
Thermal disconnecter	Internal green – normal red - failure										
Remote alarm contact	Optional										

Dimensions and Diagram

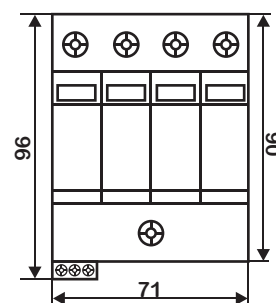
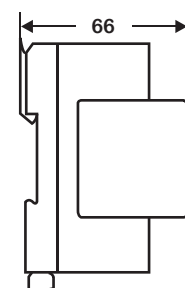
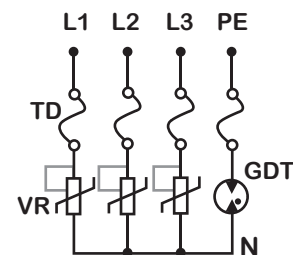

Note: Subject to change without any notice.

Three Phase (3MOV & 1GDT Module) Surge Protection Devices Type D3-60/***-3VG-R

Surge arrester for low-voltage power supply system protection against surges at the boundaries from lightning protection zone 0B-1 and higher.

- Class I+II (B+C) arrester in according with IEC61643-1:2005.
- Two part design consisting of base and plug-in protection module.
- High energy MOV (Metal Oxide Varistor) and GDT (Gas Discharge Tube) inside.
- Reliable supervision due to disconnection device.
- Fault indication by red indication flag in window.
- Fast response.
- With remote alarm terminal optional.

Rapid thermal disconnection under TOV ;
Inbuilt Arc - extinguishing device.

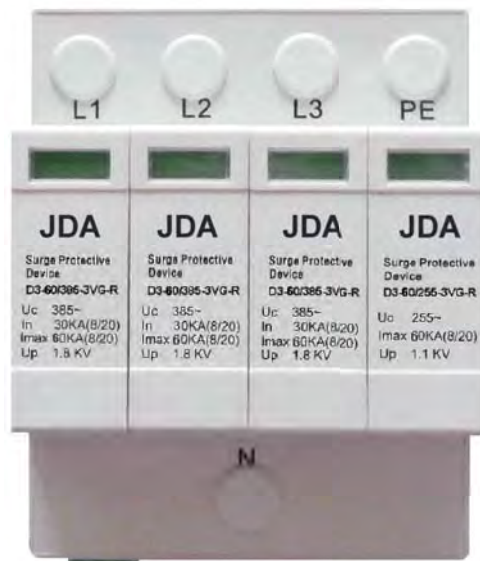

Characteristics

Type	D3-60/***-3VG-R											
		75	150	175	275	300	320	385	440	550	600	
In accordance with		IEC61643-1:2005 ; UL1449 3rd										
Category IEC/VDE		I+II / B+C										
Max. continuous operating voltage (AC/DC)	L-N	75	150	175	275	300	320	385	440	550	600	
(AC/DC)	N-PE Uc	/100	/200	/225	/300	/385	/420	/505	/585	/745	/800	
Nominal discharge current (8/20) In	L-N	30KA										
Max. discharge current (8/20) I _{max}	N-PE	60KA										
Lightning impulse current (10/350) I _{imp}	L-N	7KA										
	N-PE	15KA										
Voltage protection level	L-N@In	0.5KV	0.8KV	0.8KV	1.3KV	1.4KV	1.5KV	1.8KV	2.2KV	2.8KV	3.0KV	
	L-N@3KA	0.3KV	0.5KV	0.6KV	1.0KV	1.0KV	1.1KV	1.3KV	1.5KV	2.0KV	2.1KV	
	N-PE (1.2/50)	0.5KV	0.8KV	0.8KV	1.0KV	1.0KV	1.0KV	1.0KV	1.2KV	1.6KV	1.6KV	
Response time	L-N	≤25 ns										
	N-PE	≤100 ns										
Follow current	L-N	No										
	N-PE	≥100Arms @ Uc										
Backup fuse (only required if not already provided in mains)		160A gL/gG										
Operating temperature range		- 40°C ~ + 80°C										
Cross-section of connection wire		Single-strand 35mm ² ; multi-strand 25mm ²										
Mounting		35mm DIN-rail in accordance with EN 50022 / DIN46277-3										
Enclosure material		Thermoplastic ; extinguishing degree UL94 V-0										
Degree of protection		IP20										
Installation width		4 modules , DIN 43880										
Thermal disconnecter		Internal green – normal red - failure										
Remote alarm contact		Optional										

Dimensions and Diagram

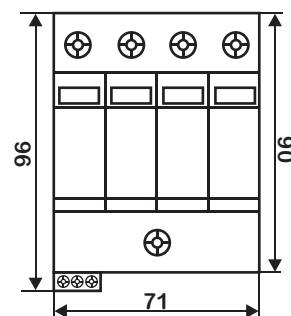
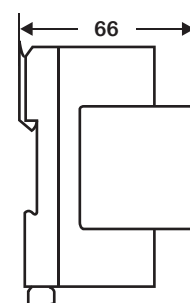
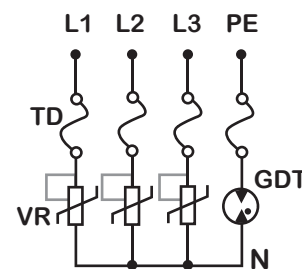

Note: Subject to change without any notice.

Three Phase (3 MOV& 1GDT Modules) Surge Protective Devices Type D3-80/***-3VG-R

Surge arrester for low-voltage power supply system protection against surges at the boundaries from lightning protection zone 0B-1 and higher.

- Class I+II (B+C) arrester in according with IEC61643-1:2005.
- Two part design consisting of base and non-pluggable protection module.
- High energy MOV (Metal Oxide Varistor) and GDT (Gas Discharge Tube) inside.
- Reliable supervision due to disconnection device.
- Fault indication by red indication flag in window.
- Fast response.
- With remote alarm terminal optional.



Characteristics

Type	D3-80/***-3VG-R									
	150	175	275	300	320	385	440	550	600	
In accordance with IEC61643-1:2005 ; UL1449 3rd										
Category IEC/VDE I+II / B+C										
Max. continuous operating voltage (AC/DC)	L – N (AC/DC)	150/200	175/225	275/300	300/385	320/420	385/505	440/585	550/745	600/800
	N – PE Uc	150	150	255	255	255	255	350	440	440
Nominal discharge current (8/20) In	L-N	40KA								
	N-PE	40KA								
Max. discharge current (8/20) Imax	L-N	80KA								
	N - PE	80KA								
Lightning impulse current (10/350) Iimp	L-N	10KA								
	N - PE	25KA								
Voltage protection level	L-N@In	0.8KV	0.8KV	1.3KV	1.4KV	1.6KV	1.8KV	2.1KV	2.8KV	3.0KV
	L-N@3KA	0.5KV	0.6KV	1.0KV	1.0KV	1.1KV	1.3KV	1.5KV	2.0KV	2.1KV
	N-PE (1.2/50)	0.8KV	0.8KV	1.0KV	1.0KV	1.0KV	1.0KV	1.2KV	1.6KV	1.6KV
Response time	L-N	≤25 ns								
	N-PE	≤100 ns								
Follow current	L-N	No								
	N-PE	100Arms @ Uc								
Backup fuse	200A gL/GG									
(only required if not already provided in mains)										
Operating temperature range	- 40°C ~ + 80°C									
Cross-section of connection wire	Single-strand 35mm ² ; multi-strand 25mm ²									
Mounting	35mm DIN-rail in accordance with EN 50022 / DIN46277-3									
Enclosure material	Thermoplastic ; extinguishing degree UL94 V-0									
Degree of protection	IP20									
Installation width	8 modules , DIN 43880									
Thermal disconnecter	Internal green – normal red - failure									
Remote alarm contact	Optional									

Dimensions and Diagram

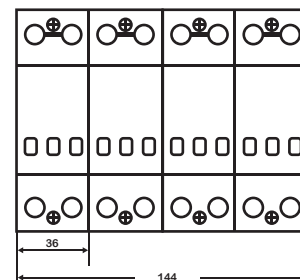
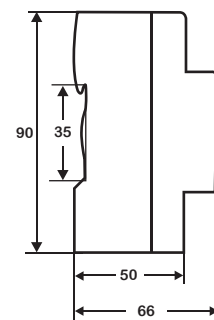
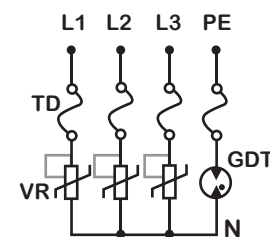

Note: Subject to change without any notice.

Three Phase (3 MOV& 1GDT Modules) Surge Protective Devices Type D3-100/***-3VG-R

Surge arrester for low-voltage power supply system protection against surges at the boundaries from lightning protection zone 0B-1 and higher.

- Class I+II (B+C) arrester in according with IEC61643-1:2005.
- Two part design consisting of base and non-pluggable protection module.
- High energy MOV (Metal Oxide Varistor) and GDT (Gas Discharge Tube) inside.
- Reliable supervision due to disconnection device.
- Fault indication by red indication flag in window.
- Fast response.
- With remote alarm terminal optional.



Characteristics

Type		D3-100/***-3VG-R								
		150	175	275	300	320	385	440	550	600
In accordance with		IEC61643-1:2005 ; UL1449 3rd								
Category IEC/VDE		I+II / B+C								
Max. continuous operating voltage (AC/DC)	L – N (AC/DC)	150/200	175/225	275/300	300/385	320/420	385/505	440/585	550/745	600/800
	N – PE U _c	150	150	255	255	255	255	350	440	440
Nominal discharge current (8/20) I _n	L-N	50KA								
	N-PE	50KA								
Max. discharge current (8/20) I _{max}	L-N	100KA								
	N - PE	100KA								
Lightning impulse current (10/350) I _{imp}	L-N	12.5KA								
	N - PE	25KA								
Voltage protection level	L-N@I _n	0.5KV	0.8KV	0.8KV	1.3KV	1.5KV	1.5KV	1.8KV	2.2KV	2.8KV
	L-N@3KA	0.3KV	0.5KV	0.6KV	1.0KV	1.0KV	1.1KV	1.3KV	1.5KV	2.0KV
	N-PE (1.2/50)	0.8KV	0.8KV	1.2KV	1.2KV	1.5KV	1.5KV	1.4KV	1.6KV	1.6KV
Response time	L-N	≤25 ns								
	N-PE	≤100 ns								
Follow current	L-N	No								
	N-PE	100Arms @ U _c								
Backup fuse	250A gL/gG									
(only required if not already provided in mains)										
Operating temperature range	- 40°C ~ + 80°C									
Cross-section of connection wire	Single-strand 35mm ² ; multi-strand 25mm ²									
Mounting	35mm DIN-rail in accordance with EN 50022 / DIN46277-3									
Enclosure material	Thermoplastic ; extinguishing degree UL94 V-0									
Degree of protection	IP20									
Installation width	8 modules , DIN 43880									
Thermal disconnecter	Internal green – normal red - failure									
Remote alarm contact	Optional									

Dimensions and Diagram

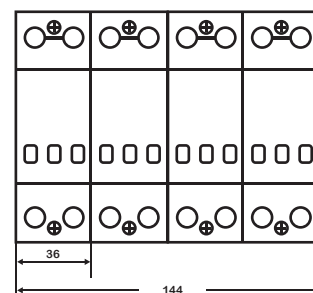
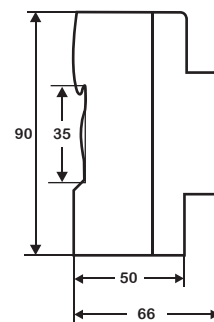
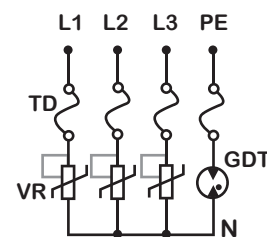

Note: Subject to change without any notice.

Three Phase (3 MOV& 1GDT Modules) Surge Protective Devices Type D3-120/***-3VG-R

Surge arrester for low-voltage power supply system protection against surges at the boundaries from lightning protection zone 0B-1 and higher.

- Class I+II (B+C) arrester in according with IEC61643-1:2005.
- Two part design consisting of base and non-pluggable protection module.
- High energy MOV (Metal Oxide Varistor) and GDT (Gas Discharge Tube) inside.
- Reliable supervision due to disconnection device.
- Fault indication by red indication flag in window.
- Fast response.
- With remote alarm terminal optional.



Characteristics

Type		D3-120/***-3VG-R								
		150	175	275	300	320	385	440	550	600
In accordance with		IEC61643-1:2005 ; UL1449 3rd								
Category IEC/VDE		I+II / B+C								
Max. continuous operating voltage (AC/DC)	L - N(AC/DC)	150/200	175/225	275/300	300/385	320/420	385/505	440/585	550/745	600/800
	N - PE Uc	150	150	255	255	255	255	350	440	440
Nominal discharge current(8/20) In	L-N	60KA								
	N-PE	60KA								
Max. discharge current(8/20) Imax	L-N	120KA								
	N - PE	120KA								
Lightning impulse current(10/350) Iimp	L-N	12.5KA								
	N - PE	25KA								
Voltage protection level	L-N@In	0.8KV	0.8KV	1.3KV	1.4KV	1.5KV	1.8KV	2.1KV	2.8KV	3.0KV
	L-N@3KA	0.5KV	0.6KV	0.9KV	1.0KV	1.1KV	1.3KV	1.5KV	2.0KV	2.0KV
	N-PE (1.2/50)	0.8KV	0.8KV	1.2KV	1.2KV	1.2KV	1.2KV	1.4KV	1.6KV	1.6KV
Response time	L-N	≤25 ns								
	N-PE	≤100 ns								
Follow current	L-N	No								
	N-PE	100Arms @ Uc								
Backup fuse		315A gL/gG								
(only required if not already provided in mains)										
Operating temperature range		- 40°C ~ + 80°C								
Cross-section of connection wire		Single-strand 35mm ² ; multi-strand 25mm ²								
Mounting		35mm DIN-rail in accordance with EN 50022 / DIN46277-3								
Enclosure material		Thermoplastic ; extinguishing degree UL94 V-0								
Degree of protection		IP20								
Installation width		8 modules , DIN 43880								
Thermal disconnecter		Internal green - normal red - failure								
Remote alarm contact		Optional								

Dimensions and Diagram

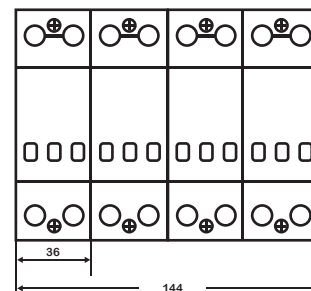
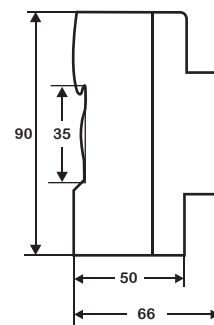
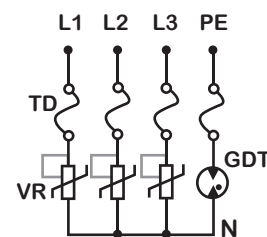

Note: Subject to change without any notice.

Three Phase (3 MOV& 1GDT Modules) Surge Protective Devices Type D3-150/***-3VG-R

Surge arrester for low-voltage power supply system protection against surges at the boundaries from lightning protection zone 0B-1 and higher.

- Class I+II (B+C) arrester in according with IEC61643-1:2005.
- Two part design consisting of base and non-pluggable protection module.
- High energy MOV (Metal Oxide Varistor) and GDT (Gas Discharge Tube) inside.
- Reliable supervision due to disconnection device.
- Fault indication by red indication flag in window.
- Fast response.
- With remote alarm terminal optional.



Characteristics

Type	D3-150/***-3VG-R						
	150	175	275	300	320	385	
In accordance with	IEC61643-1:2005 ; UL1449 3rd						
Category IEC/VDE	I+II / B+C						
Max. continuous operating voltage (AC/DC)	L – N (AC/DC)	150/200	175/225	275/300	300/385	320/420	385/505
	N – PE Uc	150	150	255	255	255	255
Nominal discharge current (8/20) In	L-N	70KA					
	N-PE	70KA					
Max. discharge current (8/20) Imax	L-N	150KA					
	N - PE	150KA					
Lightning impulse current (10/350) Iimp	L-N	25KA					
	N - PE	35KA					
Voltage protection level	L-N@In	0.8KV	0.8KV	1.3KV	1.4KV	1.5KV	1.8KV
	L-N@3KA	0.5KV	0.6KV	0.9KV	1.0KV	1.1KV	1.3KV
	N-PE (1.2/50)	0.8KV	0.8KV	1.2KV	1.2KV	1.2KV	1.2KV
Response time	L-N	≤25 ns					
	N-PE	≤100 ns					
Follow current	L-N	No					
	N-PE	100Arms @ Uc					
Backup fuse (only required if not already provided in mains)	315A gL/gG						
Operating temperature range	- 40°C ~ + 80°C						
Cross-section of connection wire	Single-strand 35mm ² ; multi-strand 25mm ²						
Mounting	35mm DIN-rail in accordance with EN 50022 / DIN46277-3						
Enclosure material	Thermoplastic ; extinguishing degree UL94 V-0						
Degree of protection	IP20						
Installation width	8 modules , DIN 43880						
Remote alarm contact	Optional						

Dimensions and Diagram

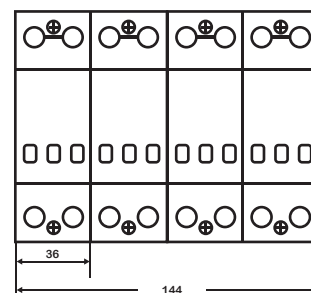
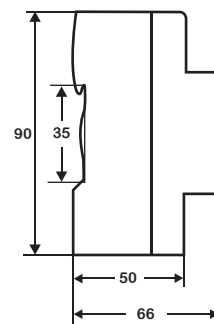
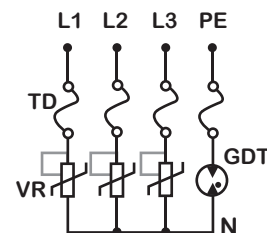

Note: Subject to change without any notice.

MOV&GDT in Series Module Surge Protection Devices Type MVGT25/***-R

Dimensions and Diagram

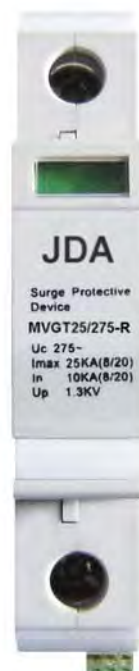
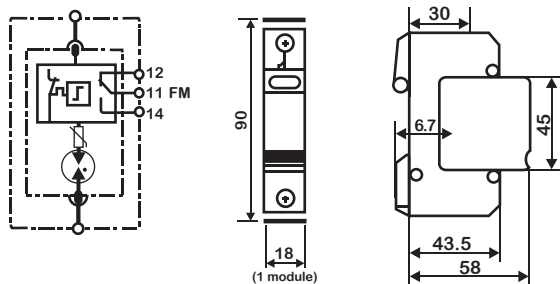

- Class II (C) arrester in according with IEC61643-1:2005.
- Two part design consisting of base and plug-in protection module
- High energy MOV (Metal Oxide Varistor) & GDT (Gas Discharge Tube) in series inside.
- Reliable supervision due to disconnection device
- Fault indication by red indication flag in window
- No leakage current and No follow current
- With remote alarm terminal optional

Rapid thermal disconnection under TOV ;
Inbuilt Arc - extinguishing device.

Characteristics

Type	MVGT 25/***-R									
	75	150	175	275	300	320	385	440	550	600
In accordance with	IEC61643-1:2005 ; UL1449 3rd									
Category IEC / VDE	II / C									
Max. continuous operating voltage (AC/DC)	75/100	150/200	175/225	275/300	300/385	320/420	385/505	440/585	550/745	600/800
Nominal discharge current (8/20) In	10KA									
Max. discharge current (8/20) Imax	25KA									
Voltage protection level at In	0.3KV	0.6KV	0.6KV	1.3KV	1.3KV	1.5KV	1.5KV	1.8KV	2.0KV	2.0KV
Let through voltage @3KA (8/20)	0.2KV	0.5KV	0.5KV	0.8KV	0.8KV	0.8KV	0.8KV	1.2KV	1.6KV	1.6KV
Response time (MOV/GDT)	≤25 ns / ≤100 ns									
Follow / leakage current	No / No									
Backup fuse <small>(only required if not already provided in mains)</small>	100A gL/gG									
Operating temperature range	- 40°C~ + 80°C									
Cross-section of connection wire	Single-strand 35mm ² ; multi-strand 25mm ²									
Mounting	35mm DIN-rail in accordance with EN 50022 / DIN46277-3									
Enclosure material	Thermoplastic ; extinguishing degree UL94 V-0									
Degree of protection	IP20									
Installation width	1 module , DIN 43880									
Thermal disconnecter	Internal green – normal red - failure									
Remote alarm contact	Optional									
Additional data for Remote Alarm Contacts										
Remote alarm contact type	floating changeover contact									
Switching capability U _N /I _N	AC: 250V/0.5A					DC: 250V/0.1A ; 125V/0.2A ; 75V/0.5A				
Cross-section of connection wire	Max. 1.5mm ²									

Note: Subject to change without any notice.

MOV&GDT in Series Module Surge Protective Devices Type MVGT40/***-R

Dimensions and Diagram

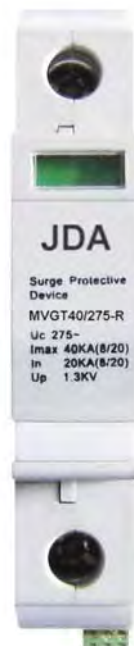
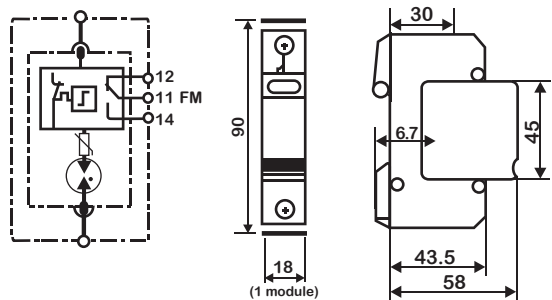

- Class II (C) arrester in according with IEC61643-1:2005.
- Fail Safe System (Patent)
- Two part design consisting of base and plug-in protection module.
- High energy MOV (Metal Oxide Varistor) & GDT (Gas Discharge Tube) in series inside.
- Reliable supervision due to disconnection device.
- Fault indication by red indication flag in window.
- Fast response.
- With remote alarm terminal optional.

Rapid thermal disconnection under TOV ;
Inbuilt Arc - extinguishing device.

Characteristics

Type	MVGT 40/***-R									
	75	150	175	275	300	320	385	440	550	600
In accordance with	IEC61643-1:2005 ; UL1449 3rd									
Category IEC/VDE	II / C									
Max. continuous operating voltage (AC/DC)	75/100	150/200	175/225	275/300	300/385	320/420	385/505	440/585	550/745	600/800
Nominal discharge current (8/20) In	20KA									
Max. discharge current(8/20) Imax	40KA									
Voltage protection level at In	0.5KV	0.8KV	0.8KV	1.3KV	1.5KV	1.5KV	1.6KV	2.2KV	2.8KV	3.0KV
Let through voltage @3KA (8/20)	0.3KV	0.5KV	0.6KV	1.0KV	1.0KV	1.0KV	1.3KV	1.5KV	2.0KV	2.0KV
Response time (MOV/GDT)	≤25ns / ≤100ns									
Follow / leakage current	No / No									
Backup fuse <small>(only required if not already provided in mains)</small>	125A gL/gG									
Operating temperature range	- 40°C ~ + 80°C									
Cross-section of connection wire	Single-strand 35mm ² ; multi-strand 25mm ²									
Mounting	35mm DIN-rail in accordance with EN 50022 / DIN46277-3									
Enclosure material	Thermoplastic ; extinguishing degree UL94 V-0									
Degree of protection	IP20									
Installation width	1 module , DIN 43880									
Thermal disconnecter	Internal green – normal red - failure									
Remote alarm contact	Optional									
Additional data for Remote Alarm Contacts										
Remote alarm contact type	floating changeover contact									
Switching capability U _N /I _N	AC: 250V/0.5A					DC: 250V/0.1A ; 125V/0.2A ; 75V/0.5A				
Cross-section of connection wire	Max. 1.5mm ²									

Note: Subject to change without any notice.

MOV&GDT in Series Module Surge Protective Devices Type MVGT60/***-R

Dimensions and Diagram

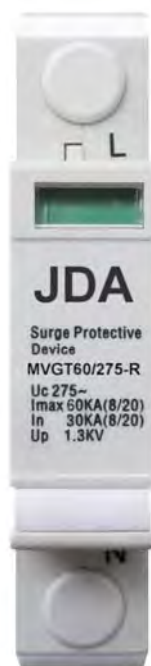
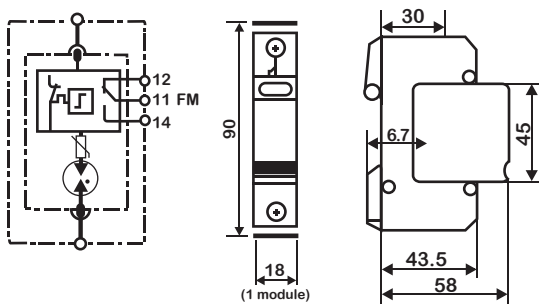

- Class I+II (B+C) arrester in according with IEC61643-1:2005.
- Two part design consisting of base and plug-in protection module
- High energy MOV (Metal Oxide Varistor) & GDT (Gas Discharge Tube) in series inside.
- Reliable supervision due to disconnection device
- Fault indication by red indication flag in window
- No leakage current and No follow current
- With remote alarm terminal optional

Rapid thermal disconnection under TOV ;
Inbuilt Arc - extinguishing device.

Characteristics

Type	MVGT 60/***-R									
	75	150	175	275	300	320	385	440	550	600
In accordance with	IEC61643-1:2005 ; UL1449 3rd									
Category IEC/VDE	I+II / B+C									
Max. continuous operating voltage (AC/DC)	75/100	150/200	175/225	275/300	300/385	320/420	385/505	440/585	550/745	600/800
Nominal discharge current (8/20) In	30KA									
Max. discharge current (8/20) Imax	60KA									
Lightning impulse current (10/350) Iimp	7KA									
Voltage protection level at In	0.3KV	0.6KV	0.6KV	1.2KV	1.2KV	1.2KV	1.2KV	1.8KV	2.4KV	2.4KV
Let through voltage @3KA 8/20	0.2KV	0.5KV	0.5KV	0.8KV	0.8KV	0.8KV	0.8KV	1.2KV	1.6KV	1.6KV
Response time (MOV/GDT)	≤25 ns / ≤100 ns									
Follow / leakage current	No / No									
Backup fuse <small>(only required if not already provided in mains)</small>	160A gL/gG									
Operating temperature range	- 40°C ~ + 80°C									
Cross-section of connection wire	Single-strand 35mm ² ; multi-strand 25mm ²									
Mounting	35mm DIN-rail in accordance with EN 50022 / DIN46277-3									
Enclosure material	Thermoplastic ; extinguishing degree UL94 V-0									
Degree of protection	IP20									
Installation width	1 module , DIN 43880									
Thermal disconnecter	Internal green – normal red - failure									
Remote alarm contact	Optional									
Additional data for Remote Alarm Contacts										
Remote alarm contact type	floating changeover contact									
Switching capability UN/IN	AC: 250V/0.5A					DC: 250V/0.1A ; 125V/0.2A ; 75V/0.5A				
Cross-section of connection wire	Max. 1.5mm ²									

Note: Subject to change without any notice.

MOV&GDT in Series Module Surge Protection Devices Type MVGT80/***-R

- Class I+II (B+C) arrester in according with IEC61643-1:2005.
- Two part design consisting of base and non-pluggable protection module.
- High energy MOV (Metal Oxide Varistor) & GDT (Gas Discharge Tube) in series inside.
- Reliable supervision due to disconnection device
- Fault indication by red indication flag in window
- No leakage current and No follow current
- With remote alarm terminal optional



Dimensions and Diagram

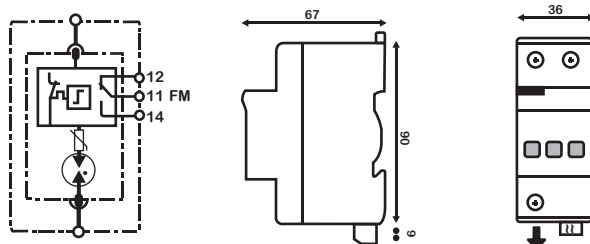

Characteristics

Type	MVGT 80/***-R									
	150	175	275	300	320	385	440	550	600	
In accordance with	IEC61643-1:2005 ; UL1449 3rd									
Category IEC/VDE	I+II / B+C									
Max. continuous operating voltage (AC/DC)	150/200	175/225	275/300	300/385	320/420	385/505	440/585	550/745	600/800	
Nominal discharge current (8/20) In	40KA									
Max. discharge current (8/20) Imax	80KA									
Lightning impulse current (10/350) Iimp	10KA									
Voltage protection level at In	0.6KV	0.6KV	1.2KV	1.2KV	1.2KV	1.2KV	1.8KV	2.4KV	2.4KV	
Let through voltage @3KA 8/20	0.5KV	0.5KV	0.8KV	0.8KV	0.8KV	0.8KV	1.2KV	1.6KV	1.6KV	
Response time (MOV/GDT)	≤25 ns / ≤100 ns									
Follow / leakage current	No / No									
Backup fuse <small>(only required if not already provided in mains)</small>	200A gL/gG									
Operating temperature range	- 40°C ~ + 80°C									
Cross-section of connection wire	Single-strand 35mm ² ; multi-strand 25mm ²									
Mounting	35mm DIN-rail in accordance with EN 50022 / DIN46277-3									
Enclosure material	Thermoplastic ; extinguishing degree UL94 V-0									
Degree of protection	IP20									
Installation width	2 modules , DIN 43880									
Thermal disconnecter	Internal green – normal red - failure									
Remote alarm contact	Optional									
Additional data for Remote Alarm Contacts										
Remote alarm contact type	floating changeover contact									
Switching capability U _N /I _N	AC: 250V/0.5A					DC: 250V/0.1A ; 125V/0.2A ; 75V/0.5A				
Cross-section of connection wire	Max. 1.5mm ²									

Note: Subject to change without any notice.

MOV&GDT in Series Module Surge Protection Devices

Type MVGT100/***-R

- Class I+II (B+C) arrester in according with IEC61643-1:2005.
- Two part design consisting of base and non-pluggable protection module.
- High energy MOV (Metal Oxide Varistor) & GDT (Gas Discharge Tube) in series inside.
- Reliable supervision due to disconnection device
- Fault indication by red indication flag in window
- No leakage current and No follow current
- With remote alarm terminal optional.



Dimensions and Diagram

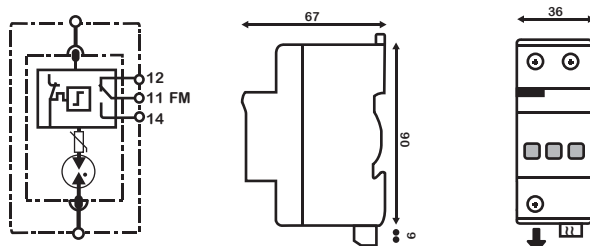

Characteristics

Type	MVGT 100/***-R									
	150	175	275	300	320	385	440	550	600	
In accordance with	IEC61643-1:2005 ; UL1449 3rd									
Category IEC/VDE	I+II / B+C									
Max. continuous operating voltage (AC/DC)	150/200	175/225	275/300	300/385	320/420	385/505	440/585	550/745	600/800	
Nominal discharge current (8/20) In	50KA									
Max. discharge current (8/20) Imax	100KA									
Lightning impulse current (10/350) Iimp	12.5KA									
Voltage protection level at In	0.6KV	0.6KV	1.2KV	1.2KV	1.2KV	1.2KV	1.8KV	2.4KV	2.4KV	
Let through voltage @3KA 8/20	0.5KV	0.5KV	0.8KV	0.8KV	0.8KV	0.8KV	1.2KV	1.6KV	1.6KV	
Response time (MOV/GDT)	≤25 ns / ≤100 ns									
Follow / leakage current	No / No									
Backup fuse <small>(only required if not already provided in mains)</small>	250A gL/gG									
Operating temperature range	- 40°C~ + 80°C									
Cross-section of connection wire	Single-strand 35mm ² ; multi-strand 25mm ²									
Mounting	35mm DIN-rail in accordance with EN 50022 / DIN46277-3									
Enclosure material	Thermoplastic ; extinguishing degree UL94 V-0									
Degree of protection	IP20									
Installation width	2 modules , DIN 43880									
Thermal disconnecter	Internal green – normal red - failure									
Remote alarm contact	Optional									
Additional data for Remote Alarm Contacts										
Remote alarm contact type	floating changeover contact									
Switching capability UN/IN	AC: 250V/0.5A					DC: 250V/0.1A ; 125V/0.2A ; 75V/0.5A				
Cross-section of connection wire	Max. 1.5mm ²									

Note: Subject to change without any notice.

Class I+II Surge Protective Device for LV Power System Type MVGT150/***-R

- IEC61643-1; UL1449 3rd
- Uc 75~690Vac
 - High TOV capacity
 - Iimp 25KA (10/350)
 - MOV and GDT hybrid type, No leakage current and no follow current
 - Low voltage protection level (Up)
 - Fault indication
 - With remote signaling contact optional



Dimensions and Diagram

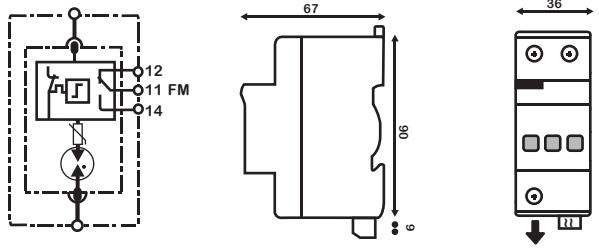

Characteristics

MVGT 150/***-R									
In accordance with	IEC61643-1:2005 ; UL1449 3rd								
Category IEC	I + II								
Max. continuous operating voltage (AC/DC)	150/200	175/225	275/350	320/420	385/505	420/560	510/570	550/745	690/910
Nominal discharge current (8/20) In	25KA								
Lightning impulse current(10/350) Iimp	25KA								
Voltage protection level at In	0.6KV	0.8KV	1.2KV	1.5KV	1.6KV	1.8KV	2.0KV	2.5KV	3.0KV
Response time (MOV/GDT)	≤25 ns / ≤100 ns								
Follow / leakage current	No / No								
Backup fuse (only required if not already provided in mains)	315A gL/gG								
Operating temperature range	- 40°C ~ + 80°C								
Cross-section of connection wire	Single-strand 35mm ² ; multi-strand 25mm ²								
Mounting	35 _{mm} DIN-rail in accordance with EN 50022/DIN46277-3								
Enclosure material	Thermoplastic ; extinguishing degree UL94 V-0								
Degree of protection	IP20								
Installation width	2 module , DIN 43880								
Thermal disconnecter	Internal green – normal red - failure								
Remote alarm contact	Optional								

Note: Subject to change without any notice.

Single Phase (2 MOV Modules) Surge Protection Devices Type D1-25/***-2MV-R

Surge arrester for low-voltage power supply system protection against surges at the boundaries from lightning protection zone 0B-1 and higher.

- Class II (C) arrester in according with IEC61643-1:2005
- Two part design consisting of base and plug-in protection module.
- High energy MOV (Metal Oxide Varistor) inside.
- Reliable supervision due to disconnection device.
- Fault indication by red indication flag in window.
- Fast response.
- With remote alarm terminal optional.

Rapid thermal disconnection under TOV ;
Inbuilt Arc - extinguishing device.



Characteristics

Type	D1-25/***-2MV-R										
	75	150	175	275	300	320	385	440	550	600	
In accordance with	IEC61643-1:2005 ; UL1449 3rd										
Category IEC/VDE	II / C										
Max. continuous operating voltage (AC/DC)	75/100	150/200	175/225	275/300	300/385	320/420	385/505	440/585	550/745	600/800	
Nominal discharge current(8/20) In	L-N	10KA									
	N-PE	10KA									
Max. discharge current(8/20) I _{max}	L-N	25KA									
	N - PE	25KA									
Voltage protection level	@In	0.4KV	0.8KV	0.8KV	1.3KV	1.3KV	1.5KV	1.8KV	2.0KV	2.5KV	2.6KV
	@3KA	0.25KV	0.5KV	0.6KV	0.9KV	1.0KV	1.1KV	1.3KV	1.5KV	2.0KV	2.1KV
Response time	L-N	≤25 ns									
	N-PE	≤25 ns									
Follow current	L-N	No									
	N-PE	No									
Backup fuse <small>(only required if not already provided in mains)</small>	100A gL/gG										
Operating temperature range	- 40°C ~ + 80°C										
Cross-section of connection wire	Single-strand 35mm ² ; multi-strand 25mm ²										
Mounting	35mm DIN-rail in accordance with EN 50022 / DIN46277-3										
Enclosure material	Thermoplastic ; extinguishing degree UL94 V-0										
Degree of protection	IP20										
Installation width	2 modules , DIN 43880										
Thermal disconnecter	Internal green – normal red - failure										
Remote alarm contact	Optional										

Dimensions and Diagram

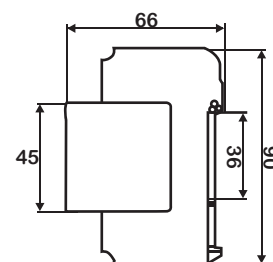
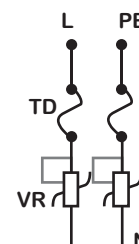

All dimension in mm

Note: Subject to change without any notice.

Single Phase (2 MOV Modules) Surge Protective Devices Type D1-40/***-2MV-R

Surge arrester for low-voltage power supply system protection against surges at the boundaries from lightning protection zone 0B-1 and higher.

- Class II (C) arrester in according with IEC61643-1:2005.
- Fail Safe System (Patent)
- Two part design consisting of base and plug-in protection module.
- High energy MOV (Metal Oxide Varistor) inside.
- Reliable supervision due to disconnection device.
- Fault indication by red indication flag in window.
- Fast response.
- With remote alarm terminal optional.

Rapid thermal disconnection under TOV ;
Inbuilt Arc - extinguishing device.



Characteristics

Type	D1-40/***-2MV-R										
	75	150	175	275	300	320	385	440	550	600	
In accordance with	IEC61643-1:2005 ; UL1449 3rd										
Category IEC/VDE	II / C										
Max. continuous operating voltage	75/100	150/200	175/225	275/300	300/385	320/420	385/505	440/585	550/745	600/800	
Nominal discharge current (8/20) In	20KA										
Max. discharge current (8/20) Imax	40KA										
Voltage protection level	@In	0.5KV	0.8KV	0.8KV	1.4KV	1.5KV	1.6KV	1.8KV	2.2KV	2.8KV	3.0KV
	@3KA	0.3KV	0.5KV	0.6KV	1.0KV	1.0KV	1.1KV	1.3KV	1.5KV	2.0KV	2.0KV
Response time	L-N	≤25 ns									
	N-PE	≤25 ns									
Follow current	L-N	No									
	N-PE	No									
Backup fuse (only required if not already provided in mains)	125A gL/gG										
Operating temperature range	- 40°C ~ + 80°C										
Cross-section of connection wire	Single-strand 35mm ² ; multi-strand 25mm ²										
Mounting	35mm DIN-rail in accordance with EN 50022/DIN46277-3										
Enclosure material	Thermoplastic ; extinguishing degree UL94 V-0										
Degree of protection	IP20										
Installation width	2 modules , DIN 43880										
Thermal disconnecter	Internal green – normal red - failure										
Remote alarm contact	Optional										
Additional data for Remote Alarm Contacts											
Remote alarm contact type	floating changeover contact										
Switching capability UN/IN	AC: 250V/0.5A DC: 250V/0.1A ; 125V/0.2A ; 75V/0.5A										
Cross-section of connection wire	Max. 1.5mm ²										

Dimensions and Diagram

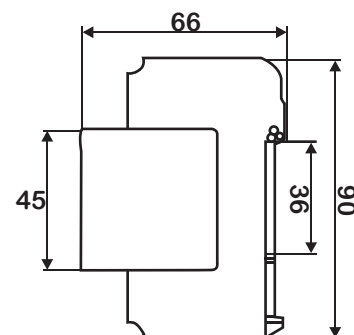
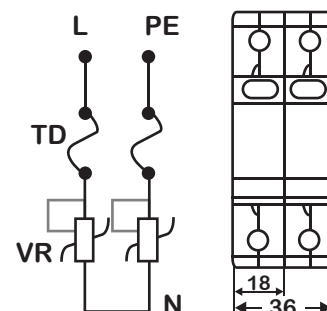

All dimension in mm

Note: Subject to change without any notice.

Single Phase (2 MOV Modules) Surge Protection Devices Type D1-50/***-2MV-R

Surge arrester for low-voltage power supply system protection against surges at the boundaries from lightning protection zone 0B-1 and higher.

- Class II (C) arrester in according with IEC61643-1:2005.
- Fail Safe System (Patent)
- Two part design consisting of base and plug-in protection module.
- High energy MOV (Metal Oxide Varistor) inside.
- Reliable supervision due to disconnection device.
- Fault indication by red indication flag in window.
- Fast response.
- With remote alarm terminal optional.

Rapid thermal disconnection under TOV ;
Inbuilt Arc - extinguishing device.



Characteristics

Type	D1-50/***-2MV-R										
	75	150	175	275	300	320	385	440	550	600	
In accordance with	IEC61643-1:2005 ; UL1449 3rd										
Category IEC/VDE	II / C										
Max. continuous operating voltage (AC/DC)	75/100	150/200	175/225	275/300	300/385	320/420	385/505	440/585	550/745	600/800	
Nominal discharge current(8/20) In	L-N	20KA									
	N-PE	20KA									
Max. discharge current(8/20) Imax	L-N	50KA									
	N - PE	50KA									
Voltage protection level	@In	0.5KV	0.8KV	0.8KV	1.4KV	1.5KV	1.6KV	1.8KV	2.2KV	2.8KV	3.0KV
	@3KA	0.3KV	0.5KV	0.6KV	1.0KV	1.0KV	1.1KV	1.3KV	1.5KV	2.0KV	2.0KV
Response time	L-N	≤25 ns									
	N-PE	≤25 ns									
Follow current	L-N	No									
	N-PE	No									
Backup fuse <small>(only required if not already provided in mains)</small>	125A gL/gG										
Operating temperature range	- 40°C~ + 80°C										
Cross-section of connection wire	Single-strand 35mm ² ; multi-strand 25mm ²										
Mounting	35mm DIN-rail in accordance with EN 50022/DIN46277-3										
Enclosure material	thermoplastic; extinguishing degree UL94 V-0										
Degree of protection	IP20										
Installation width	2 modules , DIN 43880										
Thermal disconnecter	Internal green – normal red - failure										
Remote alarm contact	Optional										
Additional data for Remote Alarm Contacts											
Remote alarm contact type	floating changeover contact										
Switching capability UN/IN	AC: 250V/0.5A DC: 250V/0.1A; 125V/0.2A; 75V/0.5A										
Cross-section of connection wire	Max. 1.5mm ²										

Dimensions and Diagram

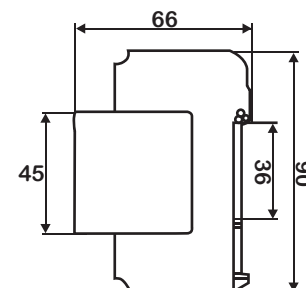
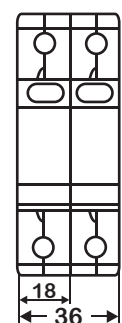
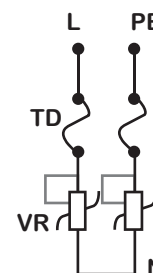

All dimension in mm

Note: Subject to change without any notice.

Single Phase (2 MOV Modules) Surge Protective Devices Type D1-60/***-2MV-R

Surge arrester for low-voltage power supply system protection against surges at the boundaries from lightning protection zone 0B-1 and higher

- Class I+II (B+C) arrester in according with IEC61643-1:2005.
- Two part design consisting of base and plug-in protection module.
- High energy MOV (Metal Oxide Varistor) inside.
- Reliable supervision due to disconnection device.
- Fault indication by red indication flag in window.
- Fast response.
- With remote alarm terminal.

Rapid thermal disconnection under TOV ;
Inbuilt Arc - extinguishing device.



Characteristics

Type	D1-60/***-2MV-R										
	75	150	175	275	300	320	385	440	550	600	
In accordance with	IEC61643-1:2005 ; UL1449 3rd										
Category IEC/VDE	I+II / B+C										
Max. continuous operating voltage (AC/DC)	75/100	150/200	175/225	275/300	300/385	320/420	385/505	440/585	550/745	600/800	
Nominal discharge current(8/20) In	L-N	30KA									
	N-PE	30KA									
Max. discharge current(8/20) I _{max}	L-N	60KA									
	N - PE	60KA									
Lightning impulse current(10/350) I _{imp}	L-N	7KA									
	N - PE	7KA									
Voltage protection level	@In	0.5KV	0.8KV	0.8KV	1.4KV	1.5KV	1.6KV	1.8KV	2.2KV	2.8KV	3.0KV
	@3KA	0.3KV	0.5KV	0.6KV	1.0KV	1.0KV	1.1KV	1.3KV	1.5KV	2.0KV	2.0KV
Response time	L-N	≤25 ns									
	N-PE	≤25 ns									
Follow current	L-N	No									
	N-PE	No									
Backup fuse <small>(only required if not already provided in mains)</small>	160A gL/gG										
Operating temperature range	- 40°C ~ + 80°C										
Cross-section of connection wire	Single-strand 35mm ² ; multi-strand 25mm ²										
Mounting	35mm DIN-rail in accordance with EN 50022 / DIN46277-3										
Enclosure material	Thermoplastic ; extinguishing degree UL94 V-0										
Degree of protection	IP20										
Installation width	2 modules , DIN 43880										
Thermal disconnecter	Internal green – normal red - failure										
Remote alarm contact	Optional										

Dimensions and Diagram

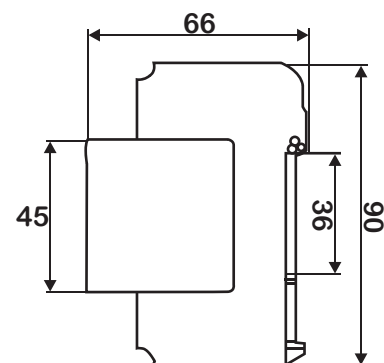
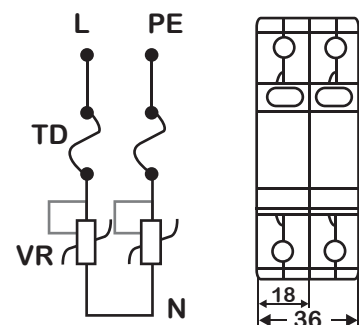

All dimension in mm

Note: Subject to change without any notice.

Single Phase (2 MOV Modules) Surge Protection Devices Type D1-80/***-2MV-R

Surge arrester for low-voltage power supply system protection against surges at the boundaries from lightning protection zone 0B-1 and higher.

- Class I+II (B+C) arrester in according with IEC61643-1:2005.
- Two part design consisting of base and non-pluggable protection module.
- High energy MOV (Metal Oxide Varistor) inside.
- Reliable supervision due to disconnection device.
- Fault indication by red indication flag in window.
- Fast response.
- With remote alarm terminal optional.



Characteristics

Type	D1-80/***-2MV-R									
	150	175	275	300	320	385	440	550	600	
In accordance with	IEC61643-1:2005 ; UL1449 3rd									
Category IEC/VDE	I+II / B+C									
Max. continuous operating voltage (AC/DC)	150/200	175/225	275/300	300/385	320/420	385/505	440/585	550/745	600/800	
Nominal discharge current(8/20) In	L-N	40KA								
	N-PE	40KA								
Max. discharge current(8/20) Imax	L-N	80KA								
	N - PE	80KA								
Lightning impulse current(10/350) Iimp	L-N	10KA								
	N - PE	10KA								
Voltage protection level	@In	0.8KV	0.8KV	1.3KV	1.4KV	1.5KV	1.8KV	2.1KV	2.8KV	3.0KV
	@3KA	0.5KV	0.6KV	1.0KV	1.0KV	1.1KV	1.3KV	1.5KV	2.0KV	2.1KV
Response time	L-N	≤25 ns								
	N-PE	≤25 ns								
Follow current	L-N	No								
	N-PE	No								
Backup fuse	200A gL/gG									
<small>(only required if not already provided in mains)</small>										
Operating temperature range	- 40°C~ + 80°C									
Cross-section of connection wire	Single-strand 35mm ² ; multi-strand 25mm ²									
Mounting	35mm DIN-rail in accordance with EN 50022 / DIN46277-3									
Enclosure material	thermoplastic; extinguishing degree UL94 V-0									
Degree of protection	IP20									
Installation width	4 modules , DIN 43880									
Thermal disconnecter	Internal green – normal red - failure									
Remote alarm contact	Optional									

Dimensions and Diagram

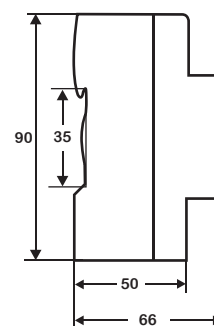
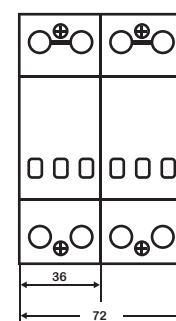
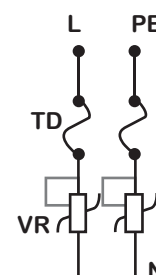

Note: Subject to change without any notice.

Single Phase (2 MOV Modules) Surge Protection Devices Type D1-100/***-2MV-R

Surge arrester for low-voltage power supply system protection against surges at the boundaries from lightning protection zone 0B-1 and higher.

- Class I+II (B+C) arrester in according with IEC61643-1:2005.
- Two part design consisting of base and non-pluggable protection module.
- High energy MOV (Metal Oxide Varistor) inside.
- Reliable supervision due to disconnection device.
- Fault indication by red indication flag in window.
- Fast response.
- With remote alarm terminal optional.



Characteristics

Type	D1-100/***-2MV-R									
	150	175	275	300	320	385	440	550	600	
In accordance with	IEC61643-1:2005 ; UL1449 3rd									
Category IEC/VDE	I+II / B+C									
Max. continuous operating Voltage (AC/DC)	150/200	175/225	275/300	300/385	320/420	385/505	440/585	550/745	600/800	
Nominal discharge current (8/20) In	L-N	50KA								
	N-PE	50KA								
Max. discharge current (8/20) Imax	L-N	100KA								
	N - PE	100KA								
Lightning impulse current (10/350) Iimp	L-N	12.5KA								
	N - PE	12.5KA								
Voltage protection level	@In	0.8KV	0.8KV	1.3KV	1.4KV	1.5KV	1.8KV	2.1KV	2.8KV	3.0KV
	@3KA	0.5KV	0.6KV	0.9KV	1.0KV	1.1KV	1.3KV	1.5KV	2.0KV	2.0KV
Response time	L-N	≤25 ns								
	N-PE	≤25 ns								
Follow current	L-N	No								
	N-PE	No								
Backup fuse <small>(only required if not already provided in mains)</small>	250A gL/gG									
Operating temperature range	- 40°C~ + 80°C									
Cross-section of connection wire	Single-strand 35mm ² ; multi-strand 25mm ²									
Mounting	35mm DIN-rail in accordance with EN 50022 / DIN46277-3									
Enclosure material	Thermoplastic ; extinguishing degree UL94 V-0									
Degree of protection	IP20									
Installation width	4 modules , DIN 43880									
Thermal disconnecter	Internal green – normal red - failure									
Remote alarm contact	Optional									

Dimensions and Diagram

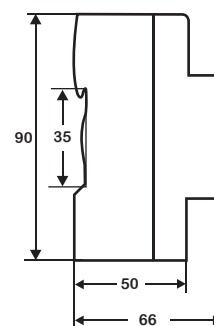
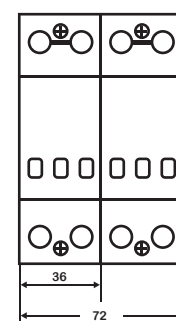
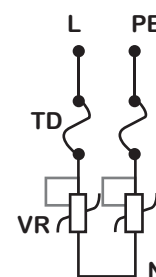

Note: Subject to change without any notice.

Single Phase (2 MOV Modules) Surge Protection Devices Type D1-120/***-2MV-R

Surge arrester for low-voltage power supply system protection against surges at the boundaries from lightning protection zone 0B-1 and higher.

- Class I+II (B+C) arrester in according with IEC61643-1:2005.
- Two part design consisting of base and non-pluggable protection module.
- High energy MOV (Metal Oxide Varistor) inside.
- Reliable supervision due to disconnection device.
- Fault indication by red indication flag in window.
- Fast response.
- With remote alarm terminal optional.



Characteristics

Type	D1-120/***-2MV-R									
	150	175	275	300	320	385	440	550	600	
In accordance with	IEC61643-1:2005 ; UL1449 3rd									
Category IEC/VDE	I+II / B+C									
Max. continuous operating voltage (AC/DC)	150/200	175/225	275/300	300/385	320/420	385/505	440/585	550/745	600/800	
Nominal discharge current(8/20) In	L-N	60KA								
	N-PE	60KA								
Max. discharge current(8/20) I _{max}	L-N	120KA								
	N-PE	120KA								
Lightning impulse current(10/350) I _{imp}	L-N	12.5KA								
	N-PE	12.5KA								
Voltage protection level	@In	0.8KV	0.8KV	1.3KV	1.4KV	1.5KV	1.8KV	2.1KV	2.8KV	3.0KV
	@3KA	0.5KV	0.6KV	0.9KV	1.0KV	1.1KV	1.3KV	1.5KV	2.0KV	2.0KV
Response time	L-N	≤25 ns								
	N-PE	≤25 ns								
Follow current	L-N	No								
	N-PE	No								
Backup fuse <small>(only required if not already provided in mains)</small>	315A gL/gG									
Operating temperature range	- 40°C ~ + 80°C									
Cross-section of connection wire	Single-strand 35mm ² ; multi-strand 25mm ²									
Mounting	35mm DIN-rail in accordance with EN 50022 / DIN46277-3									
Enclosure material	Thermoplastic ; extinguishing degree UL94 V-0									
Degree of protection	IP20									
Installation width	4 modules , DIN 43880									
Thermal disconnecter	Internal green – normal red - failure									
Remote alarm contact	Optional									

Dimensions and Diagram

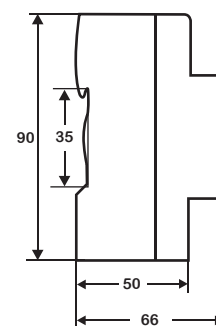
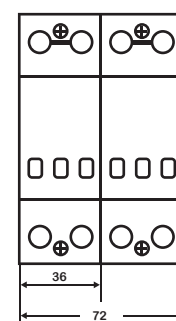
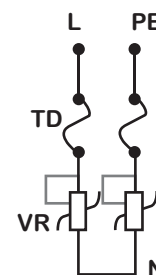

Note: Subject to change without any notice.

Single Phase (2 MOV Modules) Surge Protection Devices Type D1-150/***-2MV-R

Surge arrester for low-voltage power supply system protection against surges at the boundaries from lightning protection zone 0B-1 and higher.

- Class I+II (B+C) arrester in according with IEC61643-1:2005.
- Two part design consisting of base and non-pluggable protection module.
- High energy MOV (Metal Oxide Varistor) inside.
- Reliable supervision due to disconnection device.
- Fault indication by red indication flag in window.
- Fast response.
- With remote alarm terminal optional.



Characteristics

Type	D1-150/***-2MV-R						
	150	175	275	300	320	385	
In accordance with	IEC61643-1:2005 ; UL1449 3rd						
Category IEC/VDE	I+II / B+C						
Max. continuous operating voltage (AC/DC)	150/200	175/225	275/300	300/385	320/420	385/505	
Nominal discharge current(8/20) In	70KA						
Max. discharge current(8/20) Imax	150KA						
Lightning impulse current(10/350) Iimp	25KA						
Voltage protection level	@In	0.8KV	0.8KV	1.3KV	1.4KV	1.5KV	1.8KV
	@3KA	0.5KV	0.6KV	0.9KV	1.0KV	1.1KV	1.3KV
Response time	L-N	≤25 ns					
	N-PE	≤25 ns					
Follow current	L-N	No					
	N-PE	No					
Backup fuse <small>(only required if not already provided in mains)</small>	315A gL/gG						
Operating temperature range	- 40°C ~ + 80°C						
Cross-section of connection wire	Single-strand 35mm ² ; multi-strand 25mm ²						
Mounting	35mm DIN-rail in accordance with EN 50022 / DIN46277-3						
Enclosure material	Thermoplastic ; extinguishing degree UL94 V-0						
Degree of protection	IP20						
Installation width	4 modules , DIN 43880						
Thermal disconnecter	Internal green – normal red - failure						
Remote alarm contact	Optional						

Dimensions and Diagram

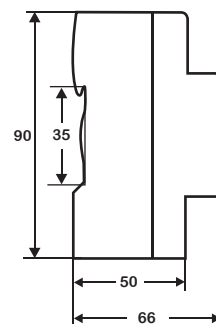
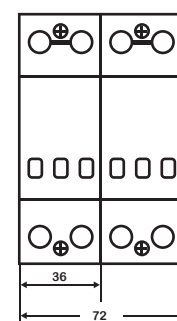
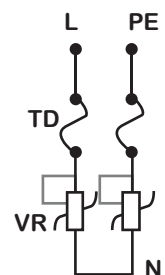

Note: Subject to change without any notice.

Three Phase (4 MOV Modules) Surge Protection Devices Type D3-25/***-4MV-R

Surge arrester for low-voltage power supply system protection against surges at the boundaries from lightning protection zone 0B-1 and higher.

- Class II (C) arrester in according with IEC61643-1:2005.
- Two part design consisting of base and plug-in protection module.
- High energy MOV (Metal Oxide Varistor) inside.
- Reliable supervision due to disconnection device.
- Fault indication by red indication flag in window.
- Fast response.
- With remote alarm terminal optional.

Rapid thermal disconnection under TOV ;
Inbuilt Arc - extinguishing device.

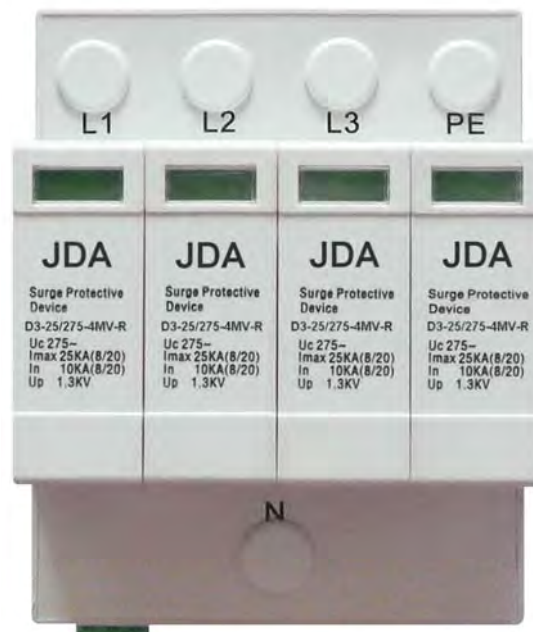

Characteristics

Type	D3-25/***-4MV-R										
	75	150	175	275	300	320	385	440	550	600	
In accordance with	IEC61643-1:2005 ; UL1449 3rd										
Category IEC/VDE	II / C										
Max. continuous operating voltage (AC/DC)	75/100	150/200	175/225	275/300	300/385	320/420	385/505	440/585	550/745	600/800	
Nominal discharge current(8/20) In	L-N		10KA								
Max. discharge current(8/20) I _{max}	N-PE		10KA								
Max. discharge current(8/20) I _{max}	L-N		25KA								
Voltage protection level	N - PE		25KA								
	@In	0.4KV	0.8KV	0.8KV	1.2KV	1.3KV	1.4KV	1.8KV	2.0KV	2.5KV	2.6KV
Response time	@3KA	0.25KV	0.5KV	0.6KV	0.9KV	1.0KV	1.1KV	1.3KV	1.5KV	2.0KV	2.1KV
	L-N	≤25 ns									
Follow current	N-PE	≤25 ns									
	L-N	No									
Backup fuse	N-PE	No									
	(only required if not already provided in mains)	100A gL/gG									
Operating temperature range	- 40°C ~ + 80°C										
Cross-section of connection wire	Single-strand 35mm ² ; multi-strand 25mm ²										
Mounting	35mm DIN-rail in accordance with EN 50022 / DIN46277-3										
Enclosure material	Thermoplastic ; extinguishing degree UL94 V-0										
Degree of protection	IP20										
Installation width	4 modules , DIN 43880										
Thermal disconnecter	Internal green – normal red - failure										
Remote alarm contact	Optional										

Dimensions and Diagram

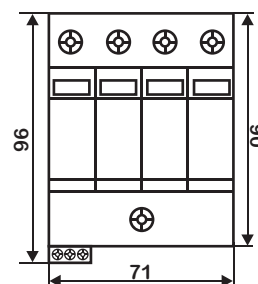
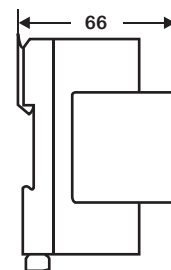
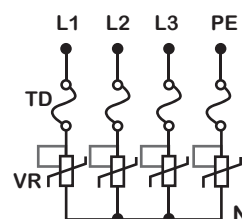

Note: Subject to change without any notice.

Three Phase (4 MOV Modules) Surge Protection Devices Type D3-40/***-4MV-R

Surge arrester for low-voltage power supply system protection against surges at the boundaries from lightning protection zone 0B-1 and higher.

- Class II (C) arrester in according with IEC61643-1:2005.
- Two part design consisting of base and plug-in protection module.
- High energy MOV (Metal Oxide Varistor) inside.
- Reliable supervision due to disconnection device.
- Fault indication by red indication flag in window.
- Fast response.
- With remote alarm terminal optional.

Rapid thermal disconnection under TOV ;
Inbuilt Arc - extinguishing device.

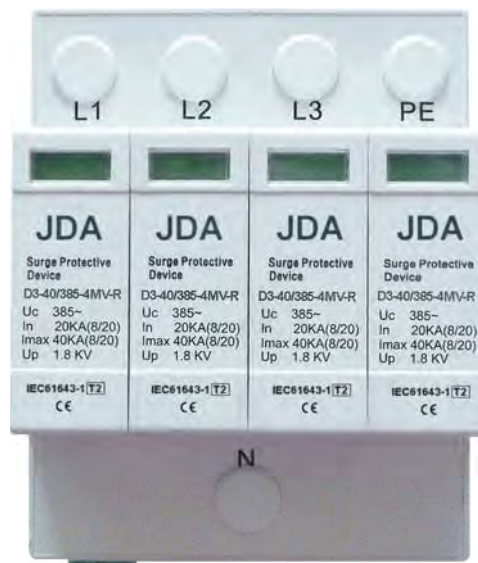

Characteristics

Type	D3-40/***-4MV-R										
	75	150	175	275	300	320	385	440	550	600	
In accordance with	IEC61643-1:2005 ; UL1449 3rd										
Category IEC/VDE	II / C										
Max. continuous operating voltage (AC/DC)	75/100	150/200	175/225	275/300	300/385	320/420	385/505	440/585	550/745	600/800	
Nominal discharge current (8/20) In	L-N		20KA								
Max. discharge current (8/20) Imax	N-PE		20KA								
Nominal discharge current (8/20) I _{max}	L-N		40KA								
Voltage protection level	N-PE		40KA								
Response time	@In	0.5KV	0.8KV	0.8KV	1.4KV	1.5KV	1.6KV	1.8KV	2.2KV	2.8KV	3.0KV
Follow current	@3KA	0.3KV	0.5KV	0.6KV	1.0KV	1.0KV	1.1KV	1.3KV	1.5KV	2.0KV	2.0KV
Backup fuse	L-N	≤25 ns									
	N-PE	≤25 ns									
Operating temperature range	L-N	No									
	N-PE	No									
Cross-section of connection wire	125A gL/gG										
Mounting	- 40°C~ + 80°C										
Enclosure material	Single-strand 35mm ² ; multi-strand 25mm ²										
Degree of protection	35mm DIN-rail in accordance with EN 50022/DIN46277-3										
Installation width	Thermoplastic ; extinguishing degree UL94 V-0										
Thermal disconnecter	IP20										
Remote alarm contact	4 modules , DIN 43880										
	Internal green – normal red - failure										
	Optional										

Dimensions and Diagram

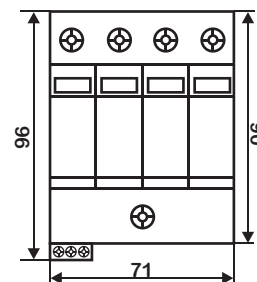
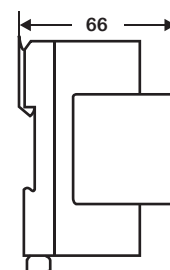
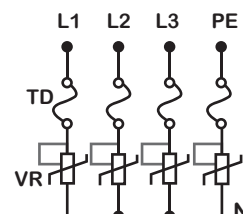

Note: Subject to change without any notice.

Three Phase (4 MOV Modules) Surge Protection Devices Type D3-50/***-4MV-R

Surge arrester for low-voltage power supply system protection against surges at the boundaries from lightning protection zone 0B-1 and higher.

- Class II (C) arrester in according with IEC61643-1:2005.
- Two part design consisting of base and plug-in protection module.
- High energy MOV (Metal Oxide Varistor) inside.
- Reliable supervision due to disconnection device.
- Fault indication by red indication flag in window.
- Fast response.
- With remote alarm terminal optional.

Rapid thermal disconnection under TOV ;
Inbuilt Arc - extinguishing device.

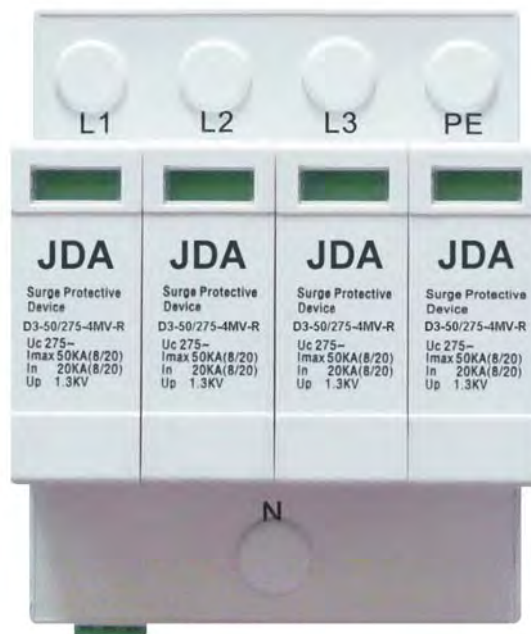

Characteristics

Type	D3-50/***-4MV-R										
	75	150	175	275	300	320	385	440	550	600	
In accordance with	IEC61643-1:2005 ; UL1449 3rd										
Category IEC/VDE	II / C										
Max. continuous operating voltage (AC/DC)	75/100	150/200	175/225	275/300	300/385	320/420	385/505	440/585	550/745	600/800	
Nominal discharge current(8/20) In	L-N				20KA						
	N-PE				20KA						
Max. discharge current(8/20) Imax	L-N				50KA						
	N - PE				50KA						
Voltage protection level	@In	0.5KV	0.8KV	0.8KV	1.3KV	1.5KV	1.5KV	1.8KV	2.2KV	2.8KV	3.0KV
	@3KA	0.3KV	0.5KV	0.6KV	1.0KV	1.0KV	1.1KV	1.3KV	1.5KV	2.0KV	2.0KV
Response time	L-N	≤25 ns									
	N-PE	≤25 ns									
Follow current	L-N	No									
	N-PE	No									
Backup fuse	125A gL/gG										
(only required if not already provided in mains)											
Operating temperature range	- 40°C~ + 80°C										
Cross-section of connection wire	Single-strand 35mm ² ; multi-strand 25mm ²										
Mounting	35mm DIN-rail in accordance with EN 50022 / DIN46277-3										
Enclosure material	Thermoplastic ; extinguishing degree UL94 V-0										
Degree of protection	IP20										
Installation width	4 modules , DIN 43880										
Thermal disconnecter	Internal green – normal red - failure										
Remote alarm contact	Optional										

Dimensions and Diagram

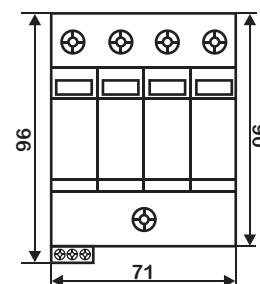
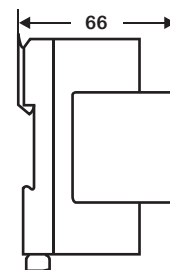
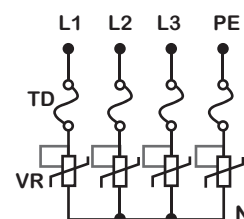

Note: Subject to change without any notice.

Three Phase (4 MOV Modules) Surge Protection Devices Type D3-60/***-4MV-R

Surge arrester for low-voltage power supply system protection against surges at the boundaries from lightning protection zone 0B-1 and higher.

- Class I+II (B+C) arrester in according with IEC61643-1:2005.
- Two part design consisting of base and plug-in protection module.
- High energy MOV (Metal Oxide Varistor) inside.
- Reliable supervision due to disconnection device.
- Fault indication by red indication flag in window.
- Fast response.
- With remote alarm terminal optional.

Rapid thermal disconnection under TOV ;
Inbuilt Arc - extinguishing device.



Characteristics

Type	D3-60/***-4MV-R										
	75	150	175	275	300	320	385	440	550	600	
In accordance with	IEC61643-1:2005 ; UL1449 3rd										
Category IEC/VDE	I+II / B+C										
Max. continuous operating voltage (AC/DC)	75/100	150/200	175/225	275/300	300/385	320/420	385/505	440/585	550/745	600/800	
Nominal discharge current(8/20) In	30KA										
Max. discharge current(8/20) Imax	60KA										
Lightning impulse current(10/350) Iimp	7KA										
Voltage protection level	@In	0.5KV	0.8KV	0.8KV	1.3KV	1.4KV	1.5KV	1.8KV	2.2KV	2.8KV	3.0KV
	@3KA	0.3KV	0.5KV	0.6KV	1.0KV	1.0KV	1.1KV	1.3KV	1.5KV	2.0KV	2.1KV
Response time	L-N	≤25 ns									
	N-PE	≤25 ns									
Follow current	L-N	No									
	N-PE	No									
Backup fuse	160A gL/gG										
(only required if not already provided in mains)											
Operating temperature range	- 40°C ~ + 80°C										
Cross-section of connection wire	Single-strand 35mm ² ; multi-strand 25mm ²										
Mounting	35mm DIN-rail in accordance with EN 50022 / DIN46277-3										
Enclosure material	Thermoplastic ; extinguishing degree UL94 V-0										
Degree of protection	IP20										
Installation width	4 modules , DIN 43880										
Thermal disconnecter	Internal green – normal red - failure										
Remote alarm contact	Optional										

Dimensions and Diagram

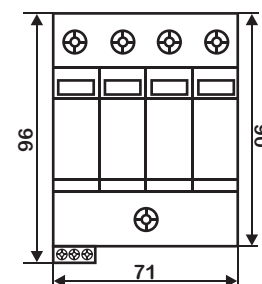
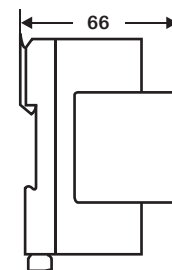
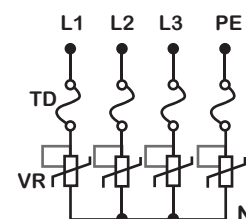

Note: Subject to change without any notice.

Three Phase (4 MOV Modules) Surge Protection Devices Type D3-80/***-4MV-R

Surge arrester for low-voltage power supply system protection against surges at the boundaries from lightning protection zone 0B-1 and higher.

- Class I+II (B+C) arrester in according with IEC61643-1:2005.
- Two part design consisting of base and non-pluggable protection module.
- High energy MOV (Metal Oxide Varistor) inside.
- Reliable supervision due to disconnection device.
- Fault indication by red indication flag in window.
- Fast response.
- With remote alarm terminal optional..

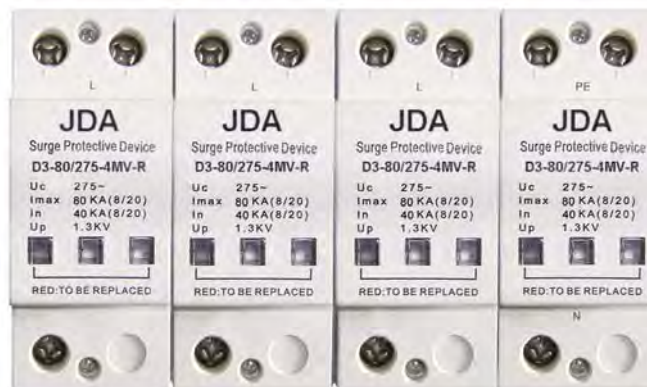

Characteristics

Type	D3-80/***-4MV-R									
	150	175	275	300	320	385	440	550	600	
In accordance with	IEC61643-1:2005 ; UL1449 3rd									
Category IEC/VDE	I+II / B+C									
Max. continuous operating voltage (AC/DC)	150/200	175/225	275/300	300/385	320/420	385/505	440/585	550/745	600/800	
Nominal discharge current(8/20) In	L-N			40KA						
Max. discharge current(8/20) Imax	N-PE			80KA						
Lightning impulse current(10/350) Iimp	L-N			10KA						
Voltage protection level	@In	0.8KV	0.8KV	1.3KV	1.4KV	1.5KV	1.8KV	2.1KV	2.8KV	3.0KV
	@3KA	0.5KV	0.6KV	1.0KV	1.0KV	1.1KV	1.3KV	1.5KV	2.0KV	2.1KV
Response time	L-N	≤25 ns								
	N-PE	≤25 ns								
Follow current	L-N	No								
	N-PE	No								
Backup fuse	200A gL/gG									
(only required if not already provided in mains)										
Operating temperature range	- 40°C~ + 80°C									
Cross-section of connection wire	Single-strand 35mm ² ; multi-strand 25mm ²									
Mounting	35mm DIN-rail in accordance with EN 50022 / DIN46277-3									
Enclosure material	Thermoplastic ; extinguishing degree UL94 V-0									
Degree of protection	IP20									
Installation width	8 modules , DIN 43880									
Thermal disconnecter	Internal green – normal red - failure									
Remote alarm contact	Optional									

Dimensions and Diagram

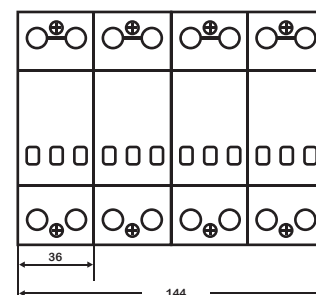
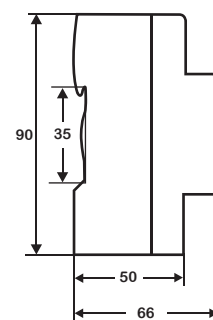
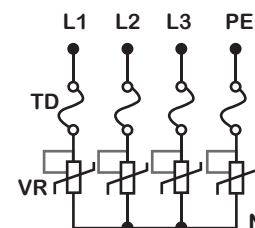

Note: Subject to change without any notice.

Three Phase (4 MOV Modules) Surge Protection Devices Type D3-100/***-4MV-R

Surge arrester for low-voltage power supply system protection against surges at the boundaries from lightning protection zone 0B-1 and higher.

- Class I+II (B+C) arrester in according with IEC61643-1:2005.
- Two part design consisting of base and non-pluggable protection module.
- High energy MOV (Metal Oxide Varistor) inside.
- Reliable supervision due to disconnection device.
- Fault indication by red indication flag in window.
- Fast response.
- With remote alarm terminal optional.

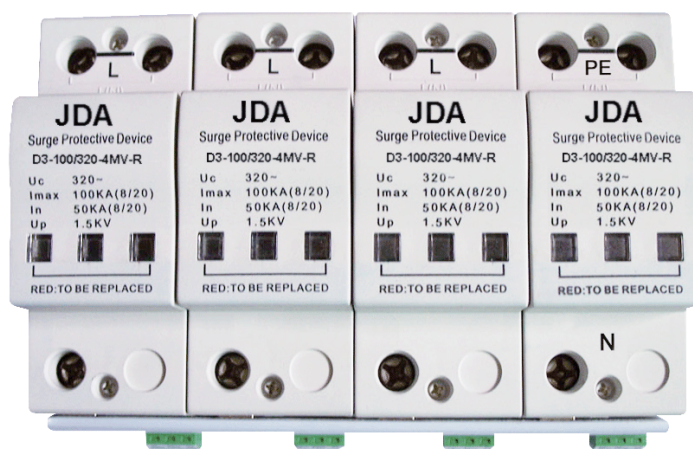

Characteristics

Type	D3-100/***-4MV-R									
	150	175	275	300	320	385	440	550	600	
In accordance with	IEC61643-1:2005 ; UL1449 3rd									
Category IEC/VDE	I+II / B+C									
Max. continuous operating voltage (AC/DC)	150/200	175/225	275/300	300/385	320/420	385/505	440/585	550/745	600/800	
Nominal discharge current(8/20) In	L-N				50KA					
Max. discharge current(8/20) Imax	N-PE				100KA					
Lightning impulse current (10/350) Iimp	L-N				12.5KA					
Voltage protection level	@In	0.8KV	0.8KV	1.3KV	1.4KV	1.5KV	1.8KV	2.1KV	2.8KV	3.0KV
	@3KA	0.5KV	0.6KV	0.9KV	1.0KV	1.1KV	1.3KV	1.5KV	2.0KV	2.0KV
Response time	L-N	≤25 ns								
	N-PE	≤25 ns								
Follow current	L-N	No								
	N-PE	No								
Backup fuse	250A gL/gG									
(only required if not already provided in mains)										
Operating temperature range	- 40°C ~ + 80°C									
Cross-section of connection wire	Single-strand 35mm ² ; multi-strand 25mm ²									
Mounting	35mm DIN-rail in accordance with EN 50022 / DIN46277-3									
Enclosure material	Thermoplastic ; extinguishing degree UL94 V-0									
Degree of protection	IP20									
Installation width	8 modules , DIN 43880									
Thermal disconnecter	Internal green – normal red - failure									
Remote alarm contact	Optional									

Dimensions and Diagram

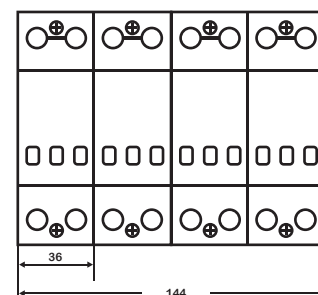
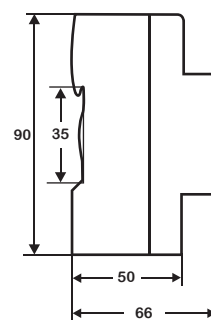
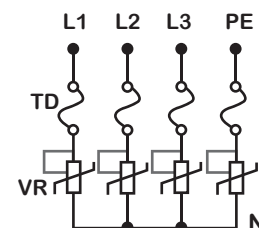

Note: Subject to change without any notice.

Three Phase (4 MOV Modules) Surge Protection Devices Type D3-120/***-4MV-R

Surge arrester for low-voltage power supply system protection against surges at the boundaries from lightning protection zone 0B-1 and higher.

- Class I+II (B+C) arrester in according with IEC61643-1:2005.
- Two part design consisting of base and non-pluggable protection module.
- High energy MOV (Metal Oxide Varistor) inside.
- Reliable supervision due to disconnection device.
- Fault indication by red indication flag in window.
- Fast response.
- With remote alarm terminal optional.



Characteristics

Type	D3-120/***-4MV-R									
	150	175	275	300	320	385	440	550	600	
In accordance with	IEC61643-1:2005 ; UL1449 3rd									
Category IEC/VDE	I+II / B+C									
Max. continuous operating Voltage (AC/DC)	150/200	175/225	275/300	300/385	320/420	385/505	440/585	550/745	600/800	
Nominal discharge current (8/20) In	L-N				60KA					
	N-PE				60KA					
Max. discharge current (8/20) I _{max}	L-N				120KA					
	N - PE				120KA					
Lightning impulse current (10/350) I _{imp}	L-N				12.5KA					
	N - PE				12.5KA					
Voltage protection level	@In	0.8KV	0.8KV	1.3KV	1.4KV	1.5KV	1.8KV	2.1KV	2.8KV	3.0KV
	@3KA	0.5KV	0.6KV	0.9KV	1.0KV	1.1KV	1.3KV	1.5KV	2.0KV	2.0KV
Response time	L-N	≤25 ns								
	N-PE	≤25 ns								
Follow current	L-N	No								
	N-PE	No								
Backup fuse	315A gL/gG									
(only required if not already provided in mains)										
Operating temperature range	- 40°C ~ + 80°C									
Cross-section of connection wire	Single-strand 35mm ² ; multi-strand 25mm ²									
Mounting	35mm DIN-rail in accordance with EN 50022/DIN46277-3									
Enclosure material	Thermoplastic ; extinguishing degree UL94 V-0									
Degree of protection	IP20									
Installation width	8 modules , DIN 43880									
Thermal disconnecter	Internal green – normal red - failure									
Remote alarm contact	Optional									

Dimensions and Diagram

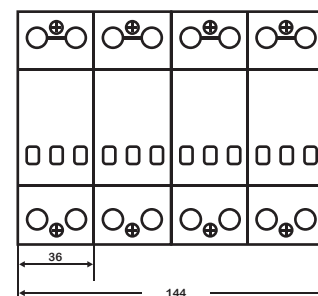
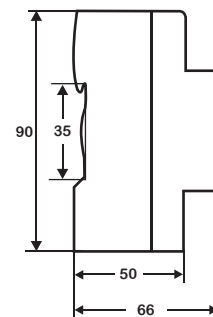
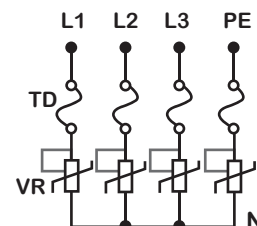

Note: Subject to change without any notice.

Three Phase (4 MOV Modules) Surge Protection Devices Type D3-150/***-4MV-R

Surge arrester for low-voltage power supply system protection against surges at the boundaries from lightning protection zone 0B-1 and higher.

- Class I+II (B+C) arrester in according with IEC61643-1:2005.
- Two part design consisting of base and non-pluggable protection module.
- High energy MOV (Metal Oxide Varistor) inside.
- Reliable supervision due to disconnection device.
- Fault indication by red indication flag in window.
- Fast response.
- With remote alarm terminal optional.



Characteristics

Type	D3-150/***-4MV-R						
	150	175	275	300	320	385	
In accordance with	IEC61643-1:2005 ; UL1449 3rd						
Category IEC/VDE	I+II / B+C						
Max. continuous operating voltage (AC/DC)	150/200	175/225	275/300	300/385	320/420	385/505	
Nominal discharge current (8/20) In	70KA			70KA			
Max. discharge current (8/20) Imax	150KA			150KA			
Lightning impulse current (10/350) Iimp	25KA			25KA			
Voltage protection level	@In	0.8KV	0.8KV	1.3KV	1.4KV	1.5KV	1.8KV
	@3KA	0.5KV	0.6KV	0.9KV	1.0KV	1.1KV	1.3KV
Response time	L-N					≤25 ns	
	N-PE					≤25 ns	
Follow current	L-N					No	
	N-PE					No	
Backup fuse (only required if not already provided in mains)	315A gL/gG						
Operating temperature range	- 40°C~ + 80°C						
Cross-section of connection wire	Single-strand 35mm ² ; multi-strand 25mm ²						
Mounting	35mm DIN-rail in accordance with EN 50022 / DIN46277-3						
Enclosure material	Thermoplastic ; extinguishing degree UL94 V-0						
Degree of protection	IP20						
Installation width	8 modules , DIN 43880						
Thermal disconnecter	Internal green – normal red - failure						
Remote alarm contact	Optional						

Dimensions and Diagram

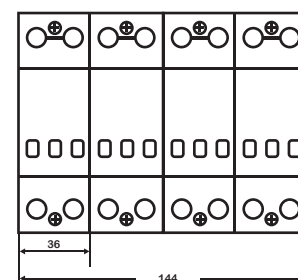
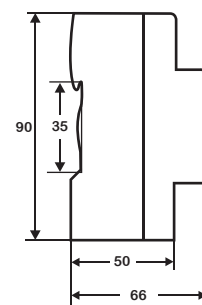
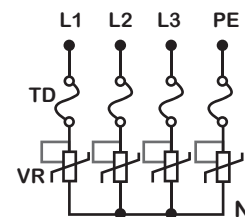

Note: Subject to change without any notice.

MOV Module Surge Protection Devices Type MV25/***-R

MOV Module Surge Protection Devices

- Class II (C) arrester in according with IEC61643-1:2005.
- Two part design consisting of base and plug-in protection module.
- High energy MOV (Metal Oxide Varistor) inside.
- Reliable supervision due to disconnection device.
- Fault indication by red indication flag in window.
- Fast response.
- With remote alarm terminal optional.

Rapid thermal disconnection under TOV ;
Inbuilt Arc - extinguishing device.



Dimensions and Diagram

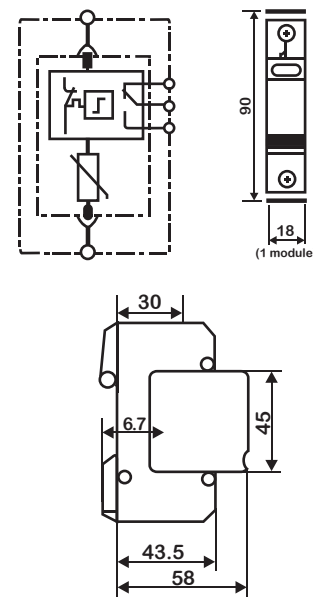

Characteristics

Type	MV 25/***-R										
	75	150	175	275	300	320	385	440	550	600	
In accordance with	IEC61643-1:2005 ; UL1449 3rd										
Category IEC/VDE	II/ C										
Max. continuous operating voltage (AC/DC)	75/100	150/200	175/225	275/300	300/385	320/420	385/505	440/585	550/745	600/800	
Nominal discharge current (8/20) In	10KA										
Max. discharge current (8/20) Imax	25KA										
Voltage protection level at In	0.4KV	0.8KV	0.8KV	1.3KV	1.3KV	1.5KV	1.8KV	2.0KV	2.5KV	2.6KV	
Let through voltage @3KA (8/20)	0.25KV	0.5KV	0.6KV	0.9KV	1.0KV	1.1KV	1.3KV	1.5KV	2.0KV	2.1KV	
Response time	≤25 ns										
Follow current	No										
Backup fuse <small>(only required if not already provided in mains)</small>	100A gL/gG										
Operating temperature range	- 40°C~ + 80°C										
Cross-section of connection wire	Single-strand 35mm ² ; multi-strand 25mm ²										
Mounting	35mm DIN-rail in accordance with EN 50022/DIN46277-3										
Enclosure material	thermoplastic; extinguishing degree UL94 V-0										
Degree of protection	IP20										
Installation width	1 module , DIN 43880										
Thermal disconnect	Internal green – normal red - failure										
Remote alarm contact	Optional										
Additional data for Remote Alarm Contacts											
Remote alarm contact type	floating changeover contact										
Switching capability U _N /I _N	AC: 250V/0.5A					DC: 250V/0.1A ; 125V/0.2A ; 75V/0.5A					
Cross-section of connection wire	Max. 1.5mm ²										

Note: Subject to change without any notice.

Class II Surge Protective Device Type MV40/***-R

Dimensions and Diagram

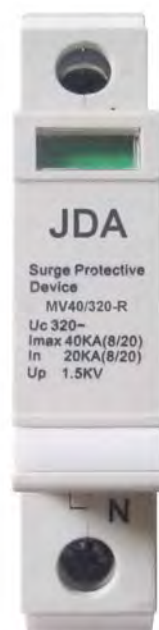
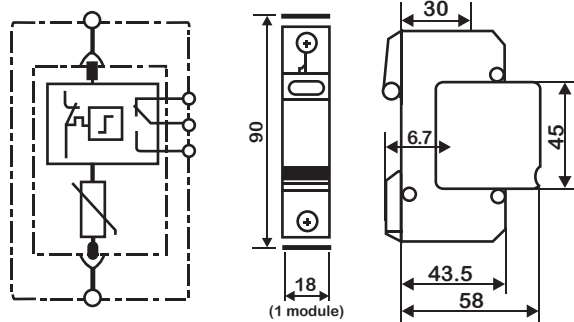

IEC61643-1; UL1449 3rd

- Fail Safe System (Patent)
- Uc: ac: 75-690V
- Imax 5KA-60KA (8/20 μ S)
- pluggable type, replaceable
- Fault indication window
- With remote signaling contact optional.

Rapid thermal disconnection under TOV ;
Inbuilt Arc - extinguishing device.

Characteristics

Type	MV 40/***-R									
	150	175	275	300	320	385	420	510	550	690
In accordance with	IEC61643-1:2005 ; UL1449 3rd									
Category IEC	II									
Max. continuous operating voltage (AC/DC)	150/200	175/225	275/350	300/385	320/420	385/505	420/560	510/670	550/745	690/910
Nominal discharge current (8/20) In	20KA									
Max. discharge current(8/20) Imax	40KA									
Voltage protection level at In	0.8KV	0.8KV	1.3KV	1.5KV	1.5KV	1.6KV	2.2KV	2.4KV	2.8KV	3.0KV
VPR @6KV/3KA	0.6KV	0.6KV	1.0KV	1.0KV	1.2KV	1.4KV	1.5KV	1.6KV	1.8KV	2.0KV
Response time	≤25 ns									
Backup fuse (only required if not already provided in mains)	125A gL/gG									
Operating temperature range	- 40°C ~ + 80°C									
Cross-section of connection wire	Single-strand 35mm ² ; multi-strand 25mm ²									
Mounting	35mm DIN-rail in accordance with EN 50022/DIN46277-3									
Enclosure material	Thermoplastic ; extinguishing degree UL94 V-0									
Degree of protection	IP20									
Installation width	1 module , DIN 43880									
Thermal disconnect	Internal green – normal red - failure									
Remote alarm contact	Optional									
Additional data for Remote Alarm Contacts										
Remote alarm contact type	floating changeover contact									
Switching capability U _N /I _N	AC: 250V/0.5A					DC: 250V/0.1A ; 125V/0.2A ; 75V/0.5A				
Cross-section of connection wire	Max. 1.5mm ²									

Note: Subject to change without any notice.

MOV Module Surge Protection Devices Type MV50/***-R

Dimensions and Diagram

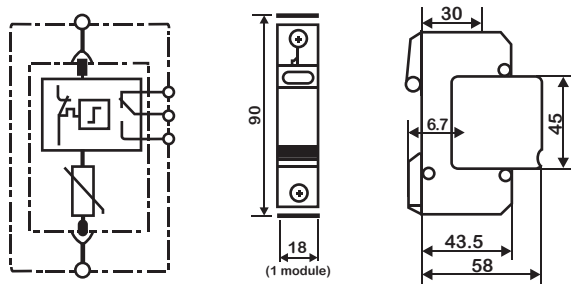

- Class II (C) arrester in according with IEC61643-1:2005.
- Fail Safe System (Patent)
- Two part design consisting of base and plug-in protection module.
- High energy MOV (Metal Oxide Varistor) inside.
- Reliable supervision due to disconnection device.
- Fault indication by red indication flag in window.
- Fast response.
- With remote alarm terminal optional.

Rapid thermal disconnection under TOV ;
Inbuilt Arc - extinguishing device.

Characteristics

Type	MV 50/***-R									
	75	150	175	275	300	320	385	440	550	600
In accordance with	IEC61643-1:2005 ; UL1449 3rd									
Category IEC/VDE	II / C									
Max. continuous operating voltage (AC/DC)	75/100	150/200	175/225	275/300	300/385	320/420	385/505	440/585	550/745	600/800
Nominal discharge current (8/20) In	20KA									
Max. discharge current (8/20) Imax	50KA									
Voltage protection level at In	0.5KV	0.8KV	0.8KV	1.3KV	1.3KV	1.5KV	1.6KV	2.2KV	2.8KV	3.0KV
Let through voltage @3KA (8/20)	0.3KV	0.5KV	0.6KV	1.0KV	1.0KV	1.0KV	1.3KV	1.5KV	2.0KV	2.0KV
Response time	≤25 ns									
Follow current	No									
Backup fuse <small>(only required if not already provided in mains)</small>	125A gL/gG									
Operating temperature range	- 40°C ~ + 80°C									
Cross-section of connection wire	Single-strand 35mm ² ; multi-strand 25mm ²									
Mounting	35mm DIN-rail in accordance with EN 50022 /DIN46277-3									
Enclosure material	Thermoplastic ; extinguishing degree UL94 V-0									
Degree of protection	IP20									
Installation width	1 module , DIN 43880									
Thermal disconnecter	Internal green – normal red - failure									
Remote alarm contact	Optional									
Additional data for Remote Alarm Contacts										
Remote alarm contact type	floating changeover contact									
Switching capability U _N /I _N	AC: 250V/0.5A					DC: 250V/0.1A ; 125V/0.2A ; 75V/0.5A				
Cross-section of connection wire	Max. 1.5mm ²									

Note: Subject to change without any notice.

MOV Module Surge Protection Devices Type MV60/***-R

Dimensions and Diagram

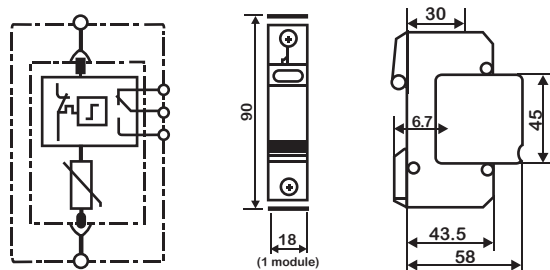

MOV Module Surge Protection Devices

- Class I+ II (B+C) arrester in according with IEC61643-1:2005.
- Two part design consisting of base and plug-in protection module.
- High energy MOV (Metal Oxide Varistor) inside.
- Reliable supervision due to disconnection device.
- Fault indication by red indication flag in window.
- Fast response.
- With remote alarm terminal optional.

Rapid thermal disconnection under TOV ;
Inbuilt Arc - extinguishing device.

Characteristics

Type	MV 60/***-R									
	75	150	175	275	300	320	385	440	550	600
In accordance with	IEC61643-1:2005 ; UL1449 3rd									
Category IEC/VDE	I+II / B+C									
Max. continuous operating voltage (AC/DC)	75/100	150/200	175/225	275/300	300/385	320/420	385/505	440/585	550/745	600/800
Nominal discharge current (8/20) In	30KA									
Max. discharge current (8/20) I _{max}	60KA									
Lightning impulse current (10/350) I _{imp}	7KA									
Voltage protection level at In	0.5KV	0.8KV	0.8KV	1.3KV	1.5KV	1.5KV	1.8KV	2.2KV	2.8KV	3.0KV
Let through voltage @3KA 8/20	0.3KV	0.5KV	0.6KV	1.0KV	1.0KV	1.1KV	1.3KV	1.5KV	2.0KV	2.1KV
Response time	≤25 ns									
Follow current	No									
Backup fuse (only required if not already provided in mains)	160A gL/gG									
Operating temperature range	- 40°C ~ + 80°C									
Cross-section of connection wire	Single-strand 35mm ² ; multi-strand 25mm ²									
Mounting	35mm DIN-rail in accordance with EN 50022 /DIN46277-3									
Enclosure material	Thermoplastic ; extinguishing degree UL94 V-0									
Degree of protection	IP20									
Installation width	1 module , DIN 43880									
Thermal disconnecter	Internal green – normal red - failure									
Remote alarm contact	Optional									
Additional data for Remote Alarm Contacts										
Remote alarm contact type	floating changeover contact									
Switching capability U _N /I _N	AC: 250V/0.5A					DC: 250V/0.1A ; 125V/0.2A ; 75V/0.5A				
Cross-section of connection wire	Max. 1.5mm ²									

Note: Subject to change without any notice.

MOV Module Surge Protection Devices Type MV80/***-R

Surge arrester for low-voltage power supply system protection against surges at the boundaries from lightning protection zone 0B-1 and higher.

- Class I+II (B+C) arrester in according with IEC61643-1:2005.
- Two part design consisting of base and non-pluggable protection module.
- High energy MOV (Metal Oxide Varistor) inside.
- Reliable supervision due to disconnection device.
- Fault indication by red indication flag in window.
- Fast response.
- With remote alarm terminal optional.



Characteristics

Type	MV 80/***-R								
	150	175	275	300	320	385	440	550	600
In accordance with	IEC61643-1:2005 ; UL1449 3rd								
Category IEC/VDE	I+II / B+C								
Max. continuous operating voltage (AC/DC)	150	175	275	300	320	385	440	550	600
Nominal discharge current (8/20) In	/200	/225	/300	/385	/420	/505	/585	/745	/800
Max. discharge current (8/20) Imax	40kA								
Lightning impulse current(10/350) Iimp	80kA								
Voltage protection level at In	0.8kV	0.8kV	1.3kV	1.4kV	1.5kV	1.8kV	2.1kV	2.8kV	3.0kV
Let through voltage @3kA 8/20	0.5kV	0.6kV	1.0kV	1.0kV	1.1kV	1.3kV	1.5kV	2.0kV	2.1kV
Response time	≤25 ns								
Follow current	No								
Backup fuse (only required if not already provided in mains)	200A gL/gG								
Operating temperature range	- 40°C ~ + 80°C								
Cross-section of connection wire	Single-strand 35mm ² ; multi-strand 25mm ²								
Mounting	35mm DIN-rail in accordance with EN 50022/DIN46277-3								
Enclosure material	thermoplastic; extinguishing degree UL94 V-0								
Degree of protection	IP20								
Installation width	2 modules , DIN 43880								
Thermal disconnecter	Internal green – normal red - failure								
Remote alarm contact	Optional								
Additional data for Remote Alarm Contacts									
Remote alarm contact type	floating changeover contact								
Switching capability UN/IN	AC: 250V/0.5A DC: 250V/0.1A ; 125V/0.2A ; 75V/0.5A								
Cross-section of connection wire	Max. 1.5mm ²								

Dimensions and Diagram

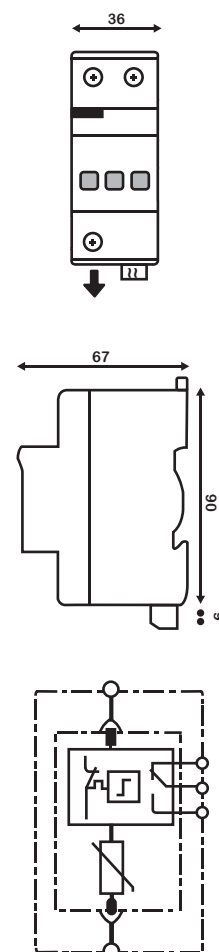

Note: Subject to change without any notice.

MOV Module Surge Protection Devices Type MV100/***-R

- Class I+ II (B+C) arrester in according with IEC61643-1:2005.
- Two part design consisting of base and non-pluggable protection module.
- High energy MOV (Metal Oxide Varistor) inside.
- Reliable supervision due to disconnection device.
- Fault indication by red indication flag in window.
- Fast response.
- With remote alarm terminal optional.

Dimensions and Diagram

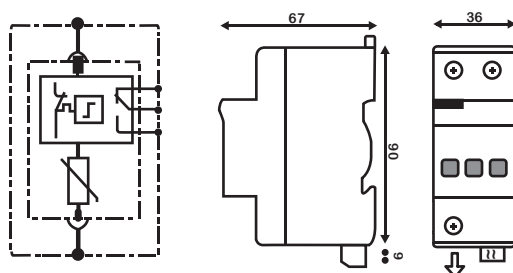

Surge arrester for low-voltage power supply system protection against surges at the boundaries from lightning protection zone 0B-1 and higher.

Characteristics

Type	MV 100/***-R									
	150	175	275	300	320	385	440	550	600	150
In accordance with	IEC61643-1:2005 ; UL1449 3rd									
Category IEC/VDE	I+II / B+C									
Max. continuous operating voltage (AC/DC)	150/200	175/225	275/300	300/385	320/420	385/505	440/585	550/745	600/800	150/200
Nominal discharge current (8/20) In	50KA									
Max. discharge current (8/20) Imax	100KA									
Lightning impulse current (10/350) Iimp	12.5KA									
Voltage protection level at In	0.8KV	0.8KV	1.3KV	1.4KV	1.5KV	1.8KV	2.1KV	2.8KV	3.0KV	0.8KV
Let through voltage @3KA 8/20	0.5KV	0.6KV	0.9KV	1.0KV	1.1KV	1.3KV	1.5KV	2.0KV	2.0KV	0.5KV
Response time	≤25 ns									
Follow current	No									
Backup fuse <small>(only required if not already provided in mains)</small>	250A gL/gG									
Operating temperature range	- 40°C~ + 80°C									
Cross-section of connection wire	Single-strand 35mm ² ; multi-strand 25mm ²									
Mounting	35mm DIN-rail in accordance with EN 50022 /DIN46277-3									
Enclosure material	Thermoplastic ; extinguishing degree UL94 V-0									
Degree of protection	IP20									
Installation width	2 modules , DIN 43880									
Thermal disconnecter	Internal green – normal red - failure									
Remote alarm contact	Optional									
Additional data for Remote Alarm Contacts										
Remote alarm contact type	floating changeover contact									
Switching capability U _N /I _N	AC: 250V/0.5A					DC: 250V/0.1A ; 125V/0.2A ; 75V/0.5A				
Cross-section of connection wire	Max. 1.5mm ²									

Note: Subject to change without any notice.

MOV Module Surge Protection Devices Type MV120/***-R

- Class I+II (B+C) arrester in according with IEC61643-1:2005.
- Two part design consisting of base and non-pluggable protection module.
- High energy MOV (Metal Oxide Varistor) inside.
- Reliable supervision due to disconnection device.
- Fault indication by red indication flag in window.
- Fast response.
- With remote alarm terminal optional.

Dimensions and Diagram

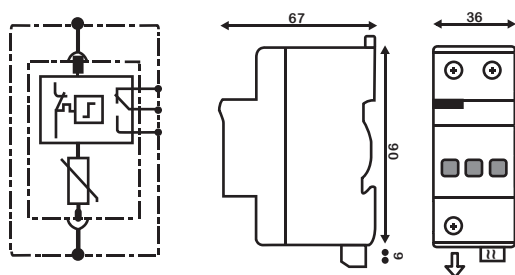

Surge arrester for low-voltage power supply system protection against surges at the boundaries from lightning protection zone 0B-1 and higher.

Characteristics

Type	MV 120/***-R									
	150	175	275	300	320	385	440	550	600	150
In accordance with	IEC61643-1:2005 ; UL1449 3rd									
Category IEC/VDE	I+II / B+C									
Max. continuous operating voltage (AC/DC)	150/200	175/225	275/300	300/385	320/420	385/505	440/585	550/745	600/800	150/200
Nominal discharge current (8/20) In	60KA									
Max. discharge current(8/20) Imax	120KA									
Lightning impulse current (10/350) Iimp	12.5KA									
Voltage protection level at In	0.8KV	0.8KV	1.3KV	1.4KV	1.5KV	1.8KV	2.1KV	2.8KV	3.0KV	0.8KV
Let through voltage @3KA 8/20	0.5KV	0.6KV	0.9KV	1.0KV	1.1KV	1.3KV	1.5KV	2.0KV	2.0KV	0.5KV
Response time	≤25 ns									
Follow current	No									
Backup fuse <small>(only required if not already provided in mains)</small>	315A gL/gG									
Operating temperature range	- 40°C~ + 80°C									
Cross-section of connection wire	Single-strand 35mm ² ; multi-strand 25mm ²									
Mounting	35mm DIN-rail in accordance with EN 50022/DIN46277-3									
Enclosure material	Thermoplastic ; extinguishing degree UL94 V-0									
Degree of protection	IP20									
Installation width	2 modules , DIN 43880									
Thermal disconnecter	Internal green – normal red - failure									
Remote alarm contact	Optional									
Additional data for Remote Alarm Contacts										
Remote alarm contact type	floating changeover contact									
Switching capability UN/IN	AC: 250V/0.5A					DC: 250V/0.1A ; 125V/0.2A ; 75V/0.5A				
ross-section of connection wire	Max. 1.5mm ²									

Note: Subject to change without any notice.

MOV Module Surge Protection Devices Type MV150/***-R

- Class I+II (B+C) arrester in according with IEC61643-1:2005.
- Two part design consisting of base and non-pluggable protection module.
- High energy MOV (Metal Oxide Varistor) inside.
- Reliable supervision due to disconnection device.
- Fault indication by red indication flag in window.
- Fast response.
- With remote alarm terminal optional.

Dimensions and Diagram

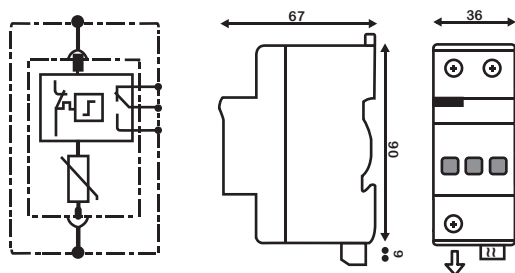

Surge arrester for low-voltage power supply system protection against surges at the boundaries from lightning protection zone 0B-1 and higher.

Characteristics

Type	MV 150/***-R									
	150	175	275	300	320	385	440	550	600	
In accordance with	IEC61643-1:2005 ; UL1449 3rd									
Category IEC/VDE	I+II / B+C									
Max. continuous operating voltage (AC/DC)	150/ 200	175/ 225	275/ 300	300/ 385	320/ 420	385/ 505	440/ 585	550/ 745	600/ 800	
Nominal discharge current (8/20) In	70KA	70KA	70KA	70KA	70KA	70KA	70KA	70KA	70KA	
Max. discharge current(8/20) Imax	150KA									
Lightning impulse current (10/350) Iimp	25KA									
Voltage protection level at In	0.8KV	0.8KV	1.3KV	1.4KV	1.5KV	1.8KV	2.1KV	2.8KV	3.0KV	
Let through voltage @3KA 8/20	0.5KV	0.6KV	0.9KV	1.0KV	1.1KV	1.3KV	1.5KV	2.0KV	2.0KV	
Response time	≤25 ns									
Follow current	No									
Backup fuse (only required if not already provided in mains)	315A gL/gG									
Operating temperature range	- 40°C ~ + 80°C									
Cross-section of connection wire	Single-strand 35mm ² ; multi-strand 25mm ²									
Mounting	35mm DIN-rail in accordance with EN 50022/DIN46277-3									
Enclosure material	Thermoplastic ; extinguishing degree UL94 V-0									
Degree of protection	IP20									
Installation width	2 modules , DIN 43880									
Thermal disconnecter	Internal green – normal red - failure									
Remote alarm contact	Optional									
Additional data for Remote Alarm Contacts										
Remote alarm contact type	floating changeover contact									
Switching capability UN/IN	AC: 250V/0.5A DC: 250V/0.1A ; 125V/0.2A ; 75V/0.5A									
Cross-section of connection wire	Max. 1.5mm ²									

Note: Subject to change without any notice.

MOV Module Surge Protection Devices Type MV200/***-R

- Class I+II (B+C) arrester in according with IEC61643-1:2005.
- Two part design consisting of base and non-pluggable protection module.
- High energy MOV (Metal Oxide Varistor) inside.
- Reliable supervision due to disconnection device.
- Fault indication by red indication flag in window.
- Fast response.
- With remote alarm terminal optional.

Dimensions and Diagram

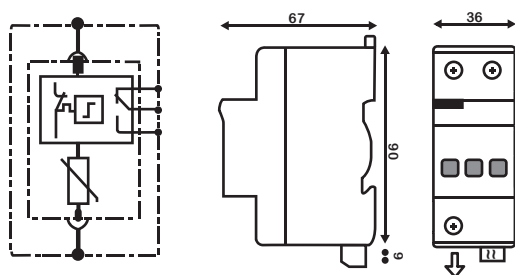

Surge arrester for low-voltage power supply system protection against surges at the boundaries from lightning protection zone 0B-1 and higher.

Characteristics

Type	MV 200/***-R									
	150	175	275	300	320	385	440	550	600	150
In accordance with	IEC61643-1:2005 ; UL1449 3rd									
Category IEC/VDE	I+II / B+C									
Max. continuous operating voltage (AC/DC)	150/200	175/225	275/300	300/385	320/420	385/505	440/585	550/745	600/800	150/200
Nominal discharge current (8/20) In	70KA									
Max. discharge current (8/20) Imax	200KA									
Lightning impulse current (10/350) Iimp	35KA									
Voltage protection level at In	0.8KV	0.8KV	1.3KV	1.4KV	1.5KV	1.8KV	2.1KV	2.8KV	3.0KV	0.8KV
Let through voltage @3KA 8/20	0.5KV	0.6KV	0.9KV	1.0KV	1.1KV	1.3KV	1.5KV	2.0KV	2.0KV	0.5KV
Response time	≤25 ns									
Follow current	No									
Backup fuse <small>(only required if not already provided in mains)</small>	315A gL/gG									
Operating temperature range	- 40°C ~ + 80°C									
Cross-section of connection wire	Single-strand 35mm ² ; multi-strand 25mm ²									
Mounting	35mm DIN-rail in accordance with EN 50022/DIN46277-3									
Enclosure material	Thermoplastic ; extinguishing degree UL94 V-0									
Degree of protection	IP20									
Installation width	2 modules , DIN 43880									
Thermal disconnecter	Internal green – normal red - failure									
Remote alarm contact	Optional									
Additional data for Remote Alarm Contacts										
Remote alarm contact type	floating changeover contact									
Switching capability UN/IN	AC: 250V/0.5A					DC: 250V/0.1A ; 125V/0.2A ; 75V/0.5A				
Cross-section of connection wire	Max. 1.5mm ²									

Note: Subject to change without any notice.

Multi-Air-Gap Module Lightning current arrester Type SG15/***

- Class I (B) arrester in according with IEC61643-1:2001.
- Tested with lightning impulse current (10/350) in according with IEC61643- 1:2001.
- Multi-Air-Gap technology, no leakage current and follow current.
- Maximum energy capability.
- Low voltage protection level.
- Fast response.
- Single pole version permits the installation in up to four poles depending on the type of power system.



Dimensions and Diagram

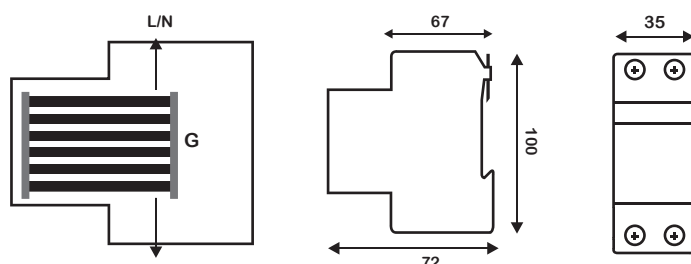

Characteristics

Type	SG 15/***			
	150	255	350	440
In accordance with	IEC61643-1:2001			
Category IEC / VDE	I / B			
Max. continuous operating voltage Uc	150	255	350	440
Max. discharge current(8/20) I _{max}	100KA			
Lightning impulse current (10/350) I _{imp}	15KA			
Voltage protection level at 1kV/μS	2.5KV			
Response time	≤100 ns			
Leakage current	No			
Follow current	No			
Insulation resistance	≥10 ³ MΩ			
Operating temperature range	- 40°C ... + 80°C			
Cross-section of connection wire	Single-strand 35mm ² ; multi-strand 25mm ²			
Mounting	35mm DIN-rail in accordance with EN 50022 / DIN46277-3			
Installation width	2 modules , DIN 43880			
Enclosure material	Thermoplastic ; extinguishing degree UL94 V-0			
Degree of protection	IP20			

Note: Subject to change without any notice.

Surge arrester for low-voltage power supply system protection against direct lightning strikes and surges at the boundaries from lightning protection zone 0A-1.

Multi-Air-Gap Module Lightning current arrester Type SG25/***

- Class I (B) arrester in according with IEC61643-1:2001.
- Tested with lightning impulse current (10/350) in according with IEC61643- 1:2001.
- Multi-Air-Gap technology, no leakage current and follow current.
- Maximum energy capability.
- Low voltage protection level.
- Fast response.
- Single pole version permits the installation in up to four poles depending on the type of power system.



Dimensions and Diagram

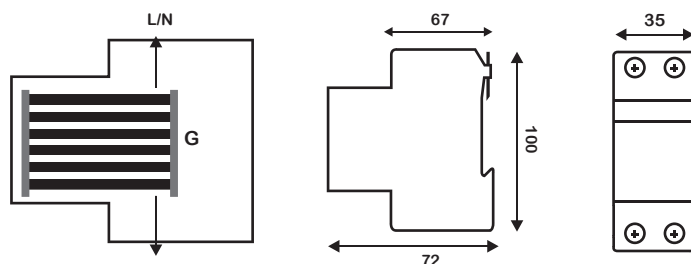

Characteristics

Type	SG 25/***			
	150	255	350	440
In accordance with	IEC61643 - 1:2001			
Category IEC / VDE	I / B			
Max. continuous operating voltage Uc	150	255	350	440
Max. discharge current(8/20) I _{max}	120KA			
Lightning impulse current (10/350) I _{imp}	25KA			
Voltage protection level at 1kV/μS	2.5KV			
Response time	≤100 ns			
Leakage current	No			
Follow current	No			
Insulation resistance	≥10 ³ MΩ			
Operating temperature range	- 40°C ... + 80°C			
Cross-section of connection wire	Single-strand 35mm ² ; multi-strand 25mm ²			
Mounting	35mm DIN-rail in accordance with EN 50022 / DIN46277-3			
Installation width	2 modules , DIN 43880			
Enclosure material	Thermoplastic ; extinguishing degree UL94 V-0			
Degree of protection	IP20			

Note: Subject to change without any notice.

Surge arrester for low-voltage power supply system protection against direct lightning strikes and surges at the boundaries from lightning protection zone 0A-1.

AC Surge Protective Devices

Type 1/Class I Surge Protective Devices for LV Power System

IEC61643 - 1:2005

- Spark gap technology
- Iimp 25~100KA (10/350µs)
- Imax up to 200KA(8/20µs)
- Low voltage protection level (Up)
- Fault indication optional
- With remote signaling contact optional
- Non-pluggable type design to avoid flashover happen at the contacts between pluggable module and base under high surge current.

Dimensions and Diagram

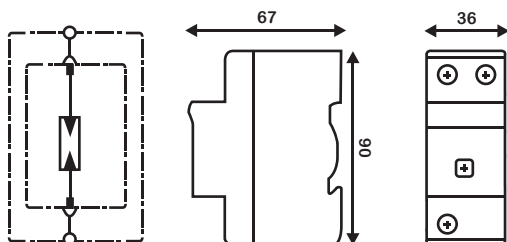

Characteristics

SG50/***					SG100/***				
Category IEC	I				Category IEC	I			
Max. continuous operating voltage Uc	150	275	320	440	Max. continuous operating voltage Uc	150	255	350	440
Nominal discharge current(8/20) In	50KA				Nominal discharge current(8/20) In	100KA			
Lightning impulse current (10/350) Iimp	50KA				Lightning impulse current (10/350) Iimp	100KA			
Voltage protection level (Up)	1.0KV	1.5KV	1.5KV	2.0KV	Voltage protection level (Up)	1.0KV	1.5KV	1.8KV	2.0KV
Response time	≤100 ns				Response time	≤100 ns			
Short circuit withstand and follow up current extinguishing capacity without back up fuse	Isc≥25KA				Short circuit withstand and follow up current extinguishing capacity without back up fuse	If:≥100Arms @ Uc			
Operating temperature range/RH	- 40°C ~ + 80°C / 95% humidity				Operating temperature range/RH	- 40°C ~ + 80°C / 95% humidity			
Cross-section of connection wire	Single-strand 35mm ² ; multi-strand 25mm ²				Cross-section of connection wire	Single-strand 35mm ² ; multi-strand 25mm ²			
Mounting	35mm DIN-rail in accordance with EN 50022/DIN46277-3				Mounting	35mm DIN-rail in accordance with EN 50022/DIN46277-3			
Backup Fuse (only required if not already provided in mains)	63 Amp				Backup Fuse (only required if not already provided in mains)	/			
Installation width	2 modules, DIN 43880				Installation width	2 modules, DIN 43880			
Enclosure material	thermoplastic; extinguishing degree UL94 V-0				Enclosure material	thermoplastic; extinguishing degree UL94 V-0			
Indication function	Optional				Indication function	Optional			
Degree of protection	IP20				Degree of protection	IP20			
Technology	Spark Gap				Technology	Spark Gap			

Note: Subject to change without any notice.

GDT Module Surge Protective Devices Type GT25/***

Rapid thermal disconnection under TOV ;
Inbuilt Arc - extinguishing device.

- Class II (C) arrester in according with IEC61643-1:2005.
- Two part design consisting of base and plug-in protection module.
- High energy GDT (Gas Discharge Tube) inside.
- Reliable supervision due to disconnection device.
- Fault indication by red indication flag in window.
- No leakage current.
- With remote alarm terminal optional.



Dimensions and Diagram

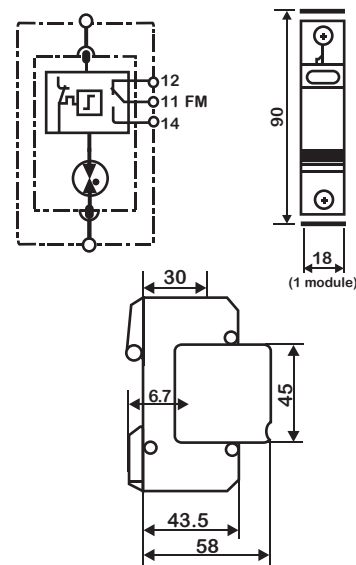

Characteristics

Type	GT 25 /***			
	150	255	350	440
In accordance with	IEC61643-1:2005 ; UL1449 3rd			
Category IEC / VDE	II / C			
Max. continuous operating voltage Uc	150	255	350	440
Nominal discharge current(8/20) In	15KA			
Max. discharge current(8/20) Imax	25KA			
DC Sparkover voltage	350	600	800	1000
Voltage protection level at 1.2/50	0.8KV	1.5KV	1.5KV	1.6KV
Response time	≤100 ns			
Follow current If	100Arms @ Uc			
Insulation resistance	≥103 MΩ			
Operating temperature range	- 40°C~ + 80°C			
Cross-section of connection wire	Single-strand 35mm ² ; multi-strand 25mm ²			
Mounting	35mm DIN-rail in accordance with EN 50022 / DIN46277-3			
Enclosure material	Thermoplastic ; extinguishing degree UL94 V-0			
Degree of protection	IP20			
Installation width	1 module , DIN 43880			
Thermal disconnecter	Internal green – normal red - failure			
Remote alarm contact	Optional			
Additional data for Remote Alarm Contacts				
Remote alarm contact type	floating changeover contact			
Switching capability U _N /I _N	AC: 250V/0.5A		DC: 250V/0.1A ; 125V/0.2A ; 75V/0.5A	
Cross-section of connection wire	Max. 1.5mm ²			

Note: Subject to change without any notice.

Class II GDT Module Surge Protective Devices Type GT40/***

Rapid thermal disconnection under TOV ;
Inbuilt Arc - extinguishing device.

- Class II arrester in according with IEC61643-1:2005.
- Tested with lightning impulse current (10/350) and surge current (8/20) in according with IEC61643-1:2005.
- Two part design consisting of base and plug-in protection module.
- High energy GDT (Gas Discharge Tube) inside.
- Reliable supervision due to disconnection device.
- Fault indication by red indication flag in window.

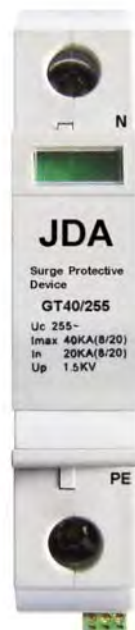

Dimensions and Diagram

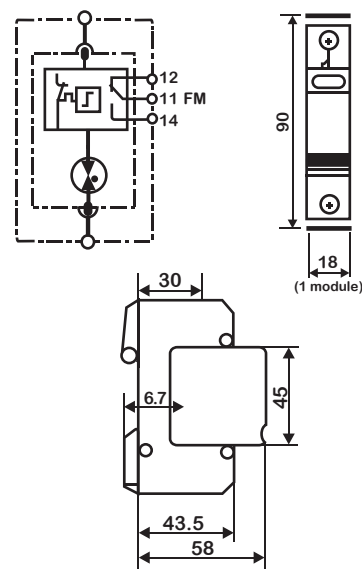

Characteristics

Type	GT40/***			
	150	255	350	440
In accordance with	IEC61643-1:2005 ; UL1449 3rd			
Category IEC	I+II			
Max. continuous operating voltage Uc	150	255	350	440
Nominal discharge current(8/20) In	20KA			
Max. discharge current(8/20) Imax	40KA			
DC Sparkover voltage	350V	600V	800V	1000V
Voltage protection level at 1.2/50	0.6KV	1.2KV	1.5KV	1.6KV
Response time	≤100 ns			
Follow current If	≥100Arms @ Uc			
Insulation resistance	≥10 ³ MΩ			
Operating temperature range	- 40°C~ + 80°C			
Cross-section of connection wire	Single-strand 35mm ² ; multi-strand 25mm ²			
Mounting	35mm DIN-rail in accordance with EN 50022/DIN46277-3			
Enclosure material	Thermoplastic ; extinguishing degree UL94 V-0			
Degree of protection	IP20			
Installation width	1 module , DIN 43880			
Thermal disconnecter	Internal green – normal red - failure			
Remote alarm contact	Optional			
Additional data for Remote Alarm Contacts				
Remote alarm contact type	floating changeover contact			
Switching capability U _N /I _N	AC: 250V/0.5A DC: 250V/0.1A ; 125V/0.2A ; 75V/0.5A			
Cross-section of connection wire	Max. 1.5mm ²			

Note: Subject to change without any notice.

GDT Module Surge Protective Devices Type GT50/***

Rapid thermal disconnection under TOV ;
Inbuilt Arc - extinguishing device.

- Class II (C) arrester in according with IEC61643-1:2005.
- Fail Safe System (Patent)
- Two part design consisting of base and plug-in protection module.
- High energy GDT (Gas Discharge Tube) inside.
- Reliable supervision due to disconnection device.
- Fault indication by red indication flag in window.
- No leakage current.
- With remote alarm terminal optional.



Dimensions and Diagram

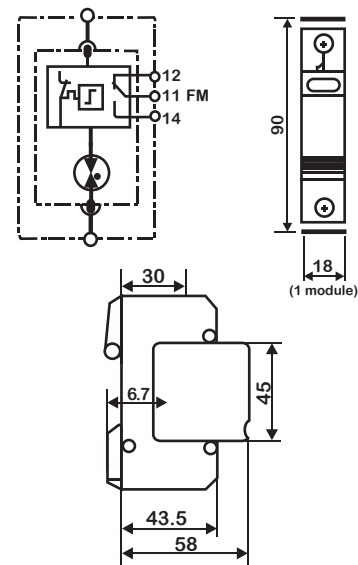

Characteristics

Type	GT 50/***			
	150	255	350	440
In accordance with	IEC61643-1:2005 ; UL1449 3rd			
Category IEC / VDE	II / C			
Max. continuous operating voltage Uc	150	255	350	440
Nominal discharge current (8/20) In	20KA			
Max. discharge current (8/20) Imax	50KA			
DC Sparkover voltage	350	600	800	1000
Voltage protection level at 1.2/50	0.8KV	1.5KV	1.5KV	1.6KV
Response time	≤100 ns			
Follow current If	100Arms @Uc			
Residual current at Uc	No			
Insulation resistance	≥103 MΩ			
Operating temperature range	- 40°C~ + 80°C			
Cross-section of connection wire	Single-strand 35mm ² ; multi-strand 25mm ²			
Mounting	35mm DIN-rail in accordance with EN 50022 / DIN46277-3			
Enclosure material	Thermoplastic ; extinguishing degree UL94 V-0			
Degree of protection	IP20			
Installation width	1 module , DIN 43880			
Thermal disconnect	Internal green – normal red - failure			
Remote alarm contact	Optional			
Additional data for Remote Alarm Contacts				
Remote alarm contact type	floating changeover contact			
Switching capability UN/IN	AC: 250V/0.5A		DC: 250V/0.1A ; 125V/0.2A ; 75V/0.5A	
Cross-section of connection wire	Max. 1.5mm ²			

Note: Subject to change without any notice.

GDT Module Surge Protective Devices Type GT60/***

Rapid thermal disconnection under TOV ;
Inbuilt Arc - extinguishing device.

- Class I+II (B+C) arrester in according with IEC61643-1:2005.
- Tested with lightning impulse current (10/350) and surge current (8/20) in according with IEC61643-1:2005.
- Two part design consisting of base and plug-in protection module.
- High energy GDT (Gas Discharge Tube) inside.
- Reliable supervision due to disconnection device.
- Fault indication by red indication flag in window.
- No leakage current.
- With remote alarm terminal optional.

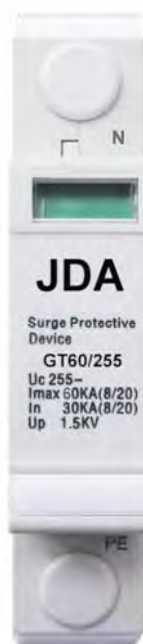

Dimensions and Diagram

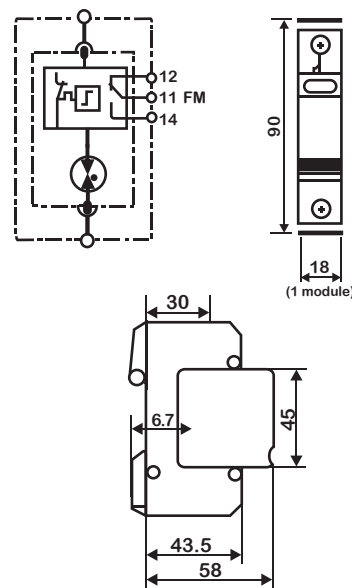

Characteristics

Type	GT 60/***			
	150	255	350	440
In accordance with	IEC61643-1:2005 ; UL1449 3rd			
Category IEC/VDE	I+II / B+C			
Max. continuous operating voltage Uc	150	255	350	440
Nominal discharge current(8/20) In	30KA			
Max. discharge current(8/20) Imax	60KA			
Lightning impulse current (10/350) Iimp	15KA			
DC Sparkover voltage	350V	600V	800V	1000V
Voltage protection level at 1.2/50	0.8KV	1.5KV	1.5KV	1.6KV
Response time	≤100 ns			
Follow current If	≥100Arms @ Uc			
Operating temperature range	- 40°C~ + 80°C			
Cross-section of connection wire	Single-strand 35mm ² ; multi-strand 25mm ²			
Mounting	35mm DIN-rail in accordance with EN 50022/DIN46277-3			
Enclosure material	Thermoplastic ; extinguishing degree UL94 V-0			
Degree of protection	IP20			
Installation width	1 module , DIN 43880			
Thermal disconnecter	Internal green – normal red - failure			
Remote alarm contact	Optional			
Additional data for Remote Alarm Contacts				
Remote alarm contact type	floating changeover contact			
Switching capability U _N /I _N	AC: 250V/0.5A		DC: 250V/0.1A ; 125V/0.2A ; 75V/0.5A	
Cross-section of connection wire	Max. 1.5mm ²			

Note: Subject to change without any notice.

GDT Module Surge Protection Devices Type GT80/***

Surge arrester for low-voltage power supply system protection against surges at the boundaries from lightning protection zone 0B-1 and higher.

- Class I+II (B+C) arrester in according with IEC61643-1:2005.
- Tested with lightning impulse current (10/350) and surge current (8/20) in according with IEC61643- 1:2005.
- Two part design consisting of base and plug-in module.
- High energy GDT (Gas Discharge Tube) inside.
- Reliable supervision due to disconnection device.
- Fault indication by red indication flag in window.
- No leakage current.
- With remote alarm terminal optional.



Characteristics

Type	GT 80/***			
	150	255	350	440
In accordance with	IEC61643-1:2005 ; UL1449 3rd			
Category IEC / VDE	I+II / B+C			
Max. continuous operating voltage Uc	150	255	350	440
Nominal discharge current(8/20) In	40KA			
Max. discharge current(8/20) Imax	80KA			
Lightning impulse current (10/350) Iimp	25KA			
DC Sparkover voltage	350V	600V	800V	1000V
Voltage protection level at 1.2/50	0.8KV	1.5KV	1.5KV	1.6KV
Response time	≤100 ns			
Follow current If @ Uc	100Arms			
Insulation resistance	≥10 ³ MΩ			
Operating temperature range	- 40°C~ + 80°C			
Cross-section of connection wire	Single-strand 35mm ² ; multi-strand 25mm ²			
Mounting	35mm DIN-rail in accordance with EN 50022 / DIN46277-3			
Enclosure material	Thermoplastic ; extinguishing degree UL94 V-0			
Degree of protection	IP20			
Installation width	2 modules , DIN 43880			
Thermal disconnecter	Internal green – normal red - failure			
Remote alarm contact	Optional			
Additional data for Remote Alarm Contacts				
Remote alarm contact type	floating changeover contact			
Switching capability UN/IN	AC: 250V/0.5A	DC: 250V/0.1A ; 125V/0.2A ; 75V/0.5A		
Cross-section of connection wire	Max. 1.5mm ²			

Dimensions and Diagram

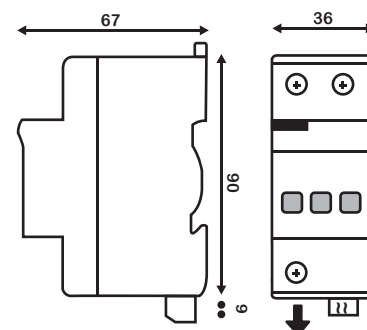
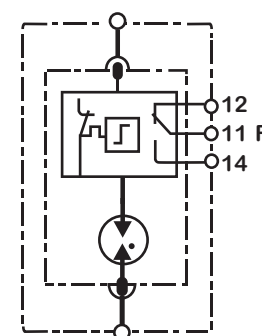

All Dimensions in mm

Note: Subject to change without any notice.

GDT Module Surge Protection Devices Type GT100/***

Surge arrester for low-voltage power supply system protection against surges at the boundaries from lightning protection zone 0B-1 and higher.

- Class I+II (B+C) arrester in according with IEC61643-1:2005.
- Tested with lightning impulse current (10/350) and surge current (8/20) in according with IEC61643-1:2005.
- Two part design consisting of base and non-pluggable protection module.
- High energy GDT (Gas Discharge Tube) inside.
- Reliable supervision due to disconnection device.
- Fault indication by red indication flag in window.
- No leakage current.
- With remote alarm terminal optional.



Characteristics

Type	GT 100/***			
	150	255	350	440
In accordance with	IEC61643-1:2005 ; UL1449 3rd			
Category IEC / VDE	I+II / B+C			
Max. continuous operating voltage Uc	150	255	350	440
Nominal discharge current(8/20) In	50KA			
Max. discharge current(8/20) Imax	100KA			
Lightning impulse current (10/350) Iimp	25KA			
DC Sparkover voltage	350V	600V	800V	1000V
Voltage protection level at 1.2/50	0.8KV	1.5KV	1.5KV	1.6KV
Response time	≤100 ns			
Follow current If at Uc	100Arms			
Insulation resistance	≥10 ³ MΩ			
Operating temperature range	- 40°C~ + 80°C			
Cross-section of connection wire	Single-strand 35mm ² ; multi-strand 25mm ²			
Mounting	35mm DIN-rail in accordance with EN 50022 / DIN46277-3			
Enclosure material	Thermoplastic; extinguishing degree UL94 V-0			
Degree of protection	IP20			
Installation width	2 modules, DIN 43880			
Thermal disconnecter	Internal green – normal red - failure			
Remote alarm contact	Optional			
Additional data for Remote Alarm Contacts				
Remote alarm contact type	floating changeover contact			
Switching capability UN/IN	AC: 250V/0.5A	DC: 250V/0.1A ; 125V/0.2A ; 75V/0.5A		
Cross-section of connection wire	Max. 1.5mm ²			

Dimensions and Diagram

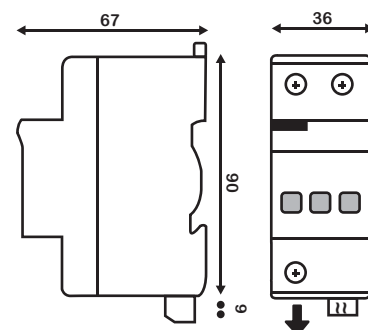
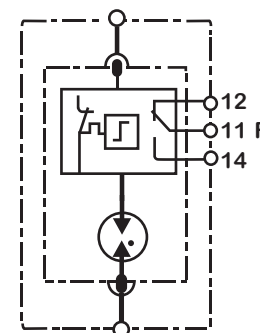

All Dimensions in mm

Note: Subject to change without any notice.

GDT Module Surge Protection Devices

Type GT120/***

Surge arrester for low-voltage power supply system protection against surges at the boundaries from lightning protection zone 0B-1 and higher.

- Class I+II (B+C) arrester in according with IEC61643-1:2005.
- Tested with lightning impulse current (10/350) and surge current (8/20) in according with IEC61643- 1:2005.
- Two part design consisting of base and non-pluggable protection module.
- High energy GDT (Gas Discharge Tube) inside.
- Reliable supervision due to disconnection device.
- Fault indication by red indication flag in window.
- No leakage current.
- With remote alarm terminal optional.



Characteristics

Type	GT 120/***			
	150	255	350	440
In accordance with	IEC61643-1:2005 ; UL1449 3rd			
Category IEC / VDE	I+II / B+C			
Max. continuous operating voltage Uc	150	255	350	440
Nominal discharge current (8/20) In	60KA			
Max. discharge current (8/20) Imax	120KA			
Lightning impulse current (10/350) Iimp	30KA			
DC Sparkover voltage	350	600	800	1000
Voltage protection level at 1.2/50	0.8KV	1.5KV	1.5KV	1.6KV
Response time	≤100 ns			
Follow current If at Uc	100Arms			
Insulation resistance	≥10 ³ MΩ			
Operating temperature range	- 40°C~ + 80°C			
Cross-section of connection wire	Single-strand 35mm ² ; multi-strand 25mm ²			
Mounting	35mm DIN-rail in accordance with EN 50022 /DIN46277-3			
Enclosure material	Thermoplastic ; extinguishing degree UL94 V-0			
Degree of protection	IP20			
Installation width	2 modules , DIN 43880			
Thermal disconnecter	Internal green – normal red - failure			
Remote alarm contact	Optional			
Additional data for Remote Alarm Contacts				
Remote alarm contact type	floating changeover contact			
Switching capability UN/IN	AC: 250V/0.5A	DC: 250V/0.1A ; 125V/0.2A ; 75V/0.5A		
Cross-section of connection wire	Max. 1.5mm ²			

Dimensions and Diagram

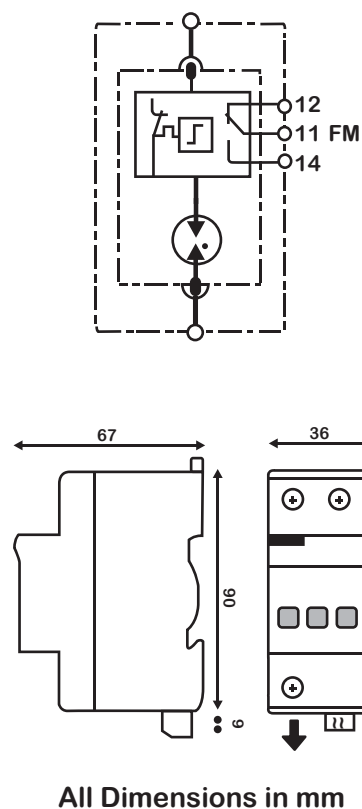

Note: Subject to change without any notice.

GDT Module Surge Protection Devices Type GT150/***

Surge arrester for low-voltage power supply system protection against surges at the boundaries from lightning protection zone 0B-1 and higher.

- Class I+II (B+C) arrester in according with IEC61643-1:2005.
- Tested with lightning impulse current (10/350) and surge current (8/20) in according with IEC61643-1:2005.
- Two part design consisting of base and protection module including plug-in module and non-pluggable module.
- High energy GDT (Gas Discharge Tube) inside.
- Reliable supervision due to disconnection device.
- Fault indication by red indication flag in window.
- No leakage current.
- With remote alarm terminal optional.



Characteristics

Type	GT 150/***			
	150	255	350	440
In accordance with	IEC61643-1:2005 ; UL1449 3rd			
Category IEC/VDE	I+II / B+C			
Max. continuous operating voltage Uc	150	255	350	440
Nominal discharge current(8/20) In	70KA	70KA	70KA	70KA
Max. discharge current(8/20) Imax	150KA			
Lightning impulse current (10/350) Iimp	35KA			
DC Sparkover voltage	350V	600V	800V	1000V
Voltage protection level at 1.2/50	0.8KV	1.2KV	1.4KV	1.6KV
Response time	≤100 ns			
Follow current If at Uc	100Arms			
Insulation resistance	≥10 ³ M ^Ω			
Operating temperature range	- 40°C~ + 80°C			
Cross-section of connection wire	Single-strand 35mm ² ; multi-strand 25mm ²			
Mounting	35mm DIN-rail in accordance with EN 50022/DIN46277-3			
Enclosure material	Thermoplastic ; extinguishing degree UL94 V-0			
Degree of protection	IP20			
Installation width	2 modules , DIN 43880			
Thermal disconnecter	Internal green – normal red - failure			
Remote alarm contact	Optional			
Additional data for Remote Alarm Contacts				
Remote alarm contact type	floating changeover contact			
Switching capability Un/In	AC: 250V/0.5A DC: 250V/0.1A ; 125V/0.2A ; 75V/0.5A			
Cross-section of connection wire	Max. 1.5mm ²			

Dimensions and Diagram

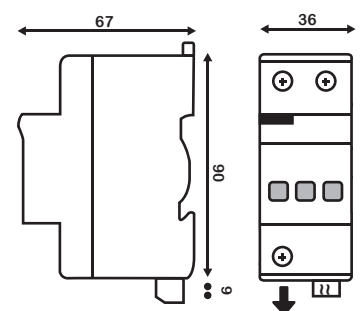
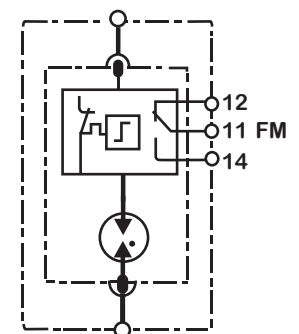

All Dimensions in mm

Note: Subject to change without any notice.

GDT Module Surge Protection Devices

Type GT200/***

Surge arrester for low-voltage power supply system protection against surges at the boundaries from lightning protection zone 0B-1 and higher.

- Class I+II (B+C) arrester in according with IEC61643-1:2005.
- Tested with lightning impulse current (10/350) and surge current (8/20) in according with IEC61643-1:2005.
- Two part design consisting of base and protection module including plug-in module and non-pluggable module.
- High energy GDT (Gas Discharge Tube) inside.
- Reliable supervision due to disconnection device.
- Fault indication by red indication flag in window.
- No leakage current.
- With remote alarm terminal optional.



Characteristics

Type	GT 200/***			
	150	255	350	440
In accordance with	IEC61643-1:2005 ; UL1449 3rd			
Category IEC / VDE	I+II / B+C			
Max. continuous operating voltage Uc	150	255	350	440
Nominal discharge current(8/20) In	100KA			
Max. discharge current(8/20) Imax	200KA			
Lightning impulse current (10/350) Iimp	50KA			
DC Sparkover voltage	350V	600V	800V	1000V
Voltage protection level at 1.2/50	0.8KV	1.5KV	1.5KV	1.6KV
Response time	≤100 ns			
Follow current If at Uc	100Arms			
Insulation resistance	≥10 ³ MΩ			
Operating temperature range	- 40°C~ + 80°C			
Cross-section of connection wire	Single-strand 35mm ² ; multi-strand 25mm ²			
Mounting	35mm DIN-rail in accordance with EN 50022 / DIN46277-3			
Enclosure material	Thermoplastic ; extinguishing degree UL94 V-0			
Degree of protection	IP20			
Installation width	2 modules , DIN 43880			
Thermal disconnecter	Internal green – normal red – failure			
Remote alarm contact	Optional			
Additional data for Remote Alarm Contacts				
Remote alarm contact type	floating changeover contact			
Switching capability UN/IN	AC: 250V/0.5A		DC: 250V/0.1A ; 125V/0.2A ; 75V/0.5A	
Cross-section of connection wire	Max. 1.5mm ²			

Dimensions and Diagram

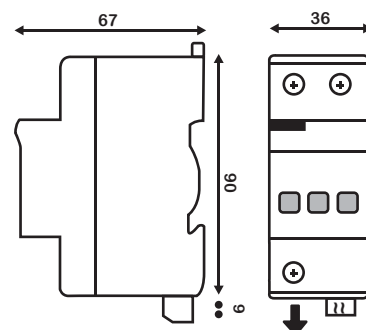
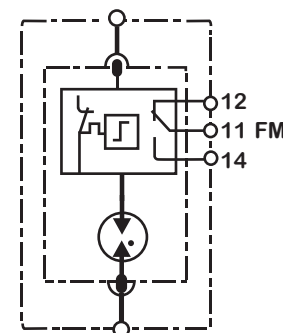

All Dimensions in mm

Note: Subject to change without any notice.

Data Network Protector

Type DN-*/B0

Signaling and Data Line Protector

Type:

DN-05/B0
DN-12/B0
DN-24/B0
DN-48/B0

IEC61643:21

- Signal transmission is not interrupted when exchanging module
- Two-stage protection circuit.
- 35 mm DIN-rail mounting design



Characteristics

Model No.	DN-05/B0	DN-12/B0	DN-24/B0	DN-48/B0
Nominal Voltage (V)	5	12	24	48
Max. Continuous AC Voltage (V) U _c AC/DC	5/6	12/15	24/28	48/60
Total nominal Discharge Current (8/20μs) I _n	5KA per line			
Lightning Imp. Current (10/350μs) I _{imp}	2.5KA			
Rated load current (A) I _L	≥250mA			
Voltage protection level (1KV/μs,V) U _p	≤10V	≤18V	≤30V	≤70V
Series impedance per line (Ohm)	4 Ohm			
Insertion loss at 100MHz (dB)	≤3.0			
Degree of protection	IP20			
Mounting on	35 mm DIN-rail			
Enclosure Material	UL94 V0			
Environment Temperature (°C)	- 40~+80			
Indication function	Optional			
Pluggable/Non-pluggable	Pluggable			
Technology	Combination of gas discharge tube & diodes with voltage & current limiting facilities.			

Note: Subject to change without any notice.

Passive Lightning Event Count Type surgeCon SEC

Passive Lightning Event Count

- Long service life due to No battery need.
- Maintenance free.
- Counting accurately
- Sensitive response and wide lightning current measuring range
- Easy to install and use, a simple insertion of the down conductor through the device.
- Can be used together with all kinds of lightning protectors and equipment.

Passive Lightning event counter is used for testing the lightning event in a certain area.



Characteristics

Type	surgeCon SEC
Counting Current (rise time $\geq 8\mu\text{s}$)	> 0.5 KA
Sequence of impulse	> 1s
Display Model	Electromechanical digital display
Indicator	Lightning Event 0~999999
Current Sample Mode	Inductive Probe (Built-in)
Working mode	No battery need
Operation temperature ($^{\circ}\text{C}$)	-20~ + 60
Dimension of through hole (mm)	32
Dimension of counter (mm)	150 x 78.5 x 34
Enclosure material	Steel
Degree of protection	IP67

Note: Subject to change without any notice.

Connection

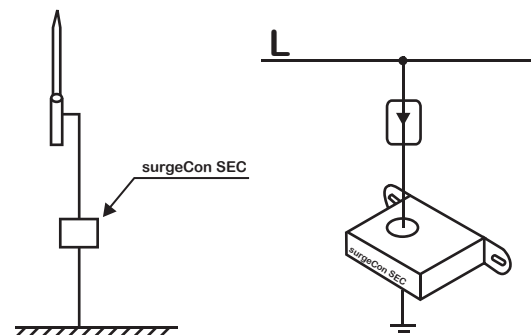
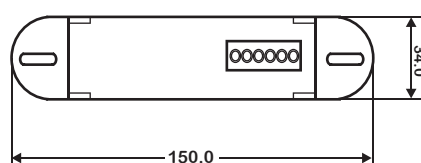
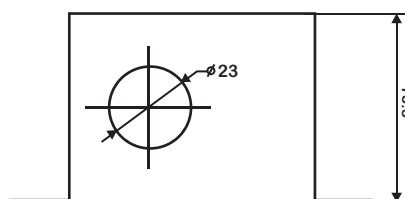

Surge Protective Device Wiring

3 - Phase network

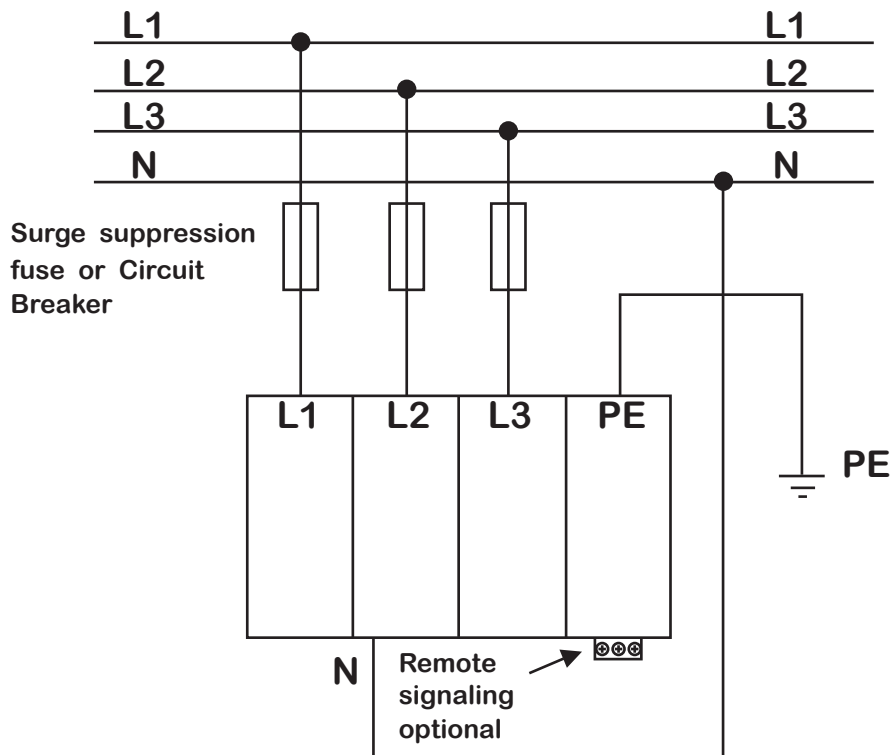
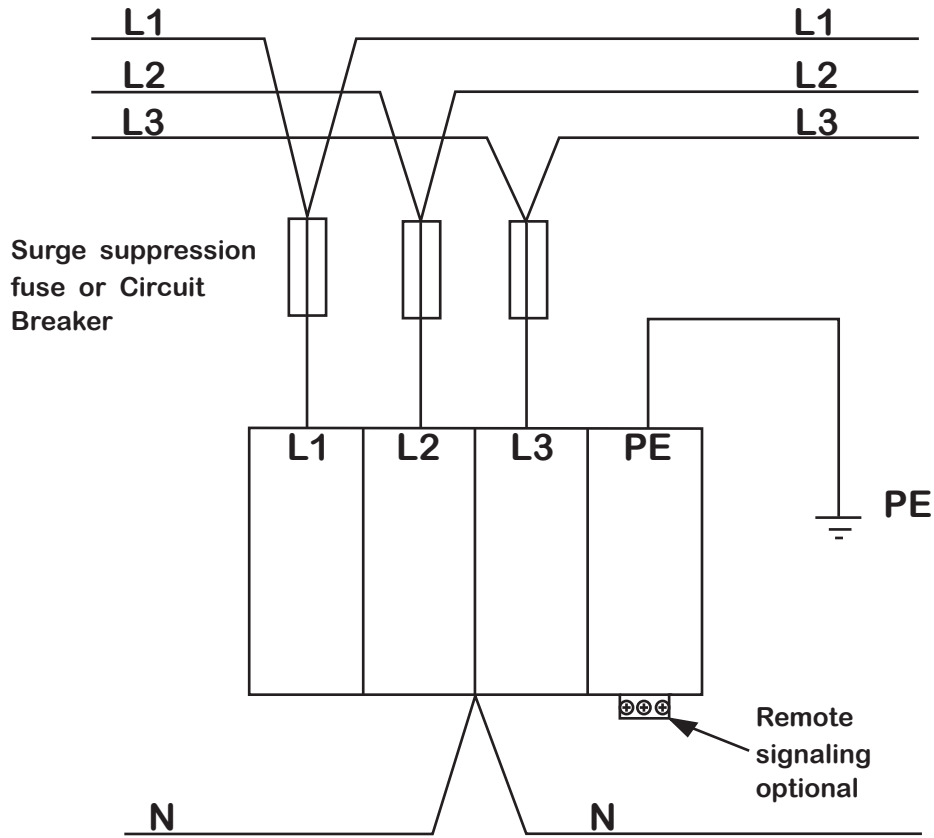

Note: Subject to change without any notice.

SPD wiring for different power systems

Type TN-C-S system / TT system

TN-C-S system:

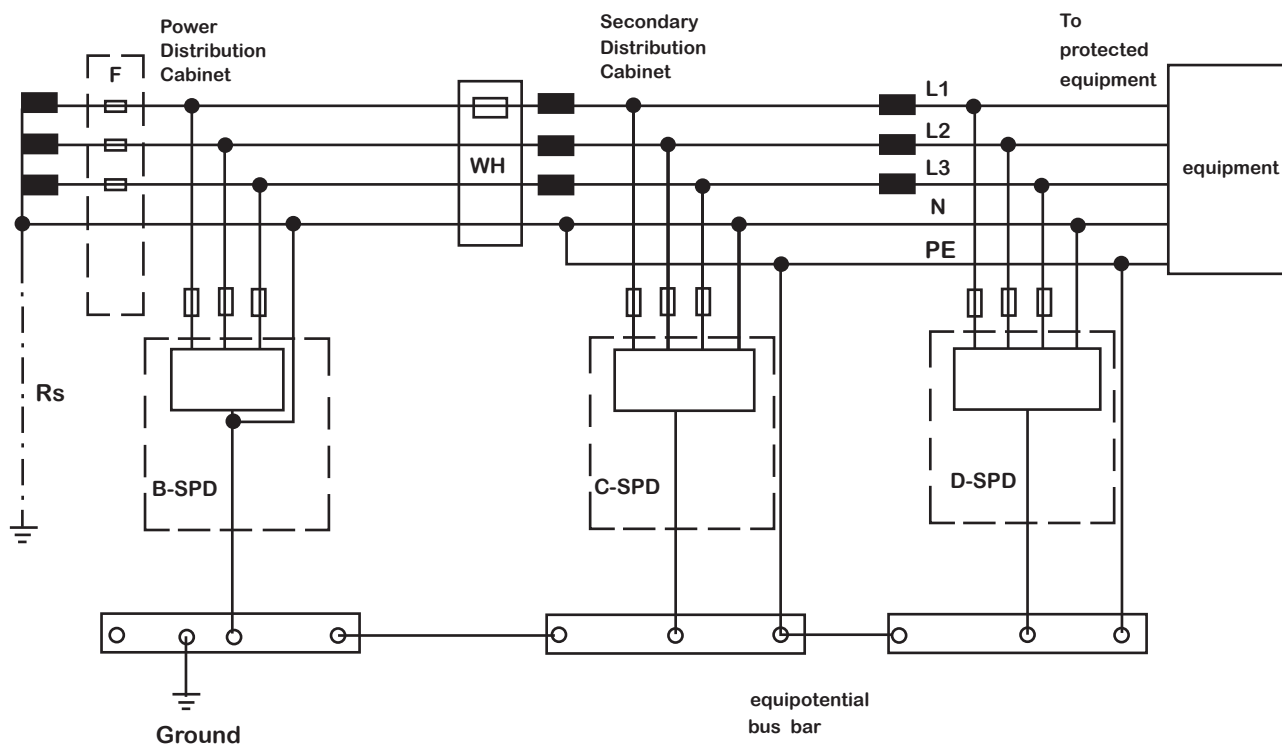

TN-C-S system

TT system:

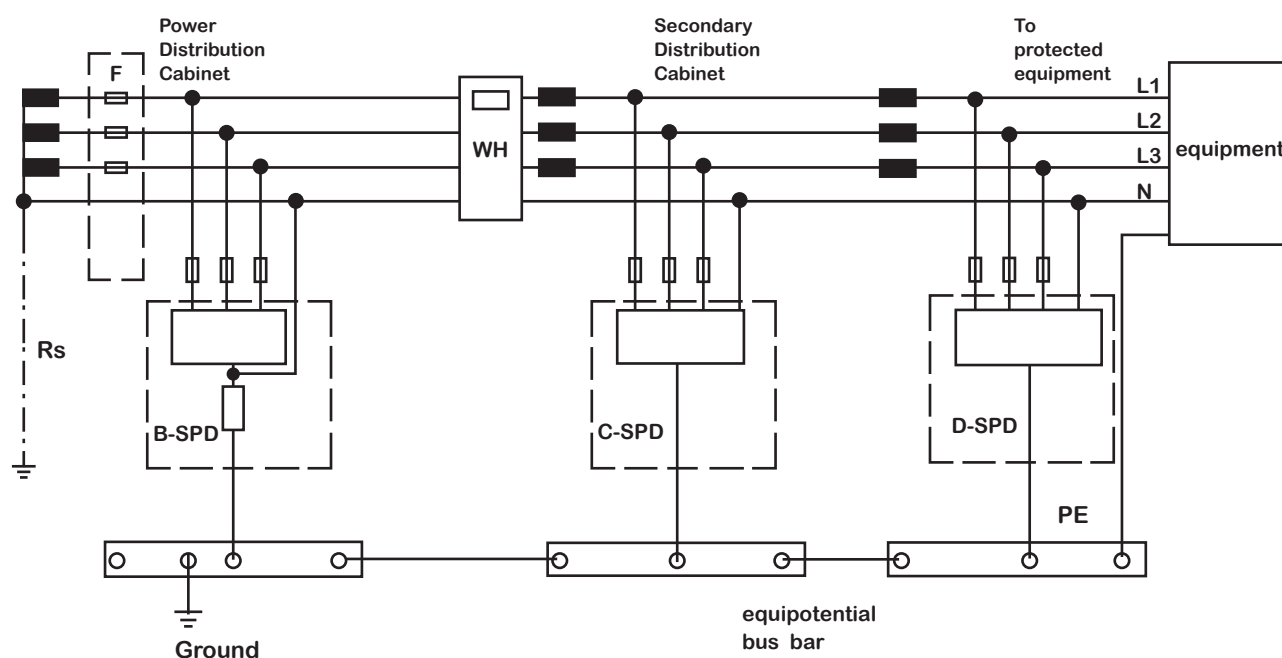

TT system

Note: Subject to change without any notice.

SPD wiring for different power systems

Type TN-S system / TN-C system

TN-S system:

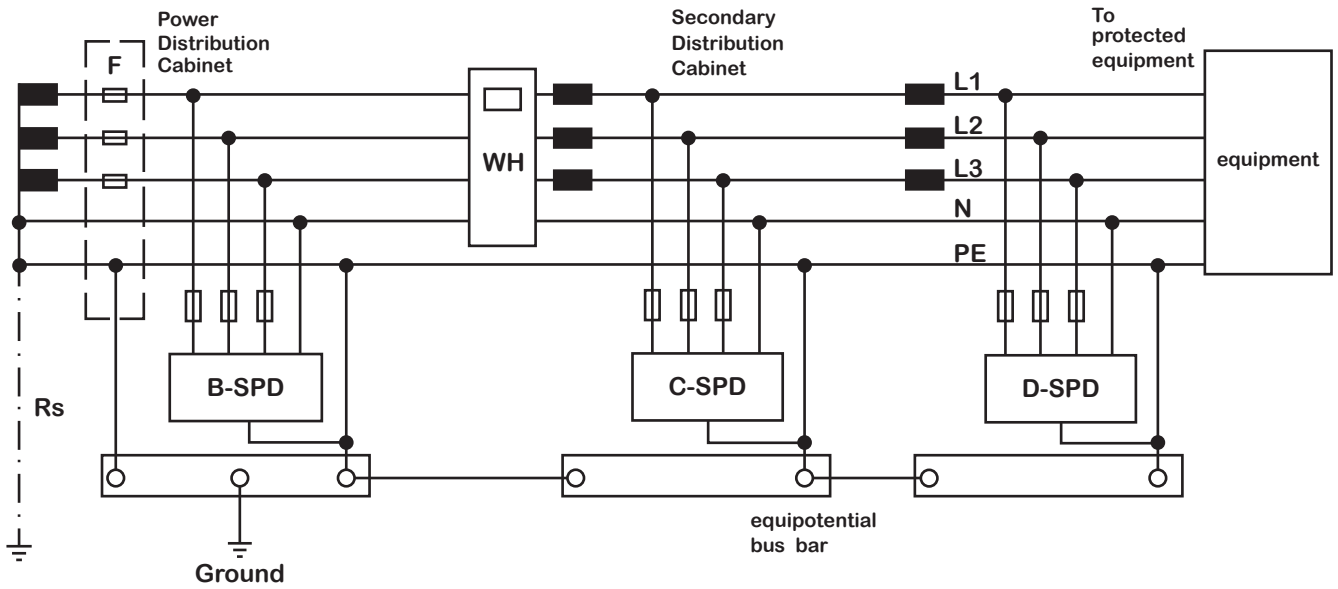

TN-S system

TN-C system:

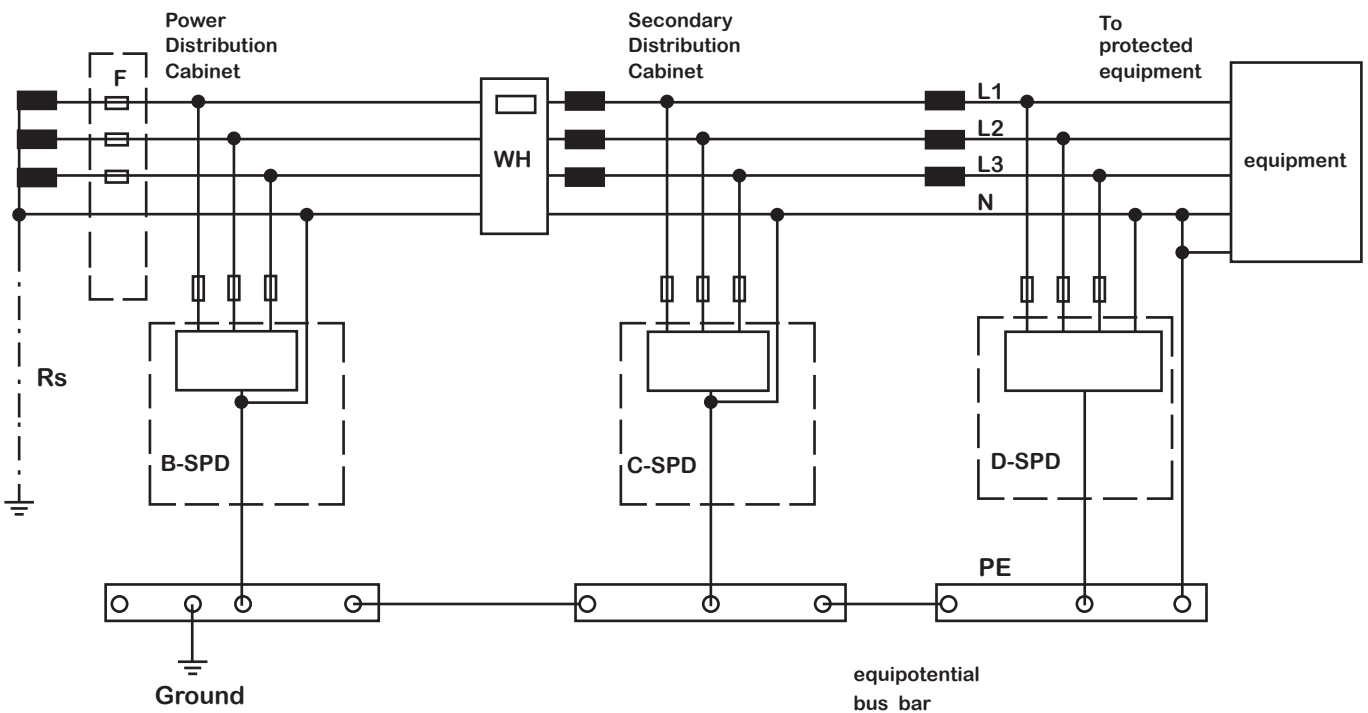

TN-C system

Note: Subject to change without any notice.

SPD wiring for different power systems

Type IT system / Choose SPD configuration

IT system:

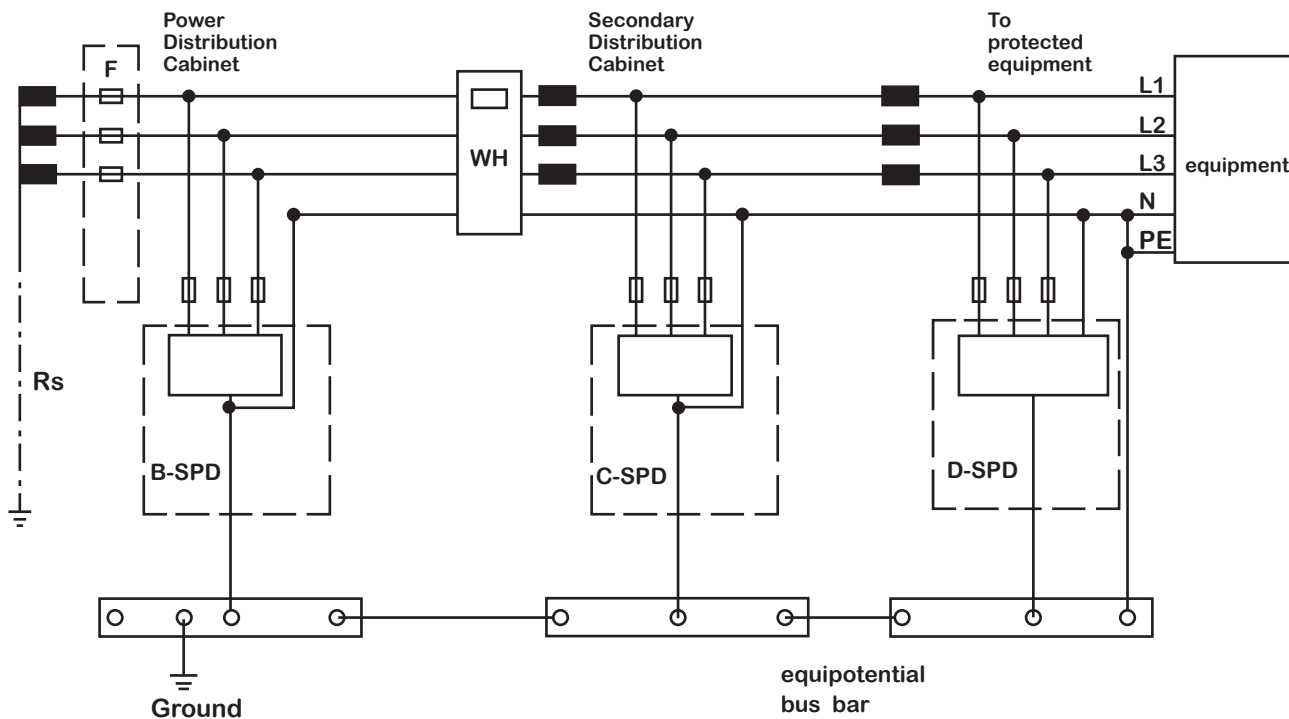

IT system

Choose SPD configuration

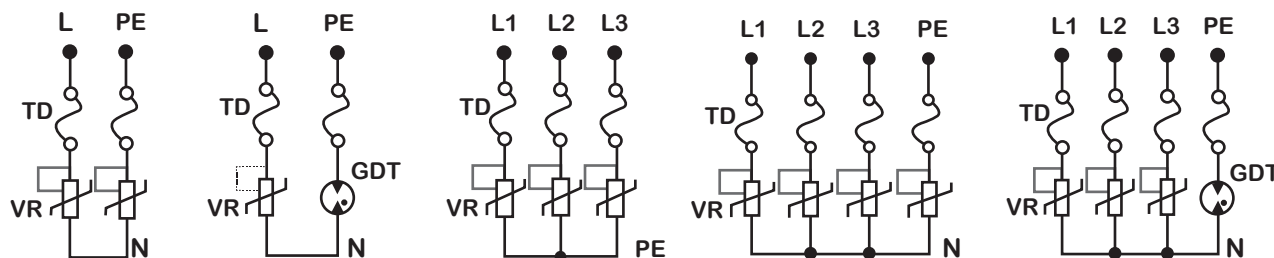

Note: Subject to change without any notice.

